

User Guide

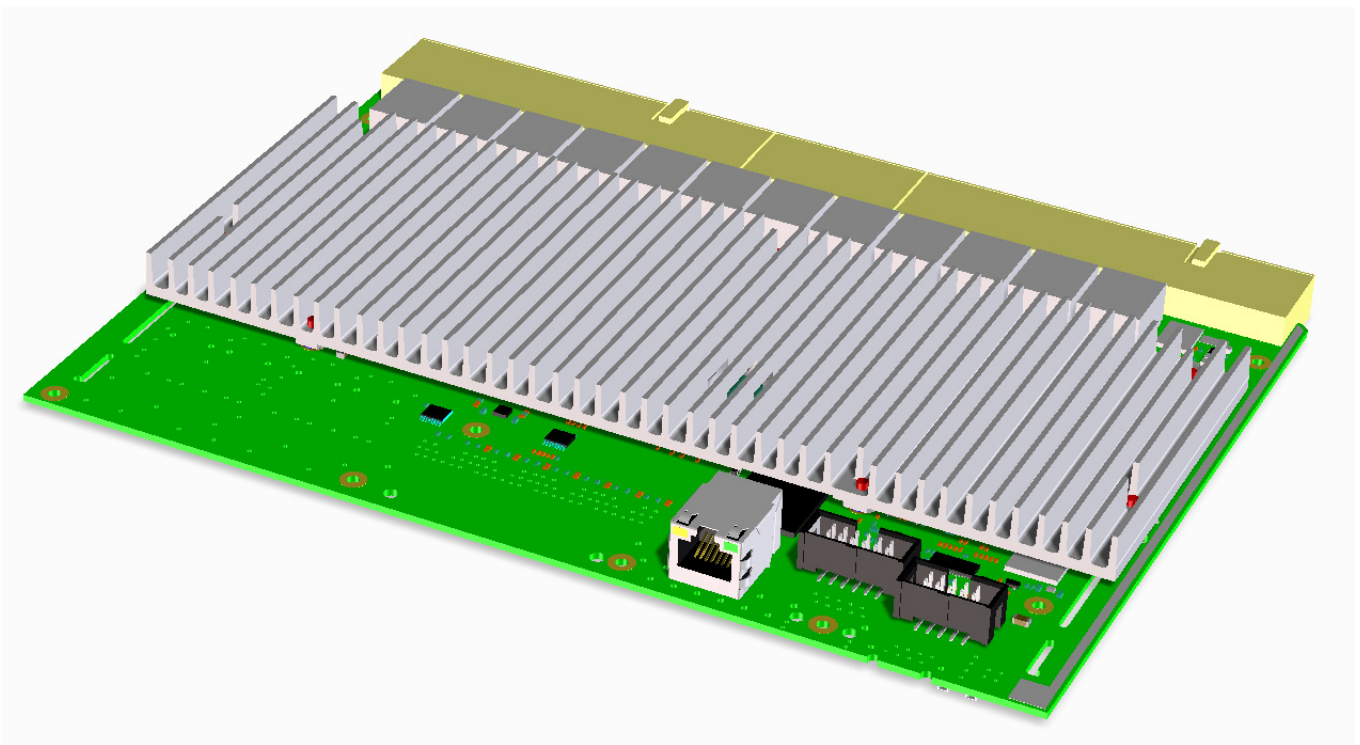

CP6924-RA-A

Document Revision 1.1

Date: November, 2015

Revision History

Publication Title: CP6924-RA-A		
Rev.	Brief Description of Changes	Date of Issue
1.0	Initial Issue	2015-11-18
1.1	Minor changes in all chapters	2015-11-27

Imprint

Kontron Europe GmbH may be contacted via the following:

MAILING ADDRESS

Kontron Europe GmbH
Lise-Meitner-Straße 3-5
D - 86156 Augsburg Germany

TELEPHONE AND E-MAIL

+49 (0) 800-SALESKONTRON
sales@kontron.com

For further information about other Kontron products, please visit our Internet web site: www.kontron.com.

Disclaimer

Copyright © 2015 Kontron AG. All rights reserved. All data is for information purposes only and not guaranteed for legal purposes. Information has been carefully checked and is believed to be accurate; however, no responsibility is assumed for inaccuracies. Kontron and the Kontron logo and all other trademarks or registered trademarks are the property of their respective owners and are recognized. Specifications are subject to change without notice.

Contents

Revision History	2
Imprint	2
Disclaimer	2
Proprietary Note	8
Trademarks	8
Environmental Protection Statement	8
Advisory Conventions	8
Safety Instructions	9
General Instructions on Usage	11
Two Year Warranty	11
1 Introduction	12
1.1 Product Overview	12
1.1.1 CP6924 Features	12
1.1.2 General compliances	13
1.2 Technical Specification	14
1.2.1 Power Requirements	14
1.2.2 Mechanics	14
1.2.3 Temperature	14
1.2.4 Humidity	14
1.2.5 Altitude	14
1.2.6 Vibration	14
1.2.7 Shock	14
1.2.8 Safety	15
1.2.9 Electromagnetic Compatibility	15
1.2.10 Reliability	15
1.2.11 WEEE	15
1.2.12 RoHS Compliance	15
1.2.13 Lead-free	15
1.3 Software Support	16
2 Installation	18
2.1 Safety Requirements	18
2.2 CP6924 Initial Installation Procedures	19
2.3 Standard Removal Procedures	20
2.4 Software Installation	20
2.5 Quick Start	21
2.5.1 Out-of-Band CLI Access	21
2.5.2 In-Band CLI Access	22

3	Functional Description	24
3.1	Ethernet Infrastructure	25
3.2	Unit Computer and Memory	26
3.3	IPMI	26
3.3.1	Voltage Sensors	27
3.3.2	Current sensors	27
3.4	Board Interfaces	28
3.4.1	Front Panel Management Port RJ45	28
3.4.2	CompactPCI Connectors	28
3.5	Write Protection Feature	33
4	Software Description	34
4.1	Supported RFCs	34
4.1.1	Management	34
4.1.2	Switching	35
4.1.3	Routing	37
4.1.4	QoS	38
4.1.5	Multicast	39
4.2	Supported MIBs	39
4.2.1	Enterprise MIB	39
4.2.2	Base Package MIBs	39
4.2.3	Switching Package MIBs	40
4.2.4	Routing Package MIBs	41
4.2.5	QoS Package MIBs	41
4.2.6	Multicast package MIBs	41
4.2.7	Security MIBs	42
4.2.8	Kontron Private MIBs	42
4.3	Bootloader	43
4.3.1	Power On Self Test	44
4.3.2	Bootloader Shell Options	45
4.3.3	Bootloader Pushbutton Reset	47
4.3.4	Bootloader Rollback Control	47
4.4	IPMI Firmware	48
4.4.1	Supported IPMI Commands	48
4.4.2	Board Sensors	54
4.4.3	Board FRU Information	64
4.5	Software Administration	65
4.5.1	Updating System Software	66
4.5.2	Updating IPMI Firmware	67

5	Thermal Considerations	68
6	Power Considerations	70
6.1	Baseboard	70
6.2	Backplanes	70

List of Tables

Table 1-1:	CP6924 Software Specification.....	16
Table 3-1:	Ethernet Port Mapping	25
Table 3-2:	Peripheral Manager AD Input and Voltage Assignment.....	27
Table 3-3:	Front RJ45 Ethernet Connector	28
Table 3-4:	Connector J1 Pinout	29
Table 3-5:	Connector J2 Pinout	30
Table 3-6:	Connector J3 Pinout	31
Table 3-7:	Connector J4 Pinout	32
Table 3-8:	Connector J5 Pinout	33
Table 4-1:	POST tests	44
Table 4-2:	POST routines and error codes	44
Table 4-3:	Bootloader Environment Variables.....	45
Table 4-4:	Standard Commands.....	48
Table 4-5:	HPM.1 Commands	50
Table 4-6:	Kontron OEM Commands.....	50
Table 4-7:	Sensor List.....	55
Table 4-8:	IPMB Link (Type C3h) Reading.....	57
Table 4-9:	IPMB Link (Type C3h) Event Message	58
Table 4-10:	MMC Reboot (Type 24h) Reading	59
Table 4-11:	MMC Reboot (Type 24h) Event Message.....	59
Table 4-12:	MMC FwUp (Type C7h) Reading.....	60
Table 4-13:	MMC FwUp (Type C7h) Event Message	60
Table 4-14:	POST Fail (Type 0Fh) Reading.....	61
Table 4-15:	POST Fail (Type 0Fh) Event Message	61
Table 4-16:	Boot Fail (Sensor Type 1Eh) Reading	62
Table 4-17:	Boot Fail (Sensor Type 1Eh) Event Message	62
Table 4-18:	Temperature Sensor Thresholds [°C]	63
Table 4-19:	Voltage Sensor Thresholds [V]	63
Table 4-20:	Current Sensor Thresholds [I]	63
Table 4-21:	On-board NOR FLASH Partition Scheme (128MB)	65
Table 6-1:	Maximum Input Power Voltage Limits.....	70

List of Figures

Figure 3-1: CP6924-RA-A Functional Block Diagram	24
Figure 5-1: Position of Temperature Sensors, Top Side View	68

Proprietary Note

This document contains information proprietary to Kontron. It may not be copied or transmitted by any means, disclosed to others, or stored in any retrieval system or media without the prior written consent of Kontron AG or one of its authorized agents.

The information contained in this document is, to the best of our knowledge, entirely correct. However, Kontron AG cannot accept liability for any inaccuracies or the consequences thereof, or for any liability arising from the use or application of any circuit, product, or example shown in this document.

Kontron AG reserves the right to change, modify, or improve this document or the product described herein, as seen fit by Kontron AG without further notice.

Trademarks







Kontron AG and the Kontron logo are trade marks owned by Kontron AG, Germany. In addition, this document may include names, company logos and trademarks, which are registered trademarks and, therefore, proprietary to their respective owners.

Environmental Protection Statement

This product has been manufactured to satisfy environmental protection requirements where possible. Many of the components used (structural parts, printed circuit boards, connectors, batteries, etc.) are capable of being recycled.

Final disposition of this product after its service life must be accomplished in accordance with applicable country, state, or local laws or regulations.

Advisory Conventions

CAUTION		
	This symbol and title indicate potential damage and tells you how to avoid the problem.	
Electric Shock		
	This symbol and title warn of hazards due to electrical shocks (> 60V) when touching products or parts of them. Failure to observe the precautions indicated and/or prescribed by the law may endanger your life/health and/or result in damage to your material.	
WARNING		
	This symbol and title emphasize points which, if not fully understood and taken into consideration by the reader, may endanger your health and/or result in damage to your material.	
ESD Sensitive Device		
	This symbol and title inform that electronic systems and their components are sensitive to static electricity. Therefore, care must be taken during all handling operations and inspections of this product, in order to ensure product integrity at all times. Please read also the section "Special Handling and Unpacking Instructions".	

**Note...**

This symbol and title emphasize aspects the reader should read through carefully for his or her own advantage.

**CE Conformity**

This symbol indicates that the product described in this manual is in compliance with all applied CE standards. Please refer also to the section „Regulatory compliance Statements“ in this manual.

Safety Instructions

Your new Kontron product was developed and tested carefully to provide all features necessary to ensure its compliance with electrical safety requirements. It was also designed for a long fault-free life. However, the life expectancy of your product can be drastically reduced by improper treatment during unpacking and installation. Therefore, in the interest of your own safety and of the correct operation of your new Kontron product, you are requested to conform with the following guidelines.

Temperature and High Voltage Safety Instructions

WARNING



All operations on this device must be carried out by sufficiently skilled personnel only.

Be careful, this device will heat up during operation, and if touched may cause burns. The temperature of the product housing may reach up to approximately 50°C. Allow for sufficient cool down before handling after power is turned off.

**Electric Shock**

Before installing your new Kontron product into a system always ensure that your mains power is switched off. This applies also to the installation of piggybacks.

Serious electrical shock hazards can exist during all installation, repair and maintenance operations with this product. Therefore, always unplug the power cable and any other cables which provide external voltages before performing work.



Laser Lights



Laser light from fiber-optic transmission cables and components can damage your eyes. The laser components plugged into the switch are Class 1 laser components. Class 1 laser is considered incapable of producing damaging radiation levels during normal operation or maintenance.



To avoid damaging your eyes and to continue safe operation in case of abnormal circumstances:

- Never look directly into the outlets of fiber-optic transmission components or fiber-optic cables with unprotected eyes.
 - Never allow fiber-optic transmission path to operate until all the connections have been made.
 - Always fit protective plugs to any unused ports of the switch.
-

Special Handling and Unpacking Instructions

ESD Sensitive Device



Electronic systems and their components are sensitive to static electricity. Therefore, care must be taken during all handling operations and inspections of this product, in order to ensure product integrity at all times.

Do not handle this product out of its protective enclosure while it is not used for operational purposes unless it is otherwise protected.

Whenever possible, unpack or pack this product only at EOS/ESD safe work stations. Where a safe work station is not guaranteed, it is important for the user to be electrically discharged before touching the product with his/her hands or tools. This is most easily done by touching a metal part of your system housing.

It is particularly important to observe standard anti-static precautions when changing piggybacks, ROM devices, jumper settings etc. If the product contains batteries for RTC or memory back-up, ensure that the system is not placed on conductive surfaces, including anti-static plastics or sponges. They can cause short circuits and damage the batteries or conductive circuits on the system.

General Instructions on Usage

In order to maintain Kontron's product warranty, this product must not be altered or modified in any way. Changes or modifications to the device, which are not explicitly approved by Kontron AG and described in this manual or received from Kontron's Technical Support as a special handling instruction, will void your warranty.

This device should only be installed in or connected to systems that fulfill all necessary technical and specific environmental requirements. This applies also to the operational temperature range of the specific system version, which must not be exceeded. If batteries are present their temperature restrictions must be taken into account.

In performing all necessary installation and application operations, please follow only the instructions supplied by the present manual.

Keep all the original packaging material for future storage or warranty shipments. If it is necessary to store or ship the system, please re-pack it as nearly as possible in the manner in which it was delivered.

Special care is necessary when handling or unpacking the product. Please consult the special handling and unpacking instruction on the previous page of this manual.

Two Year Warranty

Kontron grants the original purchaser of Kontron's products a TWO YEAR LIMITED HARDWARE WARRANTY as described in the following. However, no other warranties that may be granted or implied by anyone on behalf of Kontron are valid unless the consumer has the express written consent of Kontron.

Kontron warrants their own products, excluding software, to be free from manufacturing and material defects for a period of 24 consecutive months from the date of purchase. This warranty is not transferable nor extendible to cover any other users or long-term storage of the product. It does not cover products which have been modified, altered or repaired by any other party than Kontron or their authorized agents. Furthermore, any product which has been, or is suspected of being damaged as a result of negligence, improper use, incorrect handling, servicing or maintenance, or which has been damaged as a result of excessive current/voltage or temperature, or which has had its serial number(s), any other markings or parts thereof altered, defaced or removed will also be excluded from this warranty.

If the customer's eligibility for warranty has not been voided, in the event of any claim, he may return the product at the earliest possible convenience to the original place of purchase, together with a copy of the original document of purchase, a full description of the application the product is used on and a description of the defect. Pack the product in such a way as to ensure safe transportation (see our safety instructions).

Kontron provides for repair or replacement of any part, assembly or sub-assembly at their own discretion, or to refund the original cost of purchase, if appropriate. In the event of repair, refunding or replacement of any part, the ownership of the removed or replaced parts reverts to Kontron, and the remaining part of the original guarantee, or any new guarantee to cover the repaired or replaced items, will be transferred to cover the new or repaired items. Any extensions to the original guarantee are considered gestures of goodwill, and will be defined in the "Repair Report" issued by Kontron with the repaired or replaced item.

Kontron will not accept liability for any further claims resulting directly or indirectly from any warranty claim, other than the above specified repair, replacement or refunding. In particular, all claims for damage to any system or process in which the product was employed, or any loss incurred as a result of the product not functioning at any given time, are excluded. The extent of Kontron liability to the customer shall not exceed the original purchase price of the item for which the claim exists.

Kontron issues no warranty or representation, either explicit or implicit, with respect to its products' reliability, fitness, quality, marketability or ability to fulfil any particular application or purpose. As a result, the products are sold "as is," and the responsibility to ensure their suitability for any given task remains that of the purchaser. In no event will Kontron be liable for direct, indirect or consequential damages resulting from the use of our hardware or software products, or documentation, even if Kontron were advised of the possibility of such claims prior to the purchase of the product or during any period since the date of its purchase.

Please remember that no Kontron employee, dealer or agent is authorized to make any modification or addition to the above specified terms, either verbally or in any other form, written or electronically transmitted, without the company's consent.

1 Introduction

1.1 Product Overview

The Kontron CP6924-RA-A is a Standard Fabric 6U CompactPCI Gigabit Ethernet Switch with 24 channels and is a PICMG 2.16 compliant. It provides 24 links to the backplane (one fabric board, 19 node boards and four extended node boards). As the board is designed to fit into a custom chassis, there is no front plate.

The CP6924-RA-A is specifically designed for applications in airborne environments. It fulfills the RTCA DO160 requirements including operation in the extended temperature range of -40 to +85°C and conformal coating for moisture contaminant and corrosion protection.

1.1.1 CP6924 Features

The board is composed of the following building blocks:

- Ethernet Infrastructure
- Unit Computer and Memory
- IPMI
- Power Supply

1.1.1.1 Ethernet Infrastructure

- Broadcom StrataXGS®IV Metro Ethernet Access Switch Architecture
- BCM56334 with 24x 1GbE Ports (SGMII) and 4x 10GbE (XAUI)
- Unit Computer manages Switch via PCIe Gen1 x1 (2.5Gbps)
- 3x Broadcom BCM54680 10/100/1000Base-T Transceiver with SGMII Ports
- 24x 10/100/1000Base-T via MII interface to backplane connector J5, J4 and J3
- BCM56334 Switch manages transceiver via MIIM0 Interface
- LED BUS connects to CPLD
- Switch supports JTAG Boundary Scan

1.1.1.2 Unit Computer and System Memory

- Socketless PowerPC: IBM PPC405Ex 600 MHz
- Used for switch provisioning and diagnostics
- 512 MBytes DDR2 RAM 200 MHz
- 128 MBytes NOR Flash
- PCIe Management interface to BCM5633x
- 10/100/1000Base-T Management Port via Copper PHY BCM54610 connected to FP RJ45
- 2x UART connects to CPLD
- Configuration EEPROM
- I2C Interface and SPI Interface to CPLD
- NVRAM write protection
- PPC405EX supports JTAG Boundary Scan

1.1.1.3 IPMI

- NXP LPC2368 32-Bit Microcontroller
- PICMG 2.9 / IPMI 1.5 compliant
- Dual Image Support
- 2 MByte Flash (Boot Image)
- 64 kByte EEPROM (FRU)
- Board Voltage and current monitoring
- Board Temperature monitoring via I²C enabled sensors
- Switchable pull ups at IPMB0/1 backplane signals

1.1.1.4 Power Supply

- 5V and 3.3V only board, no 12V or -12V required
- IPMB_PWR used for 3.3V PM (generated by LDO)
- Hot Swap support
- 3V3 V stabilization
- Point of Load Converters for chip core voltages

1.1.1.5 Miscellaneous

- JTAG Boundary Scan support
- Board layout is prepared for conduction cooling
- All parts are extended temperature range parts: -40°C to +85°C or better

1.1.2 General compliances

The Board is compatible to the following standards:

- PICMG® 2.0 R3.0 CompactPCI® Specification, as amended by ERN 2.0-3.0-002
- PICMG® 2.1 R2.0 CompactPCI® Hot Swap Specification
- PICMG® 2.9 R1.0 CompactPCI® System Management Specification
- PICMG® 2.16 R1.0 Sep. 5, 2005 Packet Switching Backplane Specification
- Intelligent Platform Management Interface Specification V1.5
- IEEE 802.3, 2008 section 3
- IEEE 802.3 2008 section 4 Clause 47 XGMII Extender Sublayer (XGXS) and 10 Gigabit Attachment Unit Interface (XAUI)

1.2 Technical Specification

1.2.1 Power Requirements

Operating voltages are 5.0 Volt and 3.3 Volt.

The maximum power consumption is less than 50W.

1.2.2 Mechanics

Compliant to PICMG® 2.0 6U/4HP (233.35 mm x 160 mm).

- Weight: 568g

1.2.3 Temperature

Compliant to IEC 60068-2-1 and IEC 60068-2-2.

- Operation from -40° C to +85° C inlet air temperature

Required average inlet airflow should be around 400LFM (2 m/s) for the maximum cooling. Other thermal limitations may apply and are the responsibility of the system integrator.

Storage temperature range is -50° C to +105° C.

1.2.4 Humidity

The boards are designed to meet the standard IEC 60068-2-78 operating 93% at 40° C (non-condensing).

1.2.5 Altitude

The boards are designed to meet the following requirements:

- Operating: 4000m (13123 ft). Check for onboard peripherals if applicable
- Non-Operating: 15000 m (49212 ft)

1.2.6 Vibration

The CP6924-RA-A board is designed to meet the requirements according EN60068-2-6:

- 10 Hz to 300 Hz, 2g acceleration
- 1 octave/min
- 10 cycles/axis, 3 directions [x, y, z]



Note...

If the CP6924-RA-A board is used in heavy shock and vibration environment, the hole system must withstand these requirements. This means the chassis, backplane and guide-rails should be designed for harsh environment. Guide rails with wedge locks are recommend. The backplane has to be stiffened to avoid connector micro movement. It is also recommended to use connectors which are designed for a rugged environment.

1.2.7 Shock

The CP6924-RA-A board is designed to meet the VITA 47 standard:

- Peak Acceleration: 20 g, Shock Duration: 11 ms, Recovery Time: 5 s, Shock Count: 3/direction, 6 directions

1.2.8 Safety

The boards are designed to meet or meets the following requirements:

- UL 60950-1, 2nd Edition (US and Canada)
- EN 60950-1, (Europe)

The boards are designed to meet the following flammability requirement (as specified in Telcordia GR-63-CORE):

- UL 94V-0/1 with Oxygen index of 28% or greater material

1.2.9 Electromagnetic Compatibility

The boards are designed to meet or exceed class B limit of the following specifications/requirements (assuming an adequate system/chassis):

- FCC 47 CFR Part 15, Subpart B (USA)
- EN55022 (Europe)
- EN55024 (Europe)
- EN61000-6-3 (Europe)
- EN61000-6-2 (Europe)
- VCCI (Voluntary Japan Electromagnetic Compatibility requirement)
- EN 300 386, Electro-Magnetic Compatibility (EMC) Requirements for Public Telecommunication Network Equipment; Electromagnetic Compatibility (EMC) Requirements

1.2.10 Reliability

Targeted MTBF is around 140.000h @ 30° C, calculations based on Bellcore Issue 6.

1.2.11 WEEE

Compliant to:

- Directive 2002/96/EC: Waste electrical and electronic equipment

1.2.12 RoHS Compliance

Components and materials of the product must not contain lead, mercury, cadmium, hexavalent chromium, polybrominated biphenyls (PBB) or polybrominated diphenyl ethers (PBDE) according Directive 2011/65/EU.

1.2.13 Lead-free

The boards have to be completely lead-free concerning the production process and the components used.

1.3 Software Support

The following table contains information related to software supported by the CP6924.

Table 1-1: CP6924 Software Specification

CP6924	SPECIFICATIONS
General	<ul style="list-style-type: none"> • Reliable field upgrades for all software components • Dual boot images with roll-back capability • Management via SNMP and Command Line Interface • System access via TELNET, SSH and serial line • Hot-Swap support (IPMI)
Ethernet/Bridging	<ul style="list-style-type: none"> • Static link aggregation (IEEE 802.3ad) • Classic and rapid spanning tree algorithms(IEEE 802.1D, IEEE 802.1w) • Multiple Spanning Tree (IEEE 802.S) • Quality Of Service on all ports (IEEE 802.1p) • Full Duplex operation and flow control on all ports (IEEE 802.3x) • Static MAC filtering • Port Authentication (IEEE 802.1X) • Auto negotiation of speeds and operational mode on all external copper GE interfaces as well as on all base fabric interfaces • Layer 2 multicast services using GARP/GMRP (IEEE 802.1p) • VLAN support including VLAN tagging (IEEE 802.3ac), dynamic VLAN registration with GARP/GVRP (IEEE 802.1Q) and Protocol based VLANs (IEEE 802.1v) • Double VLAN tagging • Port Mirroring
IP Routing	<ul style="list-style-type: none"> • Redundancy of routing functionality using a second switch hub board • IPv4 Forwarding on all base channels and connected uplink ports • Quality of service according to the DiffServ standards • ARP for all routable interfaces • ICMP for all routable interfaces • OSPF routing protocol version 2 • RIP routing protocol version 2 • VRRP (virtual router redundancy protocol) for transparent fail over of default routers • IGMP snooping
QoS	<ul style="list-style-type: none"> • CoS (Class of Service) • DiffServ (Differentiated Services) • ACL (Access Control List)
IP Multicast	<ul style="list-style-type: none"> • DVMRP • PIM-DM • PIM-SM • IGMP (Internet Group Message Protocol) v2 and v3 • IGMP Proxy

Table 1-1: CP6924 Software Specification (Continued)

CP6924	SPECIFICATIONS
Applications	<ul style="list-style-type: none"> • SNMP client for retrieving accurate time and date information • DHCP server • Onboard event management • Test and trace facilities • POST (power on self tests) diagnostics • Standards based SNMP implementation supporting SNMP v1, v2 and v3 for monitoring and management purposes • Persistent storage of configuration across restarts • Support for retrieving and installing multiple configurations • Support for startup configurations based on the cPCI SGA/GA (Shelf Geographical Address/Geographical Address), see CP6924 CLI Reference Manual, chapter „AutoInstall Commands“
Supported MIBS	<ul style="list-style-type: none"> • For a list of supported MIBs, see chapter “Supported MIBs” on page 39
Bootloader	<ul style="list-style-type: none"> • u-boot Version 1.3.4 • POST • multi image support • reliable field upgradable • H/W protected • KCS interface to PM • serial console support
Operating System	<ul style="list-style-type: none"> • Windriver PNE 4.3

2 Installation

The CP6924 has been designed for easy installation. However, the following standard precautions, installation procedures, and general information must be observed to ensure proper installation and to preclude damage to the board, other system components, or injury to personnel.

2.1 Safety Requirements

The following safety precautions must be observed when installing or operating the CP6924. Kontron assumes no responsibility for any damage resulting from failure to comply with these requirements.

WARNING



Due care should be exercised when handling the board due to the fact that the heat sink can get very hot. Do not touch the heat sink when installing or removing the board.



In addition, the board should not be placed on any surface or in any form of storage container until such time as the board and heat sink have cooled down to room temperature.

WARNING



Be careful when inserting or removing the CP6924. The SFP cages have sharp edges which might lead to injuries.



ESD Sensitive Device



The CP6924 board contains electrostatically sensitive devices. Please observe the necessary precautions to avoid damage to your board:

- Discharge your clothing before touching the assembly. Tools must be discharged before use.
 - When unpacking a static-sensitive component from its shipping carton, do not remove the component's antistatic packing material until you are ready to install the component in a computer. Just before unwrapping the antistatic packaging, be sure you are at an ESD workstation or grounded. This will discharge any static electricity that may have built up in your body.
 - When transporting a sensitive component, first place it in an antistatic container or packaging.
 - Handle all sensitive components at an ESD workstation. If possible, use antistatic floor pads and workbench pads.
 - Handle components and boards with care. Don't touch the components or contacts on a board. Hold a board by its edges or by its metal mounting bracket.
 - Do not handle or store system boards near strong electrostatic, electromagnetic, magnetic, or radioactive fields.
-

2.2 CP6924 Initial Installation Procedures

The following procedures are applicable only for the initial installation of the CP6924 in a system. Procedures for standard removal and hot swap operations are found in their respective chapters.

To perform an initial installation of the CP6924 in a system proceed as follows:

1. Ensure that the safety requirements indicated in chapter Safety Requirements are observed.

WARNING



Failure to comply with the instruction below may cause damage to the board or result in improper system operation.



-
2. Ensure that the board is properly configured for operation in accordance with application requirements before installing. For information regarding the configuration of the CP6924 refer to the CLI Reference Manual.

WARNING



Care must be taken when applying the procedures below to ensure that neither the CP6924 nor other system boards are physically damaged by the application of these procedures.



-
3. To install the CP6924-RA-A refer to the system manual.
 4. The CP6924 is now ready for operation.

2.3 Standard Removal Procedures

To remove the board proceed as follows:

1. Ensure that the safety requirements indicated in chapter Safety Requirements are observed.

WARNING



Care must be taken when applying the procedures below to ensure that neither the CP6924 nor other system boards are physically damaged by the application of these procedures.



-
2. Ensure that no power is applied to the system before proceeding.
 3. Disconnect any interfacing cables that may be connected to the board.
 4. For removing the board from the system, refer to the system manual.

2.4 Software Installation

The CP6924 comes as a pre-installed system with all necessary OS, filesystem, drivers and applications factory-installed with default configurations.

Updating the Software with new operating system or applications or new versions is provided by a dedicated update mechanism, which is described in Chapter 4.

2.5 Quick Start

This section gives instructions for (initially) accessing the CLI (Command Line Interface) of the CP6924 using either in-band access via the ethernet fabric or the out-of-band management interfaces (serial port or Gigabit Ethernet) accessible from the front plate serial connector or via an appropriate RIO module. The CLI is required for configuring the GbE switch.

2.5.1 Out-of-Band CLI Access

The CLI can be accessed via serial port (using the front plate connector and provided adapter or an appropriate RIO module) or Gigabit Ethernet (via the front plate RJ45 connector).

2.5.1.1 Serial Port

The serial port is ready to use offhand without further configuration.

Port settings are:

- 115200 bps (serial speed might be different for customized board variants)
- 8 bit, no parity, 1 stop bit (8N1)
- no flow control

2.5.1.2 Gigabit Ethernet Serviceport

The Gigabit Ethernet serviceport on the CP6924 front plate has no IP address set by default, it is necessary to assign an IP address statically or enable dhcp on the serviceport. Because the required configuration steps are done in the CLI, an initial access using the serial port is required.

The procedure for assigning an IP address to the serviceport is described in the following. User input is printed in bold letters.

1. Connect to serial port on the front plate (using the Kontron DB9 adapter cable) or RIO module (using a RJ45 straight cable).
2. Ensure that the board is powered up.
3. Log in as **admin** and enter privileged mode by typing '**enable**' (no passwords required by default).

```
User: admin
Password:
(Ethernet Fabric) >enable
Password:
```

```
(Ethernet Fabric) #
```

4. Set IP address and netmask. (see below for an example IP address setting)

```
(Ethernet Fabric) #serviceport ip 192.168.50.107 255.255.255.0
```

The GbE management interface is available from now on.

Alternatively, DHCP can be set for the serviceport

```
(Ethernet Fabric) #serviceport protocol dhcp
```

An IP address will be assigned to the serviceport by a DHCP server.

5. Save configuration using the '**write mem**' command and confirm with 'y'

```
(Ethernet Fabric) #write mem

This operation may take a few minutes.
Management interfaces will not be available during this time.

Are you sure you want to save? (y/n) y

Config file 'current/startup-config' created successfully.

Configuration Saved!

(Ethernet Fabric) #
```

To access the CLI via Gigabit Ethernet serviceport, open a telnet connection to the configured IP address, port 23.

2.5.2 In-Band CLI Access

The GbE switch network port (in-band management access) on the CP6924 has no IP address set by default, it is necessary to assign an IP address either statically or by using DHCP to the network port. Because the required configuration steps are done in the CLI, an initial access using the serial port is required.

The procedure for assigning an IP address to the network port is described in the following. User input is printed in bold letters.

6. Connect to serial port on the front plate (using the Kontron DB9 adapter cable) or RIO module (using a RJ45 straight cable).
7. Ensure that the board is powered up.
8. Log in as **admin** and enter privileged mode by typing '**enable**' (no passwords required by default).

```
User:admin
Password:
(Ethernet Fabric) >enable
Password:

(Ethernet Fabric) #
```

9. Set IP address, netmask and default gateway. (see below for an example IP address setting)

```
(Ethernet Fabric) #network parms 192.168.50.107 255.255.255.0 192.168.50.254
```

The GbE management interface is available from now on.

Alternatively, DHCP can be set for the network port

```
(Ethernet Fabric) #network protocol dhcp
```

An IP address will be given to the network port by a DHCP server.

10. Save configuration by using the **'write mem'** command and confirm **'y'**

```
(Ethernet Fabric) #write mem
```

```
This operation may take a few minutes.  
Management interfaces will not be available during this time.
```

```
Are you sure you want to save? (y/n) y
```

```
Config file 'current/startup-config' created successfully.
```

```
Configuration Saved!
```

```
(Ethernet Fabric) #
```

To access the CLI via Gigabit Ethernet networkport, open a telnet connection to the configured IP address, port 23.
It might make sense to separate the management network from the data path by setting appropriate VLANs
For additional information on the system configuration, refer to the CP6924 CLI Reference Manual.

3 Functional Description

This chapter describes the board specific items of the CP6924-RA-A. The base board is a standard Fabric 6U CompactPCI Gigabit Ethernet Switch with 24 channels.

Figure 3-1: CP6924-RA-A Functional Block Diagram

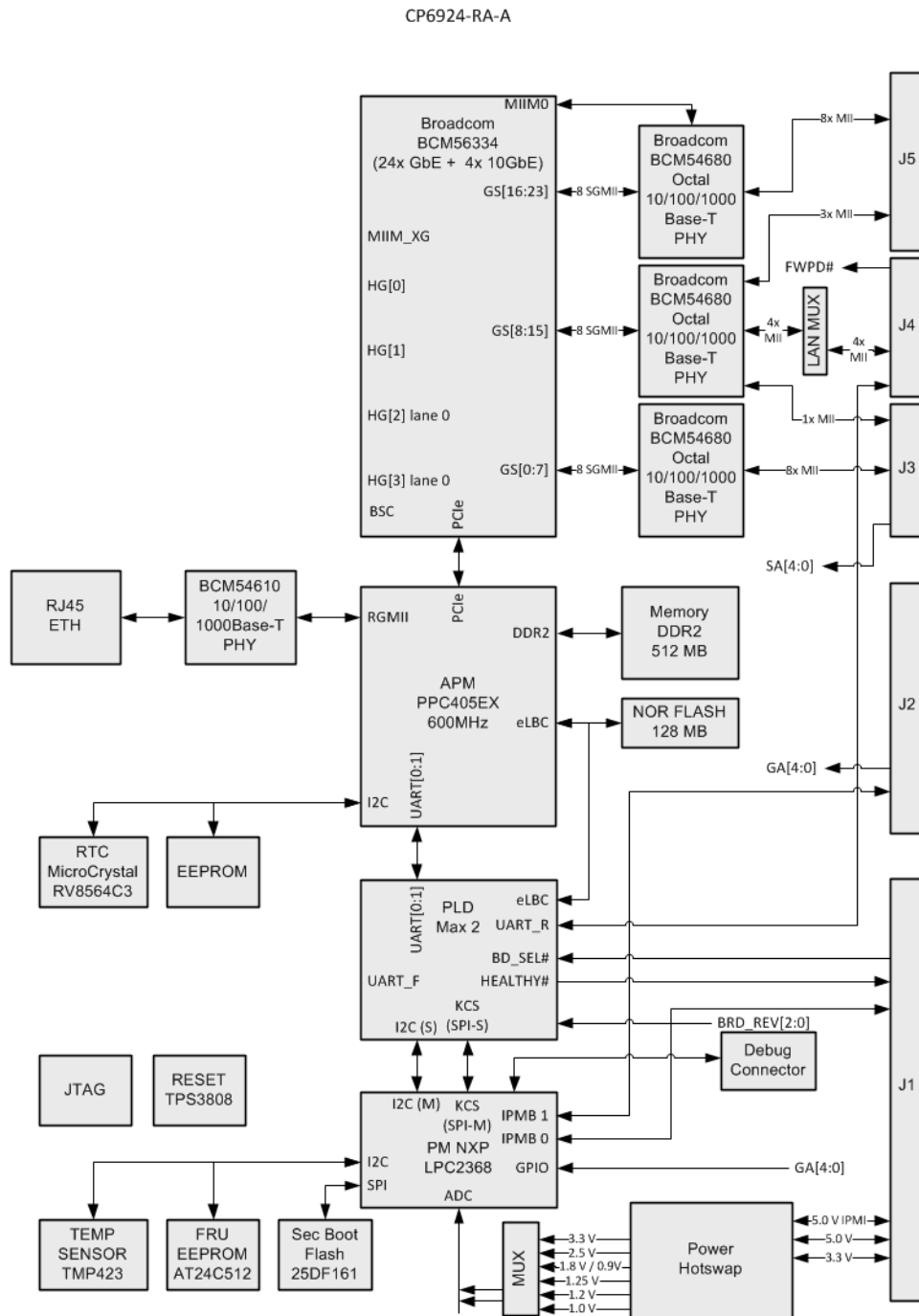

The board is composed of the following building blocks:

- Ethernet Infrastructure
- Unit Computer and Memory
- IPMI
- Power Supply

3.1 Ethernet Infrastructure

The fabric switch infrastructure is composed of

- Broadcom StrataXGS®IV Chip BCM56334 with 24x 1GbE Ports (SGMII) and 4x 10GbE (XAUI)
- Three Broadcom BCM54680 10/100/1000Base-T Transceiver with SGMII Ports
- 24x 10/100/1000Base-T via MII interface to backplane connector J5, J4 and J3
- BCM56334 Switch manages transceiver via MIIM0 Interface and MIIM_XG interface
- Broadcom BCM8727 Dual-Channel 10 GbE SFI-to-XAUI™ Transceiver with EDC
- BSC Master I2C for SFP support
- SPI FLASH programming interface
- LED BUS connects to CPLD
- Switch supports JTAG Boundary Scan

The ports of the switch are mapped as shown in the following table.

Table 3-1: Ethernet Port Mapping

CLI	Interface	Speed Settings
0/1	FL 1	10/100/1000 Mbps
0/2	FL 2	10/100/1000 Mbps
0/3	FL 3	10/100/1000 Mbps
0/4	FL 4	10/100/1000 Mbps
0/5	FL 5	10/100/1000 Mbps
0/6	FL 6	10/100/1000 Mbps
0/7	FL 7	10/100/1000 Mbps
0/8	FL 8	10/100/1000 Mbps
0/9	FL 9	10/100/1000 Mbps
0/10	FL 10	10/100/1000 Mbps
0/11	FL 11	10/100/1000 Mbps
0/12	FL 12	10/100/1000 Mbps
0/13	FL 13	10/100/1000 Mbps
0/14	FL 14	10/100/1000 Mbps
0/15	FL 15	10/100/1000 Mbps
0/16	FL 16	10/100/1000 Mbps
0/17	FL 17	10/100/1000 Mbps
0/18	FL 18	10/100/1000 Mbps
0/19	FL 19	10/100/1000 Mbps
0/20	FL 20	10/100/1000 Mbps

Table 3-1: Ethernet Port Mapping (Continued)

CLI	Interface	Speed Settings
0/21	FL 21	10/100/1000 Mbps
0/22	FL 22	10/100/1000 Mbps
0/23	FL 23	10/100/1000 Mbps
0/24	FL 24	10/100/1000 Mbps

3.2 Unit Computer and Memory

The Unit Computer controls the Ethernet infrastructure and hosts the management application. It is a PowerPC 405EX with following features:

- 600MHz core frequency
- PCIe management connection to Ethernet Switch
- GbE connections to front management port and Ethernet Switch

The Unit Computer is equipped with following peripherals:

- 512 MBytes DDR2 RAM 200 MHz
- 128 MBytes NOR Flash Memory for two Firmware images
- RTC Clock

3.3 IPMI

The CP6924 board supports an intelligent hardware management system, based on the Intelligent Platform Management Interface Specification 1.5. The hardware management system provides the ability to manage the power, cooling and inter-connect needs of intelligent devices, to monitor events and to log events to a central repository intelligent FRU (Field Replaceable Unit).

The Peripheral Manager is a 32-bit microcontroller with on chip memory of 2 Mbyte Flash and 64 Kbyte EEPROM. It provides several I²C interfaces for access to sensors and IPMB busses. Board voltage, current and temperature monitoring are accomplished through internal and external sensors.

The following section provides a listing of all inputs to the IPMI subsystem for H/W supervision.

- Thermal, current and voltage Sensors
- Reset status of the Unit Computer
- Power Status, the PM reads all supply voltages and status signals for possible failure and value reporting
- SFP status and control signals
- CompactPCI Handle switch (not on CP6924-RC and CP6924-A)

The PM uses the following outputs to control the CP6924:

- Power and Reset control of the payload
- IMPB A and IMPB B support
- LED HEALTHY (not on CP6924-RC)
- Unit Computer reset

The Peripheral Manager provides additional feature and is equipped with following peripherals:

- The FRU Data Flash device contains the CP6924 FRU information
- Internal watchdog monitoring PM operation
- The external watchdog is implemented in glue logic. The PM will be reset if its alive signal fails. The watchdog is disabled in case of a local update.
- CompactPCI IPMB-0 interface

3.3.1 Voltage Sensors

The Peripheral Manager has 6 AD converters. Two analog multiplexer are used to measure all voltages on the CP6924. The following table shows the settings of the multiplexer control signals.

Table 3-2: Peripheral Manager AD Input and Voltage Assignment

Signal	PM_AD1_SEL	PM_AD2_SEL	Nominal Voltage	PM AD PIN	Voltage divider Factor	Amplifier Gain
MUX_V_0V9_VTT	0	0	0.9V	AD0_0	2.6	6.11
MUX_V_1V0	0	1	1.0V	AD0_0	2.6	6.11
MUX_V_1V2	0	0	1.2V	AD0_1	2.353	4.32
MUX_V_1V25	0	1	1.25V	AD0_1	2.353	4.32
MUX_V_1V8	1	X	1.8V	AD0_0	1	1(no amp)
MUX_V_2V5	1	X	2.5V	AD0_1	1.231	1(no amp)
MUX_V_3V3	1	X	3.3V	AD0_2	1.634	1(no amp)
MUX_V_3V3_SUS	0	1	3.3V	AD0_2	1.634	1(no amp)
MUX_V_3V3_CPLD	0	0	3.3V	AD0_2	1.634	1(no amp)
MUX_V_3V3_CPCI	0	0	3.3V	AD0_3	1.634	1(no amp)
MUX_V_5V_CPCI	0	0	5V	AD0_3	2.434	1(no amp)
MUX_V_5V_IPMB_PWR	1	X	5V	AD0_3	2.434	1(no amp)

3.3.2 Current sensors

The current of the backplane voltages can be measured by the Peripheral Manager internal A/D converters AD0_4 and AD0_5. The current is measured indirectly by the voltage drop of the sense resistor. The voltage drop is amplified with a fixed gain of 50.

$$I = U_{ADC} / (R * 50)$$

V_5V_CPCI_CURRENT is connected to AD0_4

V_3V3_CPCI_CURRENT is connected to AD0_5

3.4 Board Interfaces

3.4.1 Front Panel Management Port RJ45

The standard RJ45 has the following Pin Assignment.

Table 3-3: Front RJ45 Ethernet Connector

Contact	MDI	Contact	MDI	Contact	MDI	Contact	MDI
1.1	BI_DA+	2.1	BI_DA+	3.1	BI_DA+	4.1	BI_DA+
1.2	BI_DA-	2.2	BI_DA-	3.2	BI_DA-	4.2	BI_DA-
1.3	BI_DB+	2.3	BI_DB+	3.3	BI_DB+	4.3	BI_DB+
1.4	BI_DC+	2.4	BI_DC+	3.4	BI_DC+	4.4	BI_DC+
1.5	BI_DC-	2.5	BI_DC-	3.5	BI_DC-	4.5	BI_DC-
1.6	BI_DB-	2.6	BI_DB-	3.6	BI_DB-	4.6	BI_DB-
1.7	BI_DD+	2.7	BI_DD+	3.7	BI_DD+	4.7	BI_DD+
1.8	BI_DD-	2.8	BI_DD-	3.8	BI_DD-	4.8	BI_DD-

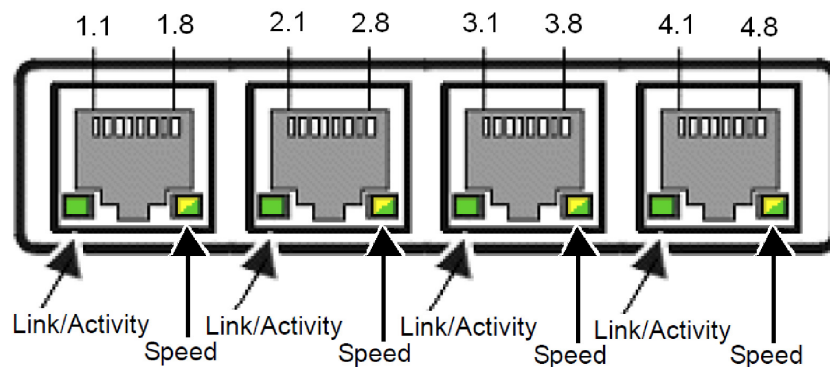

3.4.2 CompactPCI Connectors

The complete CompactPCI connector configuration comprises five connectors named J1 to J5. Their functions are as follows:

- J1, J2: management, IPMB and power, PCI is not supported
- J3, J4 and J5 have rear I/O interface functionality, providing GbE to the backplane or RIO module and an RS232 interface to a RIO module

The board supports signaling voltages V(I/O) of either 3.3 V or 5 V. No keying is required on J1 which designates universal V(I/O).

The CP6924 is compatible with all standard 6U CompactPCI passive backplanes with rear I/O support on the system slot. For accessing the GbE interfaces signals on connectors J3, J4 and J5 with a rear I/O module, a backplane with I/O support is necessary.

3.4.2.1 J1 Connector

- Power +3.3V, +5.0V, V(I/O)
- IPMB Power (+5.0V)
- IPMB 0
- Hot Swap

Table 3-4: Connector J1 Pinout

Pin	Row A	Row B	Row C	Row D	Row E	Row F
25	V_5V_CPCI	NC	NC	V_3V3_CPCI	V_5V_CPCI	GND
24	NC	V_5V_CPCI	V_IO_CPCI	NC	NC	GND
23	V_3V3_CPCI	NC	NC	V_5V_CPCI	NC	GND
22	NC	GND	V_3V3_CPCI	NC	NC	GND
21	V_3V3_CPCI	NC	NC	NC	NC	GND
20	NC	GND	V_IO_CPCI	NC	NC	GND
19	V_3V3_CPCI	NC	NC	GND	NC	GND
18	NC	GND	V_3V3_CPCI	NC	NC	GND
17	V_3V3_CPCI	IPMB0_SCL	IPMB0_SDA	GND	NC	GND
16	NC	GND	V_IO_CPCI	NC	NC	GND
15	V_3V3_CPCI	NC	NC	CPCI_BD_SEL#	NC	GND
14	Key Area					
13						
12						
11	NC	NC	NC	GND	NC	GND
10	NC	GND	V_3V3_CPCI	NC	NC	GND
9	NC	NC	NC	GND	NC	GND
8	NC	GND	V_IO_CPCI	NC	NC	GND
7	NC	NC	NC	GND	NC	GND
6	NC	NC	V_3V3_CPCI	NC	NC	GND
5	NC	NC	CPCI_PCI_RST#	GND	NC	GND
4	V_5V_IPMB_PWR	CPCI_HEALTHY#	V_IO_CPCI	NC	NC	GND
3	NC	NC	NC	V_5V_CPCI	NC	GND
2	NC	V_5V_CPCI	NC	NC	NC	GND
1	V_5V_CPCI	NC	NC	NC	V_5V_CPCI	GND

3.4.2.2 J2 Connector

- Geographical Address
- IPMB 1
- ALERT#

Table 3-5: Connector J2 Pinout

Pin	Row A	Row B	Row C	Row D	Row E	Row F
22	CPCI_GA[4]	CPCI_GA[3]	CPCI_GA[2]	CPCI_GA[1]	CPCI_GA[0]	GND
21	NC	NC	NC	NC	NC	GND
20	NC	NC	NC	NC	NC	GND
19	NC	NC	IPMB1_SDA	IPMB1_SCL	IPMB_ALERT#	GND
18	NC	NC	NC	NC	NC	GND
17	NC	NC	NC	NC	NC	GND
16	NC	NC	NC	NC	NC	GND
15	NC	NC	NC	NC	NC	GND
14	NC	NC	NC	NC	NC	GND
13	NC	NC	NC	NC	NC	GND
12	NC	NC	NC	NC	NC	GND
11	NC	NC	NC	NC	NC	GND
10	NC	NC	NC	NC	NC	GND
9	NC	NC	NC	NC	NC	GND
8	NC	NC	NC	NC	NC	GND
7	NC	NC	NC	NC	NC	GND
6	NC	NC	NC	NC	NC	GND
5	NC	NC	NC	NC	NC	GND
4	NC	NC	NC	NC	NC	GND
3	NC	NC	NC	NC	NC	GND
2	NC	NC	NC	NC	NC	GND
1	NC	NC	NC	NC	NC	GND

3.4.2.3 J3 Connector

- Link Port 1 to Link Port 8 (10/100/1000Base-T)
- Link Port f
- Shelf Geographical Address

Table 3-6: Connector J3 Pinout

Pin	Row A	Row B	Row C	Row D	Row E	Row F
19	CPCI_SA[4]	CPCI_SA[3]	CPCI_SA[2]	CPCI_SA[1]	CPCI_SA[0]	GND
18	FL_DA24_f+	FL_DA24_f-	GND	FL_DC24_f+	FL_DC24_f-	GND
17	FL_DB24_f+	FL_DB24_f-	GND	FL_DD24_f+	FL_DD24_f-	GND
16	FL_DA8+	FL_DA8-	GND	FL_DC8+	FL_DC8-	GND
15	FL_DB8+	FL_DB8-	GND	FL_DD8+	FL_DD8-	GND
14	FL_DA7+	FL_DA7-	GND	FL_DC7+	FL_DC7-	GND
13	FL_DB7+	FL_DB7-	GND	FL_DD7+	FL_DD7-	GND
12	FL_DA6+	FL_DA6-	GND	FL_DC6+	FL_DC6-	GND
11	FL_DB6+	FL_DB6-	GND	FL_DD6+	FL_DD6-	GND
10	FL_DA5+	FL_DA5-	GND	FL_DC5+	FL_DC5-	GND
9	FL_DB5+	FL_DB5-	GND	FL_DD5+	FL_DD5-	GND
8	FL_DA4+	FL_DA4-	GND	FL_DC4+	FL_DC4-	GND
7	FL_DB4+	FL_DB4-	GND	FL_DD4+	FL_DD4-	GND
6	FL_DA3+	FL_DA3-	GND	FL_DC3+	FL_DC3-	GND
5	FL_DB3+	FL_DB3-	GND	FL_DD3+	FL_DD3-	GND
4	FL_DA2+	FL_DA2-	GND	FL_DC2+	FL_DC2-	GND
3	FL_DB2+	FL_DB2-	GND	FL_DD2+	FL_DD2-	GND
2	FL_DA1+	FL_DA1-	GND	FL_DC1+	FL_DC1-	GND
1	FL_DB1+	FL_DB1-	GND	FL_DD1+	FL_DD1-	GND

3.4.2.4 J4 Connector

- RS232 Interface (RX/TX)

Table 3-7: Connector J4 Pinout

Pin	Row A	Row B	Row C	Row D	Row E	Row F
25	FL20_DA+	FL20_DA-	GND	FL20_DC+	FL20_DC-	GND
24	FL20_DB+	FL20_DB-	GND	FL20_DD+	FL20_DD-	GND
23	FL21_DA+	FL21_DA-	GND	FL21_DC+	FL21_DC-	GND
22	FL21_DB+	FL21_DB-	GND	FL21_DD+	FL21_DD-	GND
21	FL22_DA+	FL22_DA-	GND	FL22_DC+	FL22_DC-	GND
20	FL22_DB+	FL22_DB-	GND	FL22_DD+	FL22_DD-	GND
19	FL23_DA+	FL23_DA-	GND	FL23_DC+	FL23_DC-	GND
18	FL23_DB+	FL23_DB-	GND	FL23_DD+	FL23_DD-	GND
17	NC	NC		NC	NC	GND
16	NC	NC		NC	NC	GND
15	NC	NC		NC	NC	GND
14	Key Area / ocher-yellow peg (ID: 36215)					
13						
12						
11	NC	NC	NC	NC	NC	GND
10	NC	NC	NC	NC	NC	GND
9	FWPD_J4#	NC	GND	RTM_TXD#	RTM_RXD#	GND
8	NC	NC	NC	NC	NC	GND
7	NC	NC	NC	NC	NC	GND
6	NC	NC	NC	NC	NC	GND
5	NC	NC	NC	NC	NC	GND
4	NC	NC	NC	NC	NC	GND
3	NC	NC	NC	NC	NC	GND
2	NC	NC	NC	NC	NC	GND
1	V_5V_HS_RTM_F	V_5V_HS_RTM_F	NC	V_5V_HS_RTM_F	V_5V_HS_RTM_F	GND

The J4 connector provides the rear RS232 interface and the Firmware Write Protect Disable signal. The CP6924 distributes a 5V power supply rail to the RTM via J4. A 4A fuse protects the board from overcurrent or short circuit.

3.4.2.5 J5 Connector

- PICMG 2.16 Link Port 9 to Link Port 19 (10/100/1000Base-T)

Table 3-8: Connector J5 Pinout

Pin	Row A	Row B	Row C	Row D	Row E	Row F
22	FL_DA19+	FL_DA19-	GND	FL_DC19+	FL_DC19-	GND
21	FL_DB19+	FL_DB19-	GND	FL_DD19+	FL_DD19-	GND
20	FL_DA18+	FL_DA18-	GND	FL_DC18+	FL_DC18-	GND
19	FL_DB18+	FL_DB18-	GND	FL_DD18+	FL_DD18-	GND
18	FL_DA17+	FL_DA17-	GND	FL_DC17+	FL_DC17-	GND
17	FL_DB17+	FL_DB17-	GND	FL_DD17+	FL_DD17-	GND
16	FL_DA16+	FL_DA16-	GND	FL_DC16+	FL_DC16-	GND
15	FL_DB16+	FL_DB16-	GND	FL_DD16+	FL_DD16-	GND
14	FL_DA15+	FL_DA15-	GND	FL_DC15+	FL_DC15-	GND
13	FL_DB15+	FL_DB15-	GND	FL_DD15+	FL_DD15-	GND
12	FL_DA14+	FL_DA14-	GND	FL_DC14+	FL_DC14-	GND
11	FL_DB14+	FL_DB14-	GND	FL_DD14+	FL_DD14-	GND
10	FL_DA13+	FL_DA13-	GND	FL_DC13+	FL_DC13-	GND
9	FL_DB13+	FL_DB13-	GND	FL_DD13+	FL_DD13-	GND
8	FL_DA12+	FL_DA12-	GND	FL_DC12+	FL_DC12-	GND
7	FL_DB12+	FL_DB12-	GND	FL_DD12+	FL_DD12-	GND
6	FL_DA11+	FL_DA11-	GND	FL_DC11+	FL_DC11-	GND
5	FL_DB11+	FL_DB11-	GND	FL_DD11+	FL_DD11-	GND
4	FL_DA10+	FL_DA10-	GND	FL_DC10+	FL_DC10-	GND
3	FL_DB10+	FL_DB10-	GND	FL_DD10+	FL_DD10-	GND
2	FL_DA9+	FL_DA9-	GND	FL_DC9+	FL_DC9-	GND
1	FL_DB9+	FL_DB9-	GND	FL_DD9+	FL_DD9-	GND

3.5 Write Protection Feature

The CP6924 supports hardware driven write protection for all non-volatile memory devices. Depending on the device, the protection is implemented either by a dedicated write protection signal, by disabling the write enable signal, or by the whole interface.

Two levels of hardware write protection are supported: standard and enhanced. The protection level is set by a backplane signal (EWP). It is located on connector J4, pin A9. If left open, the signal is inactive. If pulled to GND, the signal is active.

The following table shows how to configure the write protection. Default setting is 'standard'.

EWP Signal	Write Protection Level
Inactive (3.3V or open)	Standard
Active (GND)	Enhanced

4 Software Description

Software on the CP6924-RA-A includes the following parts:

- Bootloader
- initrd (including rootFS, kernel)
- Application software (FASTPATH switching SW)
- IPMI Firmware

The Software accomplishes operation of the switching hardware and is therefore also referenced as firmware. It is pre-installed on the system and can only be updated by a dedicated update procedure. This manual describes bootloader, Linux rootfs/kernel and IPMI firmware, last chapter introduces the update procedures.

For additional information of system configuration using CLI commands refer to documentation "CP6924-RA-A CLI Reference Manual".

4.1 Supported RFCs

The Software supports the following standards and RFCs.

4.1.1 Management

- RFC 854 - Telnet
- RFC 855 - Telnet Option
- RFC 1155 - SMI v1
- RFC 1157 - SNMP
- RFC 1212 - Concise MIB Definitions
- RFC 1867 - HTML/2.0 forms with file upload extensions
- RFC 1901 - Community based SNMP v2
- RFC 1908 - Coexistence between SNMP v1 and SNMP v2
- RFC 2068 - HTTP/1.1 protocol as updated by draft-ietf-http-v11-spec-rev-03
- RFC 2271 - SNMP Framework MIB
- RFC 2295 - Transparent Content Negotiation
- RFC 2296 - Remote Variant Selection; RSVA/1.0 State Management "cookies"
- RFC 2576 - Coexistence between SNMP v1,v2 & v3
- RFC 2578 - SMI v2
- RFC 2579 - Textual Conventions for SMI v2
- RFC 2580 - Conformance statements for SMI v2
- RFC 3410 - Introduction and Applicability Statements for Internet Standard Management Framework
- RFC 3411 - An Architecture for Describing SNMP Management Frameworks

- RFC 3412 - Message Processing and Dispatching (December 2002)
- RFC 3413 - SNMP Applications (December 2002)
- RFC 3414 - User-based Security Model (December 2002)
- RFC 3415 - View-based Access Control Model (December 2002)
- RFC 3416 - Version 2 of SNMP Protocol Operations (December 2002)
- RFC 3417 - Transport Mappings (December 2002)
- RFC 3418 - MIB for the Simple Network Management Protocol.
- SSL 3.0 and TLS 1.0
 - RFC 2246—The TLS protocol, version 1.0
 - RFC 2346—AES cipher suites for Transport layer security
 - RFC 2818—HTTP over TLS
- SSH 1.5 and 2.0
 - RFC 4253—SSH transport layer protocol
 - RFC 4252—SSH authentication protocol
 - RFC 4254—SSH connection protocol
 - RFC 4251—SSH protocol architecture
 - RFC 4716—SECSH public key file format
 - RFC 4419—Diffie-Hellman group exchange for the SSH transport layer protocol
- HTML 4.0 specification, December 1997
- Java[®] Plug-in and Java Script[™] 1.3

Advanced Management Features

- Industry Standard CLI with the following features:
 - Scripting capability
 - Command completion
 - Context-sensitive help
- Optional user password encryption
- Multisession telnet server
- Auto Image Upgrade

4.1.2 Switching

- IEEE 802.1AB—Link level discovery protocol
- IEEE 802.1D—Spanning tree
- IEEE 802.1p—Ethernet priority with user provisioning and mapping
- IEEE 802.1Q—Virtual LANs w/ port-based VLANs
- IEEE 802.1S—Multiple spanning tree compatibility
- IEEE 802.1v—Protocol-based VLANs
- IEEE 802.1W—Rapid spanning tree
- IEEE 802.1X—Port-based authentication
- IEEE 802.3—10BASE-T
- IEEE 802.3u—100BASE-T

- IEEE 802.3ab—1000BASE-T
- IEEE 802.3ac—VLAN tagging
- IEEE 802.3ad—Link aggregation
- IEEE 802.3ae—10 GbE
- IEEE 802.3x—Flow control
- ANSI/TIA-1057—LLDP-MED
- GARP—Generic Attribute Registration Protocol: clause 12, 802.1D-2004
- GMRP—Dynamic L2 multicast registration: clause 10, 802.1D-2004
- GVRP—Dynamic VLAN registration: clause 11.2, 802.1Q-2003
- RFC 4541—IGMP snooping and MLD snooping
- RFC 5171—UniDirectional Link Detection (UDLD) Protocol

Additional Layer 2 Functionality

- Broadcast storm recovery
- Double VLAN/VLAN tagging
- DHCP Snooping
- Dynamic ARP inspection
- Independent VLAN Learning (IVL) support
- IPv6 classification APIs
- Jumbo Ethernet frames
- Port mirroring
- Static MAC filtering
- IGMP and MLD snooping querier
- Port MAC locking
- MAC-based VLANs
- IP source guard
- IP subnet-based VLANs
- Voice VLANs
- Protected ports
- IGMP snooping
- Green Ethernet power savings mode

System Facilities

- Event and error logging facility
- Runtime and configuration download capability
- PING utility
- RFC 768—UDP
- RFC 783—TFTP
- RFC 791—IP
- RFC 792—ICMP
- RFC 793—TCP
- RFC 826—ARP

- RFC 951—BootP
- RFC 1321—Message digest algorithm
- RFC 1534—Interop. between BootP and DHCP
- RFC 2030—Simple Network Time Protocol (SNTP) V4 for IPv4, IPv6, and OSI
- RFC 2131—DHCP Client/Server
- RFC 2132—DHCP options and BootP vendor ext.
- RFC 2865—RADIUS client
- RFC 2866—RADIUS accounting
- RFC 2868—RADIUS attributes for tunnel protocol support
- RFC 2869—RADIUS extensions
- RFC 2886bis—RADIUS support for Extensible Authentication Protocol (EAP)
- RFC 3164—The BSD syslog protocol
- RFC 3580—802.1X RADIUS usage guidelines

4.1.3 Routing

Core features

- RFC 819 - Domain Naming Convention for Internet User Applications
- RFC 826 - Ethernet ARP
- RFC 894 - Transmission of IP datagrams over Ethernet networks
- RFC 896 - Congestion control in IP/TCP networks
- RFC 1027 - Using ARP to implement transparent subnet gateways (Proxy ARP)
- RFC 1256 - ICMP router discovery messages
- RFC 1321 - Message digest algorithm
- RFC 1519 - CIDR
- RFC 1765 - OSPF database overflow
- RFC 1812 - Requirements for IPv4 routers
- RFC 2082 - RIP-2 MD5 authentication
- RFC 2131 - DHCP relay
- RFC 2328 - OSPFv2
- RFC 2453 - RIP v2
- RFC 3021 - Using 31-bit prefixes on Point-to-Point Links
- RFC 3046 - DHCP/BootP relay
- RFC 3101 - The OSPF "Not So Stubby Area" (NSSA) option
- RFC 3768 - Virtual Router Redundancy Protocol (VRRP)
- RFC 3623 - Gracefull OSPF Restart
- Route redistribution across RIP and OSPF
- VLAN routing

4.1.4 QoS

DiffServ

- RFC 2474—Definition of the differentiated services field (DS Field) in the IPv4 and IPv6 headers
- RFC 2475—An architecture for differentiated services
- RFC 2597—Assured forwarding PHB group
- RFC 3246—An expedited forwarding PHB (Per-Hop Behavior)
- RFC 3260—New terminology and clarifications for DiffServ

Access Control Lists (ACL)

- Permit/deny actions for inbound or outbound IP traffic classification based on:
 - Type of service (ToS) or differentiated services (DS) DSCP field
 - Source IP address
 - Destination IP address
 - TCP/UDP source port
 - TCP/UDP destination port
 - IPv6 flow label
 - IP protocol number
- Permit/deny actions for inbound or outbound Layer 2 traffic classification based on:
 - Source MAC address
 - Destination MAC address
 - EtherType
 - VLAN identifier value or range (outer and/or inner VLAN tag)
 - 802.1p user priority (outer and/or inner VLAN tag)
- Optional rule attributes:
 - Assign matching traffic flow to a specific queue
 - Redirect or mirror (flow-based mirroring) matching traffic flow to a specific port
 - Generate trap log entries containing rule hit counts

Class of Service (CoS)

- Direct user configuration of the following:
 - IP DSCP to traffic class mapping
 - IP precedence to traffic class mapping
 - Interface trust mode: 802.1p, IP Precedence, IP DSCP, or untrusted
 - Interface traffic shaping rate
 - Minimum and maximum bandwidth per queue
 - Strict priority versus weighted (WRR/WDRR/WFQ) scheduling per queue
 - Tail drop versus Weighted Random Early Detection (WRED) queue depth management
- Auto VoIP

4.1.5 Multicast

- RFC 1112—Host extensions for IP multicasting
- RFC 2236—IGMP v2
- RFC 2710—MLDv1
- RFC 2365—Administratively scoped boundaries
- RFC 3376—IGMPv3
- RFC 3810—MLDv2
- RFC 3973—PIM-DM
- RFC 4601—PIM-SM
- Draft-ietf-idmr-dvmrp-v3-10—DVMRP
- Draft-ietf-magma-igmp-proxy-06.txt—IGMP/MLD-based multicast forwarding (IGMP/MLD proxying)
- Draft-ietf-magma-igmpv3-and-routing-05.txt—IGMPv3 and multicast routing protocol interaction
- Static RP configuration

4.2 Supported MIBs

The Software supports the following MIBs.

4.2.1 Enterprise MIB

- Support for all managed objects not contained in standards based MIBs.

4.2.2 Base Package MIBs

- RFC 2273 - SNMP Notification MIB, SNMP Target MIB
- RFC 2572 - SNMP Message Processing and Dispatching MIB
- RFC 2574 - User-based Security Model for SNMPv3 MIB
- RFC 2575 - View-based Access Control Model for SNMP MIB
- RFC 2576 - SNMP Community MIB
- RFC 2819 - RMON MIB
- RFC 2925 - DISMAN-PING-MIB and DISMAN-TRACEROUTE-MIB
- RFC 3273 - RMON MIB for High Capacity Networks
- RFC 3411 - SNMP Management Frameworks MIB
- RFC 3418 - SNMPv2 MIB
- RFC 3434 - RMON MIB Extensions for High Capacity Alarms
- RFC 3584 - SNMP Community MIB
- RFC 2580- SNMPV2-CONF
- RFC 1450 - SNMPV2-MIB
- RFC 2578 - SNMPV2-SMI
- RFC 2579 - SNMPV2-TC

- RFC 3417 - SNMPV2-TM
- RFC 3415 - View-based Access Control Model for SNMP MIB
- RFC 3411 - SNMP-FRAMEWORK-MIB
- RFC 3412 - SNMP-MPD-MIB
- RFC 3413 - SNMP-NOTIFICATION-MIB
- RFC 3413 - SNMP-PROXY-MIB (initial revision published as RFC 2273)
- RFC 3413 - SNMP-TARGET-MIB (initial revision published as RFC 2273)
- RFC 3414 - User-based Security Model for SNMPv3 MIB
- SNMP-RESEARCH-MIB- SNMP research MIB definitions
- SR-AGENT-INFO-MIB- SNMP research MIB definitions
- USM-TARGET-TAG-MIB - SNMP research MIB definitions
- IANA-ADDRESS-FAMILY-NUMBERS-MIB (IANA (3/2002)
- IEEE 802.1AB-2004 - LLDP MIB
- IEEE 802.1AB-2005 - LLDP-EXT-DOT3-MIB
- ANSI/TIA-1057 - LLDP-EXT-MED-MIB
- POWER ETHERNET MIB (Draft - no RFC)
- DIFFSERV DSCP TC (Draft - no RFC)
- FASTPATH Greenethernet Private MIB
- RFC 2677 - IANA Address Family Numbers MIB
- RFC 2392 - IANA RTPROTO-MIB
- RFC 1155 - SMI-MIB
- RFC 2613 - SMON-MIB
- RFC 2674 - Q-BRIDGE-MIB
- RFC 3621 - POWER-ETHERNET-MIB
- DNS-RESOLVER-MIB (IETF DNS Working Group)
- DNS-SERVER-MIB (IETF DNS Working Group)

4.2.3 Switching Package MIBs

- RFC 1213 — MIB-II
- RFC 1493 — Bridge MIB
- RFC 1643 — Definitions of managed objects for the Ethernet-like interface types
- RFC 2011 — SNMPv2 Management Information Base
- RFC 2213 — Integrated Services MIB
- RFC 2233 — The Interfaces Group MIB using SMI v2
- RFC 2674 — VLAN and Ethernet Priority MIB (P-Bridge MIB)
- RFC 2737 — Entity MIB (Version 2)
- RFC 2819 — RMON Groups 1,2,3, & 9
- RFC 2863 — Interfaces Group MIB

- RFC 3291 — Textual Conventions for Internet Network Addresses
- RFC 3635 — Etherlike MIB
- RFC 3636 — IEEE 802.3 Medium Attachment Units (MAUs) MIB
- RFC 4022 — Management Information Base for the Transmission Control Protocol (TCP)
- RFC 4113 — Management Information Base for the User Datagram Protocol (UDP)
- RFC 4444 — IS-IS MIB
- RFC 2233 — IF-MIB
- IANAifType-MIB — IANAifType Textual Convention
- RFC 3291 — INET Address MIB
- IEEE LAG-MIB — Link Aggregation module for managing IEEE 802.3ad
- IEEE 802.3AD MIB (IEEE8021-AD-MIB)
- IEEE Draft P802.1AS/D7.0 (IEEE8021-AS-MIB)
- IEEE 802.1AB — LLDP MIB
- LLDP-MIB (part of IEEE Std 802.1AB)
- LLDP-EXT-DOT3-MIB (part of IEEE Std 802.1AB)
- ANSI/TIA 1057 — LLDP-MED MIB
- FASTPATH-MMRP-MIB — MMRP private MIB for IEEE 802.1Q devices
- FASTPATH-MSRP-MIB — MSRP private MIB for IEEE 802.1Q devices
- FASTPATH-MVRP-MIB — MVRP private MIB for IEEE 802.1Q devices
- FASTPATH Enterprise MIBs supporting switching features
- Broadcom Private MIB for 802.1Qat, 802.1Qav Configuration

4.2.4 Routing Package MIBs

- IANA-Address-Family-Numbers-MIB
- RFC 1724 – RIP v2 MIB Extension
- RFC 1850 – OSPF-MIB: OSPF Version 2 Management Information Base
- RFC 2096 – IP Forwarding table MIB
- RFC 2668 – IEEE 802.3 Medium Attachment Units (MAUs) MIB
- RFC 2787 – VRRP MIB: Definitions of Managed Objects for the Virtual Router Redundancy Protocol
- FASTPATH Enterprise MIBs supporting routing features

4.2.5 QoS Package MIBs

- RFC 3289 – DIFFSERV MIB and DIFFSERV-DCSP-TC MIB
- Private MIBs for full configuration of DiffServ, ACL and CoS functionality

4.2.6 Multicast package MIBs

- RFC 2932 – IPv4 multicast routing MIB
- RFC 5060 – PIM-SM and PIM-DM MIB for IPv4 and IPv6
- RFC 5240 – BSR Protocol MIB
- Draft-ietf-idmr-dvmrp-mib-11.txt – DVMRP MIB
- Draft-ietf-magma-mgmd-mib-05.txt – Multicast group membership discovery MIB
- FASTPATH Enterprise MIBs supporting multicast features

4.2.7 Security MIBs

- RFC 2618 - RADIUS Authentication Client MIB
- RFC 2620 - RADIUS Accounting MIB
- IEEE 8021-PAE-MIB - The Port Access Entity module for managing IEEE 802.1X
- IEEE 802.1X MIB (IEEE 8021-PAE-MIB 2004 Revision)

4.2.8 Kontron Private MIBs

For the CP6924-RA-A, Kontron provides several MIBs in addition to the Standard MIBs (see “Supported MIBs” on page 39) that allows to use SNMP for configuration of :

- IPMI features
- extended Ethernet features
- Geographical Address
- extended management features

Kontron specific MIBs start with a “kex_”. Here’s a list of MIBs provided (in this example for release GA 2.0) including its content:

- kex_config
 - Set BSP startup services
 - Handle arbitrary config. files
 - DHCP Server packet manipulation
 - ACL Trap Sleep Time
 - DHCP Client Identifier
 - Delete File and extra-profile
 - user-timer settings
 - Selectable port map
 - Error counters
- kex-debug
 - Debug information
- kex_ipmi
 - Basic IPMI features:
 - Sensor list
 - SEL entries
 - FRU entries
 - FRU-Device information
- kex_mgmt
 - Egress COS drop counter
 - Protection Port Groups
 - Advertise Speed
 - LAG multicast hashing
 - VLAN multicast flooding
 - Port multicast flooding
 - LAG unicast enhanced hashing
 - Send IGMP reports (proxy)

- CPU load
- Suppress MAC learning
- Fast Reload
- Memory Usage
- L2 port bridge
- Port blocking mode
- BPDU forwarding
- Suppress MAC learning
- kex_oem
 - Customer specific information
 - OEM serial number
 - OEM hardware part number
 - OEM software part number
 - OEM software configuration
- kex_phy
 - SFP/SFP+/QSFP information
 - Status (present), auto/isolate/auto-configuration mode, Ethernet protocol, LOS/Transmit-Fault
 - EEPROM content
 - Present trap
- kex_ref
 - basic Kontron Information
- kex_sensor
 - common sensor list
- kex_version
 - FASTPATH version
 - Chip information
 - Address information (GA/SGA address)
 - Board information (name, part-number, serial-number, manufacturer, MAC address)
 - Firmware versio0n (e.g. PLD) and write protect status
 - System and IPMI release

To use the MIBs, you must import the MIBs into the MIB browser. The MIBs are provided on demand for current releases. SNMP can also be used for updating System Software, IPMI FW and PLD.

4.3 Bootloader

On the CP6924-RA-A Ethernet Switch, the bootloader 'u-boot' (universal bootloader) is used. The bootloader initializes the main components of the system like Unit Computer, DDR2 RAM, serial lines etc. for operation and performs a power on self test (POST). After these steps have been finished, kernel and application are started from flash.

The bootloader software consists of two parts, boot firmware and boot monitor. The boot firmware is stored in the write-protected boot sector of the flash device. It mainly checks the integrity of the boot monitor image by calculating a CRC checksum and jumps into the boot monitor if the checksum is valid.

In case the boot monitor image is corrupted for some reason, the boot firmware switches into a CLI with reduced function set and tries to recover the boot monitor.

4.3.1 Power On Self Test

4.3.1.1 Test Routines

Upon power on or system reset, the bootloader performs the following power on self tests (POST):

Table 4-1: POST tests

Test	Description
Serial	Onboard Unit Computer serial controller loopback test
I2C	Check for presence of onboard I2C devices
PCI Express	Check for PCI Express switch device presence
Serviceport	Onboard PPC405EX ethernet internal loopback test
Bootloader environment	Check for valid bootloader environment (CRC correct or both CRCs are 0xFFFFFFFF == not initialized)
VPD area	Check for valid VPD area (CRC is valid)
DDR RAM data/address lines	Data/address line test. Checks for stucked or shortened data/address lines
DDR RAM memory cells	Checkerboard standard test algorithm
Cache	PPC405EX data and instruction cache
KCS	KCS Interface communication

The POST result is stored in the transient environment variable 'postresult'. If no POST error occurred, postresult is set to '0', otherwise - depending on the actual POST error - postresult is set as shown in table 4-2 below.

The 'postresult' value is passed to the linux kernel by means of the 'bootargs' environment variable.

The following table shows the POST code values written into the 'postresult' environment variable.

Table 4-2: POST routines and error codes

Device	Test
0x00	All POST were successful
0x01	Serial POST failed
0x02	I2C POST failed
0x04	PCIe POST failed
0x08	Ethernet POST failed
0x10	Bootloader environment POST failed
0x20	VPD POST failed
0x40	Memory data/address line POST failed
0x80	Memory device cells POST failed
0x100	CPU cache POST failed
0x200	KCS POST failed

4.3.2 Bootloader Shell Options

The boot process can be interrupted by entering the bootstopkey phrase “stop”. This will open a bootloader shell session.

Entering “?” provides a list of possible built-in commands, “printenv” provides a list of current environment settings. The bootloader shell can be used to customize boot options and system startup by changing some of its environment variables. A list of available environment variables and its description can be seen in the table below.

Table 4-3: Bootloader Environment Variables

Name	Type	Description
baudrate	Var	Serial line baudrate default: 115200
bootargs	Var	Default kernel arguments. (quiet postresult=0x\${postresult} \${vram_kinfo})
bootcmd	Script	This variable defines a command string that is automatically executed when the initial countdown is not interrupted. This command is only executed when the variable bootdelay is also defined!
bootcmdcli	Script	contains startup script which will drop to CLI and wait. This is used in case that the system detects a rollback failed condition (rollback_ctl = 1).
bootcmdflash	Script	contains the standard startup script for loading OS image from flash partition command. This will load the Linux kernel and start it with a INITRD type root file system.
bootcmdnet	Script	contains the standard startup script for loading OS image from network.
bootcmdprd	Script	contains the standard startup script for use during board production.
bootcmdrecovery	Script	contains standard startup script for board firmware recovery in boot firmware.
bootcmdrollback	Script	contains standard startup script for board firmware rollback from backup partition after a CRC checksum error has been detected.
check bootsource	Script	check for user defined bootcmd/bootargs pair.
check rollback	Script	check whether previous rollback failed and drop into bootloader CLI.
bootdelay	Var	After reset, U-Boot will wait this number of seconds before it executes the contents of the bootcmd variable. During this time a countdown is printed, which can be interrupted by pressing any key. Set this variable to 0 boots without delay. Be careful: depending on the contents of your bootcmd variable, this can prevent you from entering interactive commands again forever! Set this variable to -1 to disable autoboot. default: 3 for boot monitor, 10 for boot write-protected boot firmware.
bootsource	Var	When the standard boot sequence is used, contains the boot source, either flash, net, prd to select the respective boot sequence to activate. It is only used when bootcmd contains the default startup script, which may be overridden by the user. default: flash
bootstopkey	Var	Defines the key phrase that the user needs to type to drop into the bootloader command line interface during startup. not set – use string “stop” as bootstop key phrase (default) <any> - use string <any> as bootstop key phrase
check bootsource	Script	Check for user defined bootsource extensions and execute them
check rollback	Script	Check for rollback prerequisites and start 'run rollback_flash' script
clear_config	Script	Erase config partition to restore factory defaults for Linux BSP settings.
clear_env	Script	Erase U-Boot environment sectors.
disable_rollback	Var	0 – rollback when CRC check of kernel or rootfs fails (default) 1 – do not rollback
ethact	Var	Default network interface used by network commands (bootp, tftpboot et al) default: ppc_4xx_eth0

Table 4-3: Bootloader Environment Variables (Continued)

Name	Type	Description
ethaddr	Auto	contains the default base MAC address of the board which is read from VPD area. If ethaddr environment variable is changed and stored using 'saveenv', this value will override VPD setting after board restart.
flash_update	Script	Command script to flash a Linux kernel and rootfs image transferred with tftpbboot to the active Linux kernel and rootfs partition
loadaddr	Var	Default load address for network transfers. This is used as a temporary storage for netbooting and firmware updates. default: 0x20000000
memtest	Var	Controls POST memory test execution: 0: only data and address line test is executed 1: fast memory test with checkerboard pattern (tests 4MB of memory divided on different 128kB memory chunks) 2: full memory test with checkerboard pattern If not set, the fast memory test is performed
pciconfighost	Var	If set to 1, do not skip host bridge configuration default: 1
postresult	Auto	Stores the POST result 0 – no POST error occurred 1 – a POST error occurred
reset_unknown	Var	0 – do not cold reset when unknown reset type is detected 1 – enable cold reset when unknown reset type is detected (default)
rollback_flash	Script	Recovers flash contents from backup image in case of CRC checksum failure on startup
rollbackctl	Script	Environment script to handle rollback success/fail conditions
rollback_ctl	Auto	This flag is set by the 'imcp' command which is executed during rollback to indicate whether a previous rollback failed or succeeded. 1 - previous rollback failed 0 - previous rollback succeeded
setbootargs	Script	This command is used before execution of the boot command to setup kernel command line properly with current postresult and vram_kinfo values
watchdogboot	Var	0 – disable boot monitor watchdog 5...n – timeout in seconds before boot monitor watchdog fires default: 45 Note: This is the pBMWD watchdog.
watchdogos	Var	0 – disable OS load watchdog 15..dis.n – timeout in seconds before load OS watchdog fires default: 45 Note: This is the pOSWD watchdog.

There are three different types of bootloader environment variables:

- **Script:** The variable is a set of consecutive (more simple) bootloader commands to perform a specific task. A command script is invoked using the 'run <script>' syntax. E.g. the 'run clear_env' command would erase the bootloader environment sectors causing the bootloader to use its default environment upon next restart.
- **Var:** The variable controls a specific behaviour of the bootloader startup sequence. E.g. the 'bootdelay' variable controls the time u-boot waits before execution of the bootcmd which normally loads and starts the linux kernel.
- **Auto:** The variable is automatically set during bootloader startup sequence. E.g. the 'postresult' variable stores the result of the POST.

It is possible to modify environment variables and start the pre-defined scripts from the bootloader shell. It is strongly discouraged to modify the pre-defined script variables. However, definition and execution of user-defined script variables can be done.



Note...

Meddling with the bootloader environment variables can affect significantly the startup sequence of the system and may cause the system to be un-bootable.

Modification of bootloader environment variables is done using the 'setenv' and 'saveenv' bootloader CLI commands. With the 'bootextensions' environment variable, user can setup his own bootcmd and bootargs variables and run his script automatically by setting the 'bootsource' variable appropriately. In the following example, the new environment script variable 'bootcmdmyname' as well as 'bootargsmyname' are defined. After that, the 'bootsource' is set to <name> causing the bootloader to setup <bootargsmyname> and execute <bootcmdmyname> upon next restart.

```
=> setenv bootextensions myname
=> setenv bootargsmyname 'setenv bootargs quiet mem=384M'
=> setenv bootcmdmyname 'bootp; tftpboot ${loadaddr} myimg.multi; bootm ${loadaddr}'
=> setenv bootsource myname
=> saveenv
```

Environment changes are stored in one of the redundant bootloader environment sectors. In case of failure (e.g. environment sector corruption), the settings of the redundant sector are still available. However, the fabric default setting is running with environment sectors erased. In this case the following startup message is displayed:

```
ENV: Using default environment
```

Any changes of the environment can be cleared using the 'clear_env' script (provided that 'clear_env' itself was not changed):

```
=> run clear_env
```

4.3.3 Bootloader Pushbutton Reset

When the pushbutton is pressed, the CP6924-RA-A glue logic performs a SysReset to the CPU. After reset has been issued, the board will restart with boot source 'Pushbutton' displayed on the serial console.

If the pushbutton has been pressed for more than 3s, bootloader will detect this and drop into the boot firmware shell immediately. In addition, the watchdog will be stopped. This allows to get into the bootloader shell in case of severe errors, e.g. if a boot monitor has been installed with valid checksum but un-bootable.

4.3.4 Bootloader Rollback Control

During board startup sequence, both boot monitor and linux system image checksums are checked before the respective image is started. In case of a checksum error, automatic rollback mechanism is started, that overwrites corrupted flash sectors with those located in the flash backup partition. After this has been finished, the board reboots and starts from recovered image sectors now.

In case that the flash backup partition does not contain a valid backup image, checksum test will still fail after reboot resulting in an endless flash recovery - reboot cycle. To avoid this, the rollback command sets a bit in non-volatile CPLD scratchpad register 0x1 which keeps its contents over CPU reset as long as the board is not switched off. If the following CRC check still detects flash corruption _and_ the scratchpad register bit is set, bootloader will switch off watchdog, drop into CLI and wait.

4.4 IPMI Firmware

The Switch Management Controller communicates with the onboard Module Management Controller (MMC) using the Keyboard Controller Style (KCS) interface. The bootloader is able to communicate with the MMC, e.g. for POST error logging purposes and fault resilient purposes.

The memory subsystem of the MMC consists of an integrated flash memory to hold the MMC operation code and integrated RAM for data. The field replaceable unit (FRU) inventory information is stored in the nonvolatile memory on an EEPROM connected via a local I2C interface to the MMC microcontroller. It is possible to store up to 4 Kbytes within the FRU inventory information. Communication over IPMB bus to the BMC ensures that 'post-mortem' logging information is available even if the main processor becomes disabled.

The onboard DC voltage, current, and temperature sensors are monitored by the MMC continuously. The MMC will log an event into the BMC's System Event Log (SEL) if any of the thresholds are exceeded.

To increase the reliability of the Board management subsystem, an external watchdog supervisor for the MMC is implemented. The MMC strobes the external watchdog within 800 millisecond intervals to ensure continuity of operation of the board's management subsystem. The MMC watchdog supervisor does not reset the payload power and the restart of the MMC will not affect the payload. The external watchdog supervisor is not configurable and must not be confused with the IPMI v1.5 watchdog timer commands.

This external watchdog of the MMC is implemented inside the PLD and is used to supervise the operational state of the MMC.

4.4.1 Supported IPMI Commands

4.4.1.1 Standard Commands

Part of the command list in IPMI specification 2.0

M = mandatory, 0 = optional

Table 4-4: Standard Commands

Command	IPMI 2.0 Spec. section	NetFn	CMD	Support on CP6924-RA-A
IPM Device "Global" Commands				M
Get Device ID	20.1	App	01h	M / Yes ^[1]
Cold Reset	20.2	App	02h	0 / Yes
Get Self Test Results	20.4	App	04h	0 / Yes
Manufacturing Test On	20.5	App	05h	0 / Yes
Broadcast "Get Device ID"	20.9	App	01h	M / Yes
BMC Watchdog Timer Commands				0
Reset Watchdog Timer	27.5	App	22h	0 / Yes
Set Watchdog Timer	27.6	App	24h	0 / Yes
Get Watchdog Timer	27.7	App	25h	0 / Yes
BMC Device and Messaging Commands				0
Set BMC Global Enables	22.1	App	2Eh	0 / Yes
Get BMC Global Enables	22.2	App	2Fh	0 / Yes
Clear Message Flags	22.3	App	30h	0 / Yes
Get Message Flags	22.4	App	31h	0 / Yes
Enable Message Channel Receive	22.5	App	32h	0 / Yes
Get Message	22.6	App	33h	0 / Yes
Send Message	22.7	App	34h	0 / Yes
Read Event Message Buffer	22.8	App	35h	0 / Yes
Get Channel Info	22.24	App	42h	0 / Yes

Table 4-4: Standard Commands (Continued)

Command	IPMI 2.0 Spec. section	NetFn	CMD	Support on CP6924-RA-A
Chassis Commands				M
Chassis Control	28.3	Chassis	02h	0 / Yes
Event Commands				M
Set Event Receiver	29.1	S/E	01h	M / Yes
Get Event Receiver	29.2	S/E	02h	M / Yes
Platform Event (a.k.a. "Event Message")	29.3	S/E	03h	M / Yes
Sensor Device Commands				M/O
Get Device SDR Info	35.2	S/E	20h	M / Yes
Get Device SDR	35.3	S/E	21h	M / Yes
Reserve Device SDR Repository	35.4	S/E	22h	M / Yes
Set Sensor Hysteresis	35.6	S/E	24h	0 / Yes
Get Sensor Hysteresis	35.7	S/E	25h	0 / Yes
Set Sensor Threshold	35.8	S/E	26h	0 / Yes
Get Sensor Threshold	35.9	S/E	27h	0 / Yes
Set Sensor Event Enable	35.10	S/E	28h	0 / Yes
Get Sensor Event Enable	35.11	S/E	29h	0 / Yes
Get Sensor Reading	35.14	S/E	2Dh	M / Yes
FRU Device Commands				M
Get FRU Inventory Area Info	34.1	Storage	10h	M / Yes
Read FRU Data	34.2	Storage	11h	M / Yes
Write FRU Data	34.3	Storage	12h	M / Yes
SEL Device Commands				M
Get SEL Info	31.2	Storage	40h	0 / Yes
Get SEL Allocation Info	31.3	Storage	41h	0 / Yes
Reserve SEL	31.4	Storage	42h	0 / Yes
Get SEL Entry	31.5	Storage	43h	0 / Yes
Add SEL Entry	31.6	Storage	44h	0 / Yes
Delete SEL Entry	31.8	Storage	46h	0 / Yes
Clear SEL	31.9	Storage	47h	0 / Yes
Get SEL Time	31.10	Storage	48h	0 / Yes
Set SEL Time	31.11	Storage	49h	0 / Yes

[1] Has oem extensions

Table 4-5: HPM.1 Commands

Command name	Standard	Code	Support on CP6924-RA-A
Get Target Upgrade Capabilities	HPM.1	2Eh	YES
Get Component Properties	HPM.1	2Fh	YES
Abort Firmware Upgrade	HPM.1	30h	YES
Initiate Upgrade Action	HPM.1	31h	YES
Upload Firmware Block	HPM.1	32h	YES
Finish Firmware Upload	HPM.1	33h	YES
Get Upgrade Status	HPM.1	34h	YES
Activate Firmware	HPM.1	35h	YES
Query Self-Test Results	HPM.1	36h	YES
Query Rollback Status	HPM.1	37h	YES
Initiate Manual Rollback	HPM.1	38h	YES

4.4.1.2 Kontron OEM Commands And Extensions

Table 4-6: Kontron OEM Commands

Command	NetFn	LUN	Code
OemApSetControlState	3Eh	0	20h
OemApGetControlState	3Eh	0	21h
OemApGetFirmwareSysUpTime	3Eh	3	03h
OemApFormatStorage	3Eh	3	09h
OemApSetSdrLocatorString	3Eh	3	0Ah
OemApSetSerialNumber	3Eh	3	0Bh
OemApGetSerialNumber	3Eh	3	0Ch
OemApSetManufacturingDate	3Eh	3	0Dh
OemApGetManufacturingDate	3Eh	3	0Eh
OemApSetNvData	3Eh	3	0Fh
OemApGetNvData	3Eh	3	10h
OemApSetNvSensConfig	3Eh	3	12h
OemApGetNvSensConfig	3Eh	3	13h
OemApLoadNvDefaults	3Eh	3	14h
OemApFpgaWriteRead	3Eh	3	62h
OemApGetReleaseInfo	30h	3	01h
OemApSetResetReason	3Eh	3	07h
OemApReadVariableValue	3Eh	3	69h
OemApRefreshExternUpdatedSensor	3Eh	3	01h

Get Device ID Command with OEM Extensions

	LUN	NetFn	CMD
GetDeviceID	3	App = 06h	01h

	Byte	Data Field
Request Data	-	-
Response Data	1	Completion Code
	2	Device ID 10h = Kontron IPMC based on NXP Microcontroller
	3	Device Revision [7] - 1b = device provides Device SDRs [6-0] - 0000000b = Reserved
	4	Firmware Revision [7] - 0b = normal operation [6:0] - Major Firmware Revision (depends on OEM software major release number)
	5	Firmware Revision 2 Minor Firmware Revision, BCD encoded (depends on OEM software minor release number)
	6	IPMI Version 51h - IPMI version 1.5
	7	Additional Device Support [7] - 1b = device does implement chassis device support [6] - 0b = device does not implement bridge device support [5] - 1b = device generates event messages onto the IPMB [4] - 1b = device does not accepts event messages from the IPMB [3] - 1b = device implements a FRU device repository [2] - 1b = device does implement a SEL [1] - 1b = device does implement a SDRR [0] - 1b = device implements sensors
	8 - 10	Manufacturer ID 15000 983A00h = Kontron
	11 - 12	Product ID 1704 6A8h = S1704
	13	Auxiliary Firmware Revision Information 1 (variable) - Sensor version information
	14	Auxiliary Firmware Revision Information 2 (variable) - add-in card site number
	15	Auxiliary Firmware Revision Information 3 (variable) - maintenance revision
16	Auxiliary Firmware Revision Information 4 00h - reserved	

Example:

```
# ipmitool bmc info
Device ID           : 16
Device Revision    : 0
Firmware Revision  : 0.90
IPMI Version       : 1.5
Manufacturer ID    : 15000
Manufacturer Name   : Kontron
Product ID         : 1704 (0x06a8)
Product Name       : Unknown (0x6A8)
Device Available   : yes
Provides Device SDRs : yes
Additional Device Support :
  Sensor Device
  SEL Device
  FRU Inventory Device
  IPMB Event Receiver
  IPMB Event Generator
  Chassis Device
Aux Firmware Rev Info :
  0x00
  0x02
  0x03
  0x00
```

OemApFormatStorage Command

This command re-formats the I2C EEPROM attached to the IPMC. This clears the FRU data storage, the SEL storage and resets the NV parameter database to the default values. This command also causes the MMC to reset.

	LUN	NetFn	CMD
OemApFormatStorage	3	OEM = 3Eh	09h

	Byte	Data Field
Request data	1	Pass Code 0: ~'K'
	2	Pass Code 1: ~'o'
	3	Pass Code 2: ~'n'
	4	Pass Code 3: ~'t'
Response data	1	Completion Code

OemApSetNvData / OemApGetNvData Command

These commands provide raw access to the internally held parameter database that is stored inside the I2C EEPROM attached to the IPMI controller.

	LUN	NetFn	CMD
oemApSetNvData	3	OEM = 3Eh	0Fh

	Byte	Data Field
Request data	1	Pass Code 0: ~'K'
	2	Pass Code 1: ~'o'
	3	Pass Code 2: ~'n'
	4	Pass Code 3: ~'t'
	5	NV Data Param ID
	6..N	Raw data
Response data	1	Completion code

OemApFpgaWriteRead Command

This command can be used to read multiple data bytes from or write one data to the register interface provided by the glue logic attached to the MMC.

	LUN	NetFn	CMD
oemApFpgaWriteRead	3	OEM = 3Eh	14h

	Byte	Data Field
Request data	1	Pass Code 0: ~'K'
	2	Pass Code 1: ~'o'
	3	Pass Code 2: ~'n'
	4	Pass Code 3: ~'t'
	5	Register offset
	6	Read data count N
	7	Write data
	8	Write data mask
Response data	1	Completion Code
	2..N	Read data

OemApLoadNvDefaults Command

This command is used to re-initialize the parameter database to its default values.

	LUN	NetFn	CMD
oemApLoadNvDefaults	3	OEM = 3Eh	62h

	Byte	Data Field
Request data	1	Pass Code 0: ~'K'
	2	Pass Code 1: ~'o'
	3	Pass Code 2: ~'n'
	4	Pass Code 3: ~'t'
Response data	1	Completion Code

4.4.2 Board Sensors

The Management Controller includes many sensors for voltage or temperature monitoring and various others for pass/fail type signal monitoring.

Every sensor is associated with a Sensor Data Record (SDR). Sensor Data Records contain information about the sensors identification such as sensor type, sensor name, sensor unit. SDRs also contain the configuration of a specific sensor such as thresholds, hysteresis, event generation capabilities, etc. that specify the sensor's behavior. Some fields of the sensor SDR are configurable through IPMI v1.5 command and are set to a built-in initial value.

Module sensors that have been implemented are listed in the sensor list in Table 4-7.

4.4.2.1 Sensor List

Please note that the IPMI tool 'ipmitool' displays for command 'ipmitool sdr list' the contents of the sensor data record repository (SDRR) of the whole rack if the SDRR is generated. The generation of the SDRR has always to be done new after adding or subtracting any board to or from the rack.

For OEM (Kontron) specific sensor types and reading types in the following table please refer to the next chapter.

Table 4-7: Sensor List

SDR Record ID	Sensor Nr	Sensor ID	Sensor Type Code	Description
0	NA	CP6924		FRU Device Locator Record
1	0	Sxx:T_PCB	01h (Temperature)	Board thermal sensor
2	1	Sxx:T_PHY1	01h (Temperature)	PHY1 thermal sensor
3	2	Sxx:T_PHY2	01h (Temperature)	PHY2 thermal sensor
4	3	Sxx:T_PHY3	01h (Temperature)	PHY3 thermal sensor
5	4	Sxx:V_0V9_VTT	01h (Voltage)	Payload Voltage
6	5	Sxx:V_1V0	01h (Voltage)	Payload Voltage
7	6	Sxx:V_1V2	01h (Voltage)	Payload Voltage
8	7	Sxx:V_1V25	01h (Voltage)	Payload Voltage
9	8	Sxx:V_1V8	01h (Voltage)	Payload Voltage
10	9	Sxx:V_2V5	01h (Voltage)	Payload Voltage
11	10	Sxx:V_3V3	01h (Voltage)	Payload Voltage
12	11	Sxx:V_3V3_SUS	01h (Voltage)	Suspend Voltage
13	12	Sxx:V_3V3_CPLD	01h (Voltage)	Suspend CPLD Voltage
14	13	Sxx:V_3V3_CPCI	01h (Voltage)	CPCI Voltage
15	14	Sxx:V_5V0_CPCI	01h (Voltage)	CPCI Voltage
16	15	Sxx:V_5V0_IPMB	01h (Voltage)	IPMB Voltage
17	16	Sxx:I_3V3_CPCI	03h (Current)	CPCI Current
18	17	Sxx:I_5V0_CPCI	03h (Current)	CPCI Current
19	18	Sxx:IPMBL State	C3h (OEM IPMB link state)	
20	19	Sxx:MMC Reboot	24h (Platform Alert)	IPMI Firmware changed indication
21	20	Sxx:MMC FwUp	C7h (OEMIPMC Firmware Upgrade)	
22	21	Sxx:Ver change	2Bh (Version Change)	Firmware Version Change
23	22	Sxx:IniAgent Err	C2h (OEM Init Agent Error)	
24	23	Sxx:IPMI Watchdog	23h (Watchdog 2)	
25	24	Sxx:POST Fail	0Fh (System Firmware)	System Firmware POST Error
26	25	Sxx:Boot Fail	1Eh (Boot Error)	Primary CPU boot failure
27	26	Sxx:System Restart	1Dh (System Boot)	
28	27	Sxx:IPMI Info-1	C0h (OEM Firmware Info)	
29	28	Sxx:IPMI Info-1	C0h (OEM Firmware Info)	

Example

```
# ipmitool sdr list
S02:T_PCB | 32 degrees C | ok
S02:T_PHY1 | 53 degrees C | ok
S02:T_PHY2 | 64 degrees C | ok
S02:T_PHY3 | 44 degrees C | ok
S02:V_OV9_VTT | 0.90 Volts | ok
S02:V_1V0 | 1.03 Volts | ok
S02:V_1V2 | 1.19 Volts | ok
S02:V_1V25 | 1.28 Volts | ok
S02:V_1V8 | 1.88 Volts | ok
S02:V_2V5 | 2.60 Volts | ok
S02:V_3V3 | 3.41 Volts | ok
S02:V_3V3_SUS | 3.41 Volts | ok
S02:V_3V3_PLD | 3.41 Volts | ok
S02:V_3V3_CPCI | 3.36 Volts | ok
S02:V_5V0_CPCI | 5.20 Volts | ok
S02:V_5V0_IPMB | 0 Volts | ok
S02:I_5V0_CPCI | 0 Amps | ok
S02:I_3V3_CPCI | 0 Amps | ok
S02:IPMBL State | 0 unspecified | nc
S02:MMC Reboot | 0 unspecified | ok
S02:MMC FwUp | 0 unspecified | ok
S02:Ver change | 0x00 | ok
S02:Boot Fail | 0 unspecified | ok
S02:POST Fail | 0 unspecified | ok
S02:IPMI Watchdog | 0 unspecified | ok
S02:System Restart | 0 unspecified | ok
S02:IPMI Info-1 | 0x00 | ok
S02:IPMI Info-2 | 0x00 | ok

# ipmitool sensor
0 | S02:CP6924 | Dynamic MC @ B2h | ok
1 | S02:T_PCB | 32.000 | degrees C | ok | na | na | na | na | na | na
2 | S02:T_PHY1 | 52.000 | degrees C | ok | na | na | na | na | na | na
3 | S02:T_PHY2 | 64.000 | degrees C | ok | na | na | na | 91.000 | 101.000 | na
4 | S02:T_PHY3 | 43.000 | degrees C | ok | na | na | na | 75.000 | 85.000 | 95.000
5 | S02:V_OV9_VTT | 0.903 | Volts | ok | na | na | na | 75.000 | 85.000 | 95.000
6 | S02:V_1V0 | 1.028 | Volts | ok | na | na | na | 75.000 | 85.000 | 95.000
7 | S02:V_1V2 | 1.198 | Volts | ok | na | na | na | 75.000 | 85.000 | 95.000
8 | S02:V_1V25 | 1.277 | Volts | ok | na | na | na | na | na | na
9 | S02:V_1V8 | 1.880 | Volts | ok | na | na | na | na | na | na
10 | S02:V_2V5 | 2.583 | Volts | ok | na | na | na | na | na | na
11 | S02:V_3V3 | 3.407 | Volts | ok | na | na | na | na | na | na
12 | S02:V_3V3_SUS | 3.407 | Volts | ok | na | na | na | na | na | na
13 | S02:V_3V3_CPL D | 3.407 | Volts | ok | na | na | na | na | na | na
14 | S02:V_3V3_CPCI | 3.358 | Volts | ok | na | na | na | na | na | na
15 | S02:V_5V0_CPCI | 5.200 | Volts | ok | na | na | na | na | na | na
16 | S02:V_5V0_IPMB | 0.000 | Volts | cr | na | na | na | na | na | na
17 | S02:I_5V0_CPCI | 0.000 | Amps | ok | na | na | na | na | na | na
18 | S02:I_3V3_CPCI | 0.000 | Amps | ok | na | na | na | na | na | na
19 | S02:IPMBL State | 0x11 | discrete | 0x0880 | na | na | na | na | na | na
20 | S02:MMC Reboot | 0x0 | discrete | 0x0080 | na | na | na | na | na | na
21 | S02:MMC FwUp | 0x0 | discrete | 0x0080 | na | na | na | na | na | na
22 | S02:Ver change | 0x0 | discrete | 0x0080 | na | na | na | na | na | na
25 | S02:Boot Fail | 0x0 | discrete | 0x0080 | na | na | na | na | na | na
24 | S02:POST Fail | 0x0 | discrete | 0x0080 | na | na | na | na | na | na
26 | S02:IPMI Watchdog | 0x0 | discrete | 0x0080 | na | na | na | na | na | na
27 | S02:System Restart | 0x0 | discrete | 0x0080 | na | na | na | na | na | na
28 | S02:IPMI Info-1 | 0x0 | discrete | 0x0080 | na | na | na | na | na | na
29 | S02:IPMI Info-2 | 0x0 | discrete | 0x0080 | na | na | na | na | na | na
```

Please note, Numbering at the beginning of each line of the ipmitool sensors command output shows SDR Record IDs.

4.4.2.2 OEM Sensors

OEM IPMB Link (Type C3h)**Table 4-8: IPMB Link (Type C3h) Reading**

	Offset	
Request data	1	Sensor Number
Response data	1	Completion Code
	2	Sensor Reading [7:4] – Reserved, ignore on read [3] – IPMB-L Override State 0b = override state, bus isolated 1b = local control state, MMC determines state of the bus [2:0] – IPMB-L Local State 0h = no failure, bus enabled 1h = unable to drive clock high 2h = unable to drive data high 3h = unable to drive clock low 4h = unable to drive data low 5h = clock low timeout 6h = under test (MMC is attempting to determine if it is causing a bus hang) 7h = undiagnosed communication failure
	3	Standard IPMI Byte. (See “Get Sensor Reading in the IPMI Specification)
	4	[7:2] – Reserved, read as zero [1] – 1b = IPMB-L enabled [0] – 1b = IPMB-L disabled
	5	80h – Ignore on read

Table 4-9: IPMB Link (Type C3h) Event Message

	Offset	
Request data	1	Event Message Rev 04h
	2	Sensor Type F2h – Module Hot Swap
	3	Sensor Number
	4	[7] – Event Direction 1b = Deassertion 0b = Assertion [6-0] – Event Type 6Fh = Generic Availability
	5	Event Data 1 [7:4] – Ah = OEM code in Event Data 2 and 3 [3:0] – Offset 00h = IPMB-L disabled 01h = IPMB-L enabled All other values are reserved.
	6	Event Data 2 [7:0] Reserved, read as zero
	7	Event Data 3 [7:4] – Reserved, read as zero [3] – IPMB-L Override State 0b = override state, bus isolated 1b = local control state, MMC determines state of the bus [2:0] – IPMB-L Local Status 0h = no failure, bus enabled 1h = unable to drive clock high 2h = unable to drive data high 3h = unable to drive clock low 4h = unable to drive data low
Response data	1	Completion Code

MMC Reboot (Type 24h)

Table 4-10: MMC Reboot (Type 24h) Reading

	Offset	
Request data	1	Sensor Number
Response data	1	Completion Code
	2	Sensor Reading 00h – ignore on read
	3	Standard IPMI Byte. (See “Get Sensor Reading in the IPMI Specification)
	4	[7:2] – Reserved, read as zero [1] – 1b = MMC in Reset [0] – 1b = MMC out of Reset
	5	80h – Ignore on read

Table 4-11: MMC Reboot (Type 24h) Event Message

	Offset	
Request data	1	Event Message Rev 04h
	2	Sensor Type 24h – Platform Alert
	3	Sensor Number
	4	[7] – Event Direction 1b = Deassertion 0b = Assertion [6-0] – Event Type 03h = digital discrete
	5	Event Data 1 [7:4] – 0h = no data in Event Data 2 and 3 [3:0] – Offset 00h = MMC out of Reset 01h = MMC in Reset All other values are reserved.
	6	Event Data 2 FFh = not specified
	7	Event Data 3 FFh = not specified
Response data	1	Completion Code

SDR Configuration	Value	Description
Assertion Event Mask	02h	Offset 1 can generate an assertion event
Deassertion Event Mask	00h	Sensor cannot generate deassertion events

MMC FwUp (Type C7h)

Table 4-12: MMC FwUp (Type C7h) Reading

	Offset	
Request data	1	Sensor Number
Response data	1	Completion Code
	2	Sensor Reading 00h = first boot after upgrade 01h = first boot after rollback All other values are reserved.
	3	Standard IPMI Byte. (See "Get Sensor Reading in the IPMI Specification")
	4	00h - ignore on read
	5	80h - ignore on read

Table 4-13: MMC FwUp (Type C7h) Event Message

	Offset	
Request data	1	Event Message Rev 04h
	2	Sensor Type C7h - OEM Firmware Upgrade
	3	Sensor Number
	4	[7] - Event Direction 1b = Deassertion 0b = Assertion [6-0] - Event Type 6Fh = sensor specific
	5	Event Data 1 [7:4] - 0h = no data in Event Data 2 and 3 [3:0] - Offset 00h = first boot after upgrade 01h = first boot after rollback All other values are reserved.
	6	Event Data 2 FFh = not specified
	7	Event Data 3 FFh = not specified
Response data	1	Completion Code

SDR Configuration	Value	Description
Assertion Event Mask	01h	Offset 0 can generate an assertion event
Deassertion Event Mask	00h	Sensor cannot generate deassertion events

POST Fail (Type 0Fh)

Table 4-14: POST Fail (Type 0Fh) Reading

	Offset	
Request data	1	Sensor Number
Response data	1	Completion Code
	2	Sensor Reading 00h – ignore on read
	3	Standard IPMI Byte. (See “Get Sensor Reading in the IPMI Specification)
	4	[7:1] – reserved, ignore on read [0] – 1b = System Firmware Error (POST Error)
	5	80h – ignore on read

Table 4-15: POST Fail (Type 0Fh) Event Message

	Offset	
Request data	1	Event Message Rev 04h
	2	Sensor Type 0Fh – System Firmware Progress (POST Error)
	3	Sensor Number
	4	[7] – Event Direction 1b = Deassertion 0b = Assertion [6-0] – Event Type 6Fh = sensor specific
	5	Event Data 1 [7:4] – 6h = OEM data in Event Data 2 and no data in Event Data 3 [3:0] – Offset 00h = System Firmware Error (POST Error) All other values are reserved.
	6	Event Data 2 Post Code (see)
	7	Event Data 3 unspecified
Response data	1	Completion Code

Boot Fail *(Sensor Type 1Eh)

Table 4-16: Boot Fail (Sensor Type 1Eh) Reading

	Offset	
Request data	1	Sensor Number
Response data	1	Completion Code
	2	Sensor Reading 00h – ignore on read
	3	Standard IPMI Byte. (See “Get Sensor Reading in the IPMI Specification)
	4	[7:4] – reserved, ignore on read [3] – 1b = permanent boot failure, no more images to try [2] – 1b = activation of backup image, boot failure detected [1] – 1b = network boot error [0] – 1b = local boot error while executing from flash
	5	80h – ignore on read

Table 4-17: Boot Fail (Sensor Type 1Eh) Event Message

	Offset	
Request data	1	Event Message Rev 04h
	2	Sensor Type 1Eh – Boot Error *
	3	Sensor Number
	4	[7] – Event Direction 1b = Deassertion 0b = Assertion [6-0] – Event Type 6Fh = sensor specific
	5	Event Data 1 [7:4] – 80h = OEM data in Event Data 2 and no data in Event Data 3 [3:0] – Offset 00h = local boot error while executing from flash 01h = network boot error 02h = activation of backup image, boot failure detected 03h = permanent boot failure, no more images to try All other values are reserved.
	6	Event Data 2 01h = failed image is image 1 00h = failed image is image 0
	7	Event Data 3 FFh = not specified
Response data	1	Completion Code

* Standard sensor type from IPMI2.0 defined for x86 systems.

4.4.2.3 Sensor Thresholds

Following tables show sensor thresholds for temperature, voltage and current sensors.

Table 4-18: Temperature Sensor Thresholds [°C]

SENSOR Number/ ID string	Lower critical	Lower non critical	Nominal	Upper non critical	Upper critical	Upper Non Recoverable
CP6924-RA-A						
Sxx:T_PCB				98°C	108°C	118°C
Sxx:T_PHY1				90°C	100°C	110°C
Sxx:T_PHY2				70°C	80°C	85°C
Sxx:T_PHY3				70°C	80°C	85°C

Table 4-19: Voltage Sensor Thresholds [V]

SENSOR Number / ID string	Lower critical	Lower non critical	Nominal	Upper non critical	Upper critical
Sxx:V_0V9_VTT	0.86V	0.882V	0,9V	0,918V	0.94V
Sxx:V_1V0	0.95V	0.98V	1.0V	1.02V	1.05V
Sxx:V_1V2	1.16V	1.176V	1.2V	1.224V	1.24V
Sxx:V_1V25	1.2V	1.225V	1.25V	1.275V	1.3V
Sxx:V_1V8	1.7V	1.764V	1.8V	1.872V	1.9V
Sxx:V_2V5	2.4V	2.45V	2.5V	2.55V	2.6V
Sxx:V_3V3	3.15V	3.175V	3.3V	3.43V	3.46V
Sxx:V_3V3_SUS	3.125V	3.175V	3.3V	3.432V	3.465V
Sxx:V_3V3_CPLD	3.0V	3.1V	3.3V	3.5V	3.6V
Sxx:V_3V3_CPCI	3.201V	3.234V	3.3V	3.432V	3.465V
Sxx:V_5V0_CPCI	4.85V	4.9V	5.0V	5.2V	5.25V
Sxx:V_5V0_IPMB	4.85V	4.9V	5.0V	5.2V	5.25V



Note...

LNR (Lower Non Recoverable), LNC (Lower Non Critical), UCR (Upper Non Critical) and UNR (Upper Non Recoverable) values and values marked n.a. are not defined.

Table 4-20: Current Sensor Thresholds [I]

SENSOR Number / ID string	Lower critical	Lower non critical	Nominal	Upper non critical	Upper critical
Sxx:I_3V3_CPCI	NA	NA	NA	5.25A	6.25A
Sxx:I_5V0_CPCI	NA	NA	NA	3.45A	4.00A

4.4.3 Board FRU Information

This FRU information contains the IPMI defined Board and Product Information areas that hold the part number and serial number of the board.

4.4.3.1 Structure And Functionality

The Management Controller provides 4 kB non-volatile storage space for FRU information.

Full low level access to read or write a module's FRU Information is provided by regular IPMI FRU Device commands. Please be careful when writing FRU information directly using standard IPMI commands because there is no write protection. Damaging the FRU Information e.g. may confuse a shelf management software which uses the FRU data.

4.4.3.2 Board Specific FRU Data

Supported are the following FRU data areas and data fields (shown values are examples, which may differ, depending on the used board typ):

FRU Board Info Area

- Manufacturing date / time
- Board manufacturer: "KONTRON "
- Board Product Name: " S1704"
- Board Serial Number : "0123456789" *)
- Board Part Number: "1055-1103"
- FRU File ID: "FRU-S1704-00"

FRU Product Info Area

- Product manufacturer: "Kontron"
- Product Name: "CP6924-RA-A"
- Product Version: "1055-2670"
- Product Serial Number: "0123456789" *)
- Asset Tag: "0000000000"
- FRU File ID : "FRU-S1704-00"

*) Shown values are examples.

Example

```
# ipmitool fru
FRU Device Description      : Builtin FRU Device (ID 0)
Board Manufacturing date   : Thu Sep 26 13:37:00 2013
Board Manufacturer        : Kontron
Board Product              : S1704
Board Serial               : 0400223034
Board Part Number         : 1055-1103
Product Manufacturer      : Kontron

Product Name               : CP6924-RA-OC
Product Part Number       : 1055-2670
Product Version           : 01
Product Serial            : 0400223034
Product Asset Tag         : 0000000000
```

4.5 Software Administration

A running CP6924-RA-A system requires – after the bootloader has passed control to the kernel – the kernel itself, the root file system (initrd), the FASTPATH switching application and the IPMI firmware.

The system supports an on-board integrated 1x128 MB NOR flash that is also used as the power-up boot source. It contains the bootloader as well as the operating system and the application data.

The onboard NOR flash is logically divided into two banks, where the first bank is used during normal system operation. This flash also contains a backup image that is used to recover the system if the boot image has been corrupted.

Table 4-21: On-board NOR FLASH Partition Scheme (128MB)

Physical Address	Offset in Flash	Size [kB]	Linux Partition	Designation	Description
F8000000	0	1024	mtd0	u-boot	Bootloader based on U-Boot
F8100000	100000	128	mtd1	vpd	Vital Product Data
		128			
F8140000	140000	128	mtd2	env	Redundant bootloader environment (each 128 KB)
		128			
F8180000	180000	43264	mtd3	system	Linux system (kernel and initrd multi image)
FABC0000	2BC0000	10240	mtd4	config	Read/Write Configuration data
FB5C0000	35C0000	10240	mtd5	profiles	Storage for extra profiles
FBFC0000	3FC0000	65280	mtd6	backup	Contains backup image. Copy of mtd0-5
FFF80000	7F80000	384	mtd7	reserved	Reserved area (temporarily used as upper half of production and bringup bootloader)
FFFE0000	7FE0000	128	mtd9	boot-fw	HW write protected boot firmware based on U-Boot



Note...

Note that only flash partition mtd4 is using the JFFS2 file system for storage. All other flash partitions are not formatted and accessible from linux only as raw devices.



Note...

The u-boot boot loader uses one flash sector for storing its environment variables. These can be saved and manipulated from the u-boot CLI and using linux tools. To enable atomic updates of the environment variables, u-boot uses redundant environment sectors; in case of a failure in completely writing the current sector (e.g. due to loss of power or reset during writes), it will automatically use the redundant environment. Therefore each boot monitor uses two flash sectors (partition mtd2) for storing its environment and redundant copy.

A complete software release for the CP6924-RA-A consists of the two files (example package-names):

- “CP6924-system-ipv6-BETA-1.00.pkg” or “CP6924-system-l2only-BETA-1.00.pkg” (depending on the board type)
- “CP6924-ipmi-BETA-1.00.hpm” (firmware package for the IPMI firmware)

In the following, the CLI commands to setup and copy System SW images and the CLI commands necessary to perform upgrades are described. As the commands are the very same for both system packages mentioned above, only the commands for the l2only version are described.

The CLI commands described below are executed in the privileged mode of the CLI hierarchy, which is entered by executing the ‘enable’ command. Please refer to the “CP6924-RA-A CLI Reference Manual” for more information regarding the CLI commands and the way to use them.

4.5.1 Updating System Software

The Software image is updated using the CLI. The following precautions are met to ensure a reliable and failsafe update procedure:

- Two independent system partitions, containing active system and backup system software. Active system is stored in flash mtd partitions mtd0-4, backup system is a verbatim copy of active system and is stored in flash partition mtd5 as a whole. This allows flash recovery from the redundant system in case that update fails due to power loss or similar errors.

The system update package (CP6924-system-l2onlyres-<release>.pkg) contains an image of bootloader, kernel, root filesystem as well as a MD5 checksum file for consistency check.

When performing an update, the software package is loaded from a remote TFTP server. A software update of the CP6924 is done by performing the following steps:

1. Copy the required file onto your tftp server. Rename the file to a shorter name (max. 31 characters):

```
root@tftp-serv:# mv CP6924-system-l2only-BETA-1.00.pkg CP6924-system-l2only.pkg
```

2. Log in to the privileged exec mode of the CLI of the CP6924-RA-A
3. Prepare network access of the system

```
(Ethernet Fabric) # serviceport protocol dhcp
```

4. Copy system image into the active image of the flash memory

```
(Ethernet Fabric) #copy tftp://192.168.50.154/CP6924-system-l2only.pkg active
(Ethernet Fabric) #
```

5. Check availability of valid boot image in active image using the command ‘show bootvar’

```
(Ethernet Fabric) #show bootvar
```

```
Image Descriptions
```

```
active : BETA-1.00          (20130927132743)
backup : BETA-1.00          (20130927132743)
```

```
Images currently available on Flash
```

```
-----
unit      active      backup      current-active      next-active
-----
1         1.0.0.0      1.0.0.0          1.0.0.0              1.0.0.0
```

```
Restart the system
```

```
(Ethernet Fabric) #reload
```

6. In case of problems with booting the system, last working backup image will automatically be copied to active image. This procedure restores normal system behavior. Configuration settings made with active image are lost and should be saved by copying active image to backup image before.
7. After verifying the correct operation, it is recommended to copy active image to backup image to have a fully redundant system

```
(Ethernet Fabric) #copy active backup
Copying active image to backup image
```

```
(Ethernet Fabric) #
```

The image will be copied including the configuration settings currently stored for active image.

4.5.2 Updating IPMI Firmware

Updating the IPMI firmware is done with the “copy” command. If the flash process is interrupted or fails, the IPMC will automatically recover using the previously installed image.

The IPMI firmware package file is provided in .pkg format and is stored in the data/update directory of the release directory tree.

```
(Ethernet Fabric) #copy tftp://192.168.50.5/CP6924-ipmi-GA-2.00.pkg ipmi
```

```
Flashing a new IPMI firmware will disable the IPMI Controller for some minutes.
Are you sure to update the IPMI firmware? (y/n)y
```

```
...
```

```
(Ethernet Fabric) #
```

5 Thermal Considerations

The CP6924 has four temperature sensors which ensure operation within the specified temperature limits. Sensor data is accessible via the Peripheral Manager. Although temperature sensing information is made available to the PM, the CP6924 itself does not provide any active means of temperature regulation.

As long as the temperature values stay below their upper critical threshold, all components on the CP6924 are considered to be operated within their specified temperature range.

Figure 5-1: Position of Temperature Sensors, Top Side View

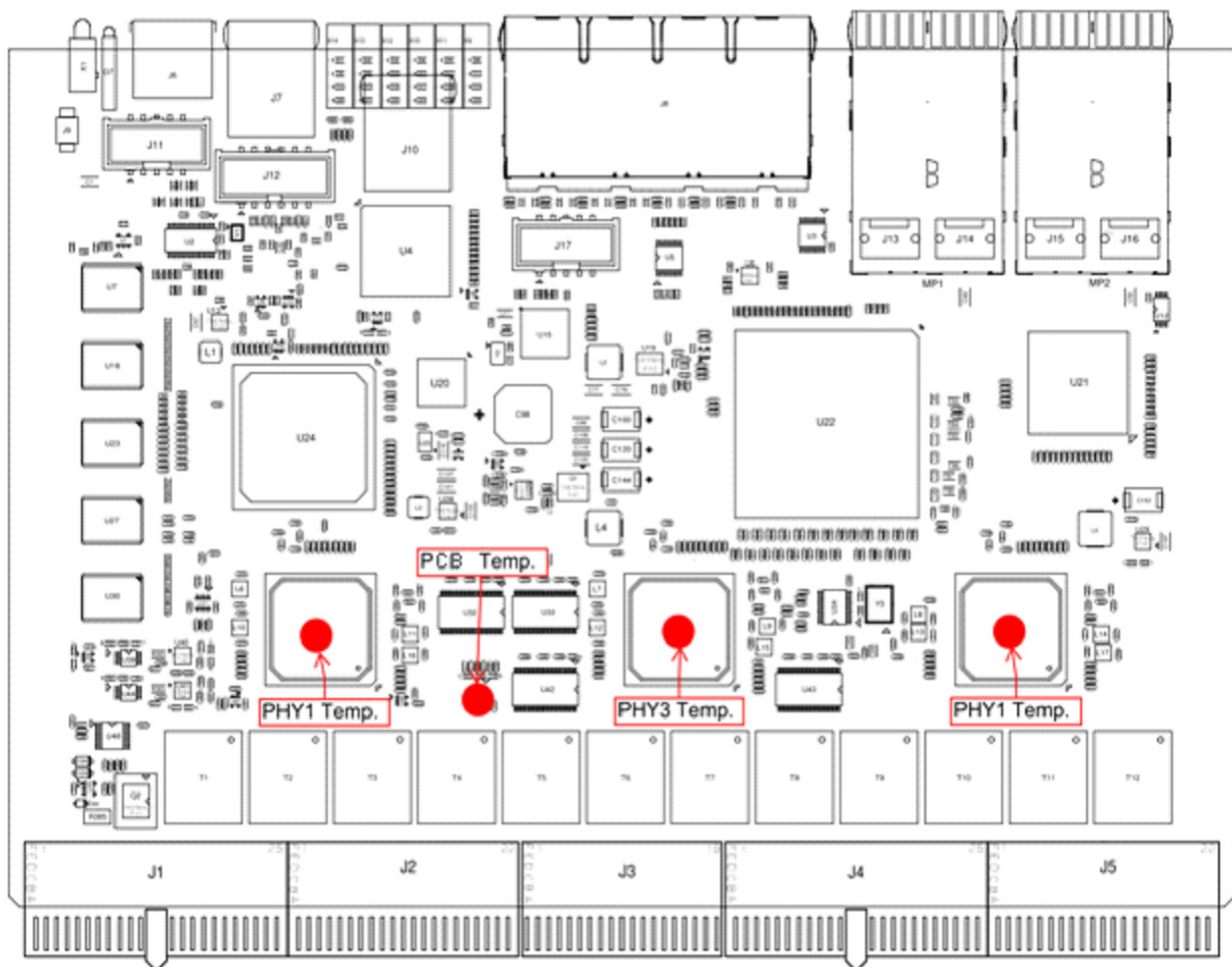

S02:T_PCB:TOP side of PCB close to Backplane connector J2

S03:T_PHY1:Temperature of PHY #1 (internal sensor)

S04:T_PHY2:Temperature of PHY #2 (internal sensor)

S05:T_PHY3:Temperature of PHY #3 (internal sensor)

When developing applications using the CP6924, the system integrator must be aware of the overall system thermal requirements. A system chassis must be provided which satisfy these requirements.

Measurements proofed that with forced air cooling of > 1.5 m/s, operation is possible under ambient temperature of $+85^{\circ}\text{C}$ and maximum load on all interfaces while all temperatures of on-board components stay below their critical thresholds.

**Note...**

The holdup time of the real time clock (all CP6924 versions) is up to 6 days, under moderate storage temperature conditions. It may decrease at lower or higher temperatures (aberration is not qualified).

**WARNING**

As Kontron assumes no responsibility for any damage to the CP6924 or other equipment resulting from overheating any of the components, it is highly recommended that system integrators as well as end users confirm that the operational environment of the CP6924 complies with the thermal considerations set forth in this document.

6 Power Considerations

The power considerations presented in this chapter must be taken into account by system integrators when specifying the CP6924 system environment.

6.1 Baseboard

The CP6924 has been designed for optimal power input and distribution. Still it is necessary to observe certain criteria essential for application stability and reliability. The board is supplied by 3.3V and 5.0V from the backplane. All supply voltages from the backplane are enabled with a predefined ramp-up time. The inrush current is limited by Hot-Swap controllers.

The table below indicates the absolute maximum input voltage ratings that must not be exceeded. Power supplies to be used with the CP6924 should be carefully tested to ensure compliance with these ratings.

Power consumption: below 50 W.

Table 6-1: Maximum Input Power Voltage Limits

Voltage Rail	Operation Mode	Maximum Current
V_3V3_CPCI	24x 1Gbps traffic rear 2x 1Gbps front SFP+ ports	6.25A
V_5V0_CPCI	24x 1Gbps traffic rear 2x 10Gbps front SFP+ ports	4.00A

5.0 V VIN +5%/-3%, designed for maximum load 8A (40W)

- 3.3V PoL Converter
- 1.25V PoL Converter
- 1.00V PoL Converter

3.3 V VIN +5%/-3%, designed for maximum load 10A (33W)

- 2.5V PoL Converter
- 1.8V PoL Converter
- 1.20V PoL Converter

6.2 Backplanes

Backplanes to be used with the CP6924 must be adequately specified. The backplane must provide optimal power distribution for the +3.3 V and +5 V power inputs. Input power connections to the backplane itself should be carefully specified to ensure a minimum of power loss and to guarantee operational stability. Long input lines, under-dimensioned cabling or bridges, high resistance connections, etc. must be avoided. It is recommended to use POSITRONIC or M-type connector backplanes and power supplies where possible.

CORPORATE OFFICES**Europe, Middle East & Africa**

Lise-Meitner-Straße 3-5
86156 Augsburg
Germany
Tel.: + 49 (0) 821 / 4086 01
Fax: + 49 (0) 821 / 4086 111
info@kontron.com

North America

14118 Stowe Drive
Poway, CA 92064-7147
USA
Tel.: + 1 888 294 4558
Fax: + 1 858 677 0898
info@us.kontron.com

Asia Pacific

17 Building, Block #1, ABP.
188 Southern West 4th Ring Road
Beijing 100070, P.R.China
Tel.: + 86 10 63751188
Fax: + 86 10 83682438
info@kontron.cn