



ECX-BSW

Doc. User Guide, Rev. 1.3

Doc. ID: [To be Determined]

This page has been intentionally left blank

 ECX-BSW - USER GUIDE

Disclaimer

Kontron would like to point out that the information contained in this user guide may be subject to alteration, particularly as a result of the constant upgrading of Kontron products. This document does not entail any guarantee on the part of Kontron with respect to technical processes described in the user guide or any product characteristics set out in the user guide. Kontron assumes no responsibility or liability for the use of the described product(s), conveys no license or title under any patent, copyright or mask work rights to these products and makes no representations or warranties that these products are free from patent, copyright or mask work right infringement unless otherwise specified. Applications that are described in this user guide are for illustration purposes only. Kontron makes no representation or warranty that such application will be suitable for the specified use without further testing or modification. Kontron expressly informs the user that this user guide only contains a general description of processes and instructions which may not be applicable in every individual case. In cases of doubt, please contact Kontron.

This user guide is protected by copyright. All rights are reserved by Kontron. No part of this document may be reproduced, transmitted, transcribed, stored in a retrieval system, or translated into any language or computer language, in any form or by any means (electronic, mechanical, photocopying, recording, or otherwise), without the express written permission of Kontron. Kontron points out that the information contained in this user guide is constantly being updated in line with the technical alterations and improvements made by Kontron to the products and thus this user guide only reflects the technical status of the products by Kontron at the time of publishing.

Brand and product names are trademarks or registered trademarks of their respective owners.

©2022 Kontron Europe GmbH

Kontron Europe GmbH

Gutenbergstraße 2
85737 Ismaning
Germany
www.kontron.com

High Risk Applications Hazard Notice

THIS DEVICE AND ASSOCIATED SOFTWARE ARE NOT DESIGNED, MANUFACTURED OR INTENDED FOR USE OR RESALE FOR THE OPERATION OF NUCLEAR FACILITIES, THE NAVIGATION, CONTROL OR COMMUNICATION SYSTEMS FOR AIRCRAFT OR OTHER TRANSPORTATION, AIR TRAFFIC CONTROL, LIFE SUPPORT OR LIFE SUSTAINING APPLICATIONS, WEAPONS SYSTEMS, OR ANY OTHER APPLICATION IN A HAZARDOUS ENVIRONMENT, OR REQUIRING FAIL-SAFE PERFORMANCE, OR IN WHICH THE FAILURE OF PRODUCTS COULD LEAD DIRECTLY TO DEATH, PERSONAL INJURY, OR SEVERE PHYSICAL OR ENVIRONMENTAL DAMAGE (COLLECTIVELY, "HIGH RISK APPLICATIONS").

You understand and agree that your use of Kontron devices as a component in High Risk Applications is entirely at your risk. To minimize the risks associated with your products and applications, you should provide adequate design and operating safeguards. You are solely responsible for compliance with all legal, regulatory, safety, and security related requirements concerning your products. You are responsible to ensure that your systems (and any Kontron hardware or software components incorporated in your systems) meet all applicable requirements. Unless otherwise stated in the product documentation, the Kontron device is not provided with error-tolerance capabilities and cannot therefore be deemed as being engineered, manufactured or setup to be compliant for implementation or for resale as device in High Risk Applications. All application and safety related information in this document (including application descriptions, suggested safety measures, suggested Kontron products, and other materials) is provided for reference only.

Revision History

Revision	Brief Description of Changes	Date of Issue
1.0	Initial Issue	2018-Sep-20
1.1	Add a LPS power supply notice in Sec. 2.1	2020-Apr-24
1.2	Audio codec chip replacement	2021-Apr-09
1.3	Modify USB 3.0 to USB 3.2 Gen 1 per new naming	2022-Jul-29

Terms and Conditions

Kontron warrants products in accordance with defined regional warranty periods. For more information about warranty compliance and conformity, and the warranty period in your region, visit <https://www.kontron.com/terms-and-conditions>.

Kontron sells products worldwide and declares regional General Terms & Conditions of Sale, and Purchase Order Terms & Conditions. Visit <https://www.kontron.com/terms-and-conditions>.

For contact information, refer to the corporate offices contact information on the last page of this user guide or visit our website [CONTACT US](#).

Customer Support

Find Kontron contacts by visiting: <https://www.kontron.com/support>.

Customer Service

As a trusted technology innovator and global solutions provider, Kontron extends its embedded market strengths into a services portfolio allowing companies to break the barriers of traditional product lifecycles. Proven product expertise coupled with collaborative and highly-experienced support enables Kontron to provide exceptional peace of mind to build and maintain successful products.

For more details on Kontron's service offerings such as: enhanced repair services, extended warranty, Kontron training academy, and more visit <https://www.kontron.com/support-and-services/services>.

Customer Comments

If you have any difficulties using this user guide, discover an error, or just want to provide some feedback, contact [Kontron support](#). Detail any errors you find. We will correct the errors or problems as soon as possible and post the revised user guide on our website.

Symbols

The following symbols may be used in this user guide

⚠ DANGER

DANGER indicates a hazardous situation which, if not avoided, will result in death or serious injury.

⚠ WARNING

WARNING indicates a hazardous situation which, if not avoided, could result in death or serious injury.

NOTICE

NOTICE indicates a property damage message.

⚠ CAUTION

CAUTION indicates a hazardous situation which, if not avoided, may result in minor or moderate injury.



Electric Shock!

This symbol and title warn of hazards due to electrical shocks (> 60 V) when touching products or parts of products. Failure to observe the precautions indicated and/or prescribed by the law may endanger your life/health and/or result in damage to your material.



ESD Sensitive Device!

This symbol and title inform that the electronic boards and their components are sensitive to static electricity. Care must therefore be taken during all handling operations and inspections of this product in order to ensure product integrity at all times.



HOT Surface!

Do NOT touch! Allow to cool before servicing.



Laser!

This symbol inform of the risk of exposure to laser beam and light emitting devices (LEDs) from an electrical device. Eye protection per manufacturer notice shall review before servicing.



This symbol indicates general information about the product and the user guide.

This symbol also indicates detail information about the specific product configuration.



This symbol precedes helpful hints and tips for daily use.

For Your Safety

Your new Kontron product was developed and tested carefully to provide all features necessary to ensure its compliance with electrical safety requirements. It was also designed for a long fault-free life. However, the life expectancy of your product can be drastically reduced by improper treatment during unpacking and installation. Therefore, in the interest of your own safety and of the correct operation of your new Kontron product, you are requested to conform with the following guidelines.

High Voltage Safety Instructions

As a precaution and in case of danger, the power connector must be easily accessible. The power connector is the product's main disconnect device.

⚠ CAUTION

Warning

All operations on this product must be carried out by sufficiently skilled personnel only.

⚠ CAUTION



Electric Shock!

Before installing a non hot-swappable Kontron product into a system always ensure that your mains power is switched off. This also applies to the installation of piggybacks. Serious electrical shock hazards can exist during all installation, repair, and maintenance operations on this product. Therefore, always unplug the power cable and any other cables which provide external voltages before performing any work on this product.

Earth ground connection to vehicle's chassis or a central grounding point shall remain connected. The earth ground cable shall be the last cable to be disconnected or the first cable to be connected when performing installation or removal procedures on this product.

Special Handling and Unpacking Instruction

NOTICE



ESD Sensitive Device!

Electronic boards and their components are sensitive to static electricity. Therefore, care must be taken during all handling operations and inspections of this product, in order to ensure product integrity at all times.

Do not handle this product out of its protective enclosure while it is not used for operational purposes unless it is otherwise protected.

Whenever possible, unpack or pack this product only at EOS/ESD safe work stations. Where a safe work station is not guaranteed, it is important for the user to be electrically discharged before touching the product with his/her hands or tools. This is most easily done by touching a metal part of your system housing.

It is particularly important to observe standard anti-static precautions when changing piggybacks, ROM devices, jumper settings etc. If the product contains batteries for RTC or memory backup, ensure that the product is not placed on conductive surfaces, including anti-static plastics or sponges. They can cause short circuits and damage the batteries or conductive circuits on the product.

Lithium Battery Precautions

If your product is equipped with a lithium battery, take the following precautions when replacing the battery.

CAUTION

Danger of explosion if the battery is replaced incorrectly.

- ▶ Replace only with same or equivalent battery type recommended by the manufacturer.
- ▶ Dispose of used batteries according to the manufacturer's instructions.

General Instructions on Usage

In order to maintain Kontron's product warranty, this product must not be altered or modified in any way. Changes or modifications to the product, that are not explicitly approved by Kontron and described in this user guide or received from Kontron Support as a special handling instruction, will void your warranty.

This product should only be installed in or connected to systems that fulfill all necessary technical and specific environmental requirements. This also applies to the operational temperature range of the specific board version that must not be exceeded. If batteries are present, their temperature restrictions must be taken into account.

In performing all necessary installation and application operations, only follow the instructions supplied by the present user guide.

Keep all the original packaging material for future storage or warranty shipments. If it is necessary to store or ship the product then re-pack it in the same manner as it was delivered.

Special care is necessary when handling or unpacking the product. See Special Handling and Unpacking Instruction.

Quality and Environmental Management

Kontron aims to deliver reliable high-end products designed and built for quality, and aims to complying with environmental laws, regulations, and other environmentally oriented requirements. For more information regarding Kontron's quality and environmental responsibilities, visit <https://www.kontron.com/about-kontron/corporate-responsibility/quality-management>.

Disposal and Recycling

Kontron's products are manufactured to satisfy environmental protection requirements where possible. Many of the components used are capable of being recycled. Final disposal of this product after its service life must be accomplished in accordance with applicable country, state, or local laws or regulations.

WEEE Compliance

The Waste Electrical and Electronic Equipment (WEEE) Directive aims to:

- ▶ Reduce waste arising from electrical and electronic equipment (EEE)
- ▶ Make producers of EEE responsible for the environmental impact of their products, especially when the product become waste
- ▶ Encourage separate collection and subsequent treatment, reuse, recovery, recycling and sound environmental disposal of EEE
- ▶ Improve the environmental performance of all those involved during the lifecycle of EEE



Environmental protection is a high priority with Kontron.

Kontron follows the WEEE directive

You are encouraged to return our products for proper disposal.

Table of Contents

Symbols	6
For Your Safety	7
High Voltage Safety Instructions	7
Special Handling and Unpacking Instruction	7
Lithium Battery Precautions	8
General Instructions on Usage	8
Quality and Environmental Management	8
Disposal and Recycling	8
WEEE Compliance	8
Table of Contents	9
List of Tables	10
List of Figures	11
1/ Introduction	13
2/ Installation Procedures	14
2.1. Installing the Board	14
2.2. Chassis Safety Standards	15
2.3. Lithium Battery Replacement	15
3/ System Specifications	17
3.1. System Block Diagram	17
3.2. Component Main Data	18
3.3. Environmental Conditions	19
3.4. Standards and Certifications	19
3.5. Processor Support	20
3.6. System Memory Support	20
3.6.1. Memory Operating Frequencies	20
3.7. On-board Graphics Subsystem	21
3.8. Power Supply	21
4/ Connector Locations	22
4.1. Top Side	22
4.2. Rear Side	24
4.3. Connector Panel Side	25
5/ Connector Definitions	26
6/ I/O-Area Connectors	27
6.1. HDMI Connector (CN18)	27
6.2. DP Connector (CN17)	28
6.3. Ethernet Connectors (CN13 & CN14)	29
6.4. USB Connectors (I/O Area)	30
7/ Internal Connectors	32
7.1. Power Connector	32
7.1.1. Power Input Wafer (CN1)	32
7.1.2. CR2032 Battery Power Input Wafer (BAT1)	32
7.2. DC 5V Fan Wafer (FAN1)	33
7.3. SATA (Serial ATA) Disk Interfaces (SATA1 & SATA2)	34
7.4. HDD Power Output Wafer (CN12)	35
7.5. USB Connectors (Internal) (CN10)	36
7.6. Speaker Connector (CN16 & CN19)	37

7.7. Audio Connector (CN15).....	37
7.8. Front Panel Pin Header (FP1 & FP2).....	38
7.9. Serial COM1 - COM6 Ports (CN20 - CN25).....	40
7.10. LVDS Panel Connector (CN3).....	41
7.11. Backlight Power Output Wafer (CN26).....	43
7.12. VGA Header (CN6).....	44
7.13. Digital Input / Output Wafer (CN11).....	45
7.14. mPCIe Slot Connector (MPCIE1 & MPCIE2).....	46
7.15. SIM Interface Wafer for MPCIE1 (CN7).....	51
7.16. PS/2 Keyboard and Mouse Wafer (CN4).....	52
7.17. Micro-SD Card Cage (CN2).....	53
7.18. mPCIe LED Activity Indicator Pin Header (JP3).....	54
7.19. Switches and Jumpers.....	55
7.19.1. RTC Reset Selection (JP1).....	55
7.19.2. Backlight Enable Selection (JP2).....	56
7.19.3. Panel & Backlight Power Selection (JP4).....	56
7.19.4. USB Power Selection (JP6).....	57
7.19.5. ME F/W Selection (JP7).....	57
7.19.6. Keyboard Lock Selection (JP8).....	57
7.19.7. AT / ATX Power Mode Selection (JP9).....	58
8/ BIOS.....	59
8.1. Starting the uEFI BIOS.....	59
8.2. Setup Menus.....	60
8.2.1. Main Setup Menu.....	60
8.2.2. Advanced Setup Menu.....	62
8.2.3. Power Setup Menu.....	76
8.2.4. Security Setup Menu.....	79
8.2.4.1. Remember the password.....	80
8.2.5. Boot Setup Menu.....	81
8.2.6. Save & Exit Setup Menu.....	82
Appendix A: List of Acronyms.....	83
About Kontron.....	84

List of Tables

Table 1: Component Main Data.....	18
Table 2: Environmental Conditions.....	19
Table 3: Standards and Certifications.....	19
Table 4: Processor Support.....	20
Table 5: Memory Operating Frequencies.....	20
Table 6: Triple-displays Configurations.....	21
Table 7: Supply Voltages.....	21
Table 8: Jumper List.....	22
Table 9: Top Side Internal Connector Pin Assignment.....	22
Table 10: Rear Side Internal Connector Pin Assignment.....	24
Table 11: Connector Panel Side Connector List.....	25
Table 12: Pin Assignment HDMI Connector CN18.....	27
Table 13: Pin Assignment DP Connector CN17.....	28
Table 14: Pin Assignment Ethernet Connectors CN13, CN14.....	29
Table 15: Pin Assignment USB 3.2 Gen 1 Connector CN8, CN9.....	30
Table 16: Signal Description.....	30

Table 17: Pin Assignment CN1	32
Table 18: Pin Assignment BAT1	32
Table 19: Pin Assignment FAN1	33
Table 20: Signal description	33
Table 21: Pin Assignment SATA1, SATA2	34
Table 22: Signal Description	34
Table 23: Pin Assignment CN12	35
Table 24: Pin Assignment CN10	36
Table 25: Signal Description	36
Table 26: Pin Assignment CN16, CN19	37
Table 27: Pin Assignment CN15	37
Table 28: Pin Assignment FP1	38
Table 29: Signal Description	38
Table 30: Pin Assignment FP2	39
Table 31: Signal Description	39
Table 32: Pin Assignment CN20, CN21	40
Table 33: Pin Assignment CN22 - CN25	40
Table 34: Signal Description	41
Table 35: Pin Assignment CN3	41
Table 36: Signal Description	42
Table 37: Pin Assignment CN26	43
Table 38: Signal Description	43
Table 39: Pin Assignment CN6	44
Table 40: Pin Assignment CN11	45
Table 41: Pin Assignment MPCIE1	46
Table 42: Pin Assignment MPCIE2	47
Table 43: Pin Assignment MPCIE2 (when replaced with mSATA socket)	49
Table 44: Pin Assignment CN7	51
Table 45: Pin Assignment CN4	52
Table 46: Signal Description	52
Table 47: Pin Assignment CN2	53
Table 48: Pin Assignment JP3	54
Table 49: Pin Assignment JP1	55
Table 50: Pin Assignment JP2	56
Table 51: Pin Assignment JP4	56
Table 52: Pin Assignment JP6	57
Table 53: Pin Assignment JP7	57
Table 54: Pin Assignment JP8	57
Table 55: Pin Assignment JP9	58
Table 56: Font Size Table	59
Table 57: Main Setup Menu Sub-Screens and Functions	60
Table 58: List of Acronyms	83

List of Figures

Figure 1: System Block Diagram ECX-BSW	17
Figure 2: Top Side	22
Figure 3: Rear Side	24
Figure 4: Connector Panel Side	25
Figure 5: HDMI Connector CN18	27
Figure 6: DP Connector CN17	28
Figure 7: Ethernet Connectors CN13, CN14	29
Figure 8: USB 3.2 Gen 1 Connector CN8, CN9	30
Figure 9: USB 2.0 High Speed Cable	30
Figure 10: USB 3.2 High Speed Cable	31
Figure 11: Power Input Wafer CN1	32

Figure 12: CR2032 Battery Power Input Wafer BAT1 32

Figure 13: DC5V Fan Wafer FAN1..... 33

Figure 14: SATA Connector SATA1, SATA2 34

Figure 15: HDD Power Output Wafer CN12 35

Figure 16: USB 2.0 Port 1, 2 Pin Header CN10..... 36

Figure 17: 3W Audio AMP Output Wafer CN16 (Left Channel), CN19 (Right Channel) 37

Figure 18: Audio Input / Output Pin Header CN15..... 37

Figure 19: Front Panel Pin Header FP1 38

Figure 20: Front Panel Pin Header FP2..... 38

Figure 21: Serial COM CN20 - CN25..... 40

Figure 22: LVDS Connector CN3 41

Figure 23: Backlight Power Output Wafer CN26 43

Figure 24: VGA Header CN6 44

Figure 25: Digital Input / Output Wafer CN11..... 45

Figure 26: mPCIe Slot Connector MPCIE1, MPCIE2 46

Figure 27: SIM Interface Wafer CN7 51

Figure 28: PS/2 Keyboard / Mouse Wafer CN4 52

Figure 29: Micro-SD Card Cage CN2 53

Figure 30: mPCIe LED Activity Indicator Pin Header JP3..... 54

Figure 31: Jumper Connector 55

Figure 32: RTC Reset Selection JP1..... 55

Figure 33: Backlight Enable Selection JP2..... 56

Figure 34: Panel & Backlight Power Selection JP4..... 56

Figure 35: USB Power Selection JP6 57

Figure 38: ME F/W Selection JP7 57

Figure 37: Keyboard Lock Selection JP8..... 57

Figure 38: AT / ATX Power Mode Selection JP9..... 58

Figure 39: BIOS Main Menu Screen System Data and Time 61

Figure 40: BIOS Advanced Menu..... 63

Figure 41: BIOS Advanced Menu - Display Configuration 64

Figure 42: BIOS Advanced Menu - Super IO Configuration..... 66

Figure 43: BIOS Advanced Menu - Super IO Configuration - Serial Port 1 Configuration 66

Figure 44: BIOS Advanced Menu - Super IO Configuration - Serial Port 2 Configuration 67

Figure 45: BIOS Advanced Menu - Super IO Configuration - Serial Port 3 Configuration..... 68

Figure 46: BIOS Advanced Menu - Super IO Configuration - Serial Port 4 Configuration 68

Figure 47: BIOS Advanced Menu - Super IO Configuration - Serial Port 5 Configuration..... 69

Figure 48: BIOS Advanced Menu - Super IO Configuration - Serial Port 6 Configuration 70

Figure 49: BIOS Advanced Menu - CPU Chipset Configuration 71

Figure 50: BIOS Advanced Menu - SATA Configuration 72

Figure 51: BIOS Advanced Menu - USB Configuration 73

Figure 52: BIOS Advanced Menu - DIO Configuration..... 74

Figure 53: BIOS Advanced Menu - H/W Monitor 75

Figure 54: BIOS Power Setup Menu 76

Figure 55: BIOS Power Setup Menu - WatchDog Timer Configuration..... 78

Figure 56: BIOS Boot Setup Menu..... 79

Figure 57: BIOS Boot Setup Menu 81

Figure 58: BIOS Boot Setup Menu 82

1/ Introduction

This user guide describes the ECX-BSW board made by Kontron. This board will also be denoted ECX-BSW within this user guide.

Use of this user guide implies a basic knowledge of PC-AT hardware and software. This user guide focuses on describing the ECX-BSW board's special features and is not intended to be a standard PC-AT textbook.

New users are recommended to study the short installation procedure stated in the following chapter before switching on the power.

All configuration and setup of the CPU board is either carried out automatically or manually by the user via the BIOS setup menus.

Latest revision of this user guide, datasheet, thermal simulations, BIOS, drivers, BSP's (Board Support Packages), mechanical drawings (2D and 3D) can be downloaded from Kontron's Web Page.

2/ Installation Procedures

2.1. Installing the Board

NOTICE



ESD Sensitive Device

Electrostatic discharge (ESD) can damage equipment and impair electrical circuitry.

- ▶ Wear ESD-protective clothing and shoes
- ▶ Wear an ESD-preventive wrist strap attached to a good earth ground
- ▶ Check the resistance value of the wrist strap periodically (1 MΩ to 10 MΩ)
- ▶ Transport and store the board in its antistatic bag
- ▶ Handle the board at an approved ESD workstation
- ▶ Handle the board only by the edges

To get the board running follow these steps. If the board shipped from KONTRON already has components like RAM and CPU cooler mounted, then skip the relevant steps below.

1. Turn off the PSU (Power Supply Unit)

NOTICE

Turn off PSU (Power Supply Unit) completely (no mains power connected to the PSU) or leave the Power Connectors unconnected while configuring the board. Otherwise, components (RAM, LAN cards etc.) might get damaged. Make sure to use +12 V DC single supply only. Alternatively, use a standard ATX PSU with suitable cable kit and PS-ON# active.

NOTICE

The power supply unit shall comply with the requirements as defined in IEC 62368-1 according Clause 6.2.2 to power source category PS2 "Limited Power Source".

2. Insert the DDR3L 1600 module

Be careful to push the memory module in the slot before locking the tabs.

3. Connecting interfaces

Insert all external cables for hard disk, keyboard etc. A monitor must be connected in order to change BIOS settings.

4. Connect and turn on PSU

Connect PSU to the board by the +12 V 3.0mm pitch 1x4-pin wafer connector.

5. BIOS setup

Enter the BIOS setup by pressing the key during boot up.

Enter "Exit Menu" and Load Setup Defaults.



To clear all BIOS setting, including Password protection, activate "Clear CMOS Jumper" for 10 sec (without power connected).

6. Mounting the board in chassis

NOTICE

When mounting the board to chassis etc. please note that the board contains components on both sides of the PCB that can easily be damaged if board is handled

without reasonable care. A damaged component can result in malfunction or no function at all.

When fixing the board on a chassis, it is recommended to use screws with an integrated washer and a diameter of > 7 mm. Do not use washers with teeth, as they can damage the PCB and cause short circuits.

2.2. Chassis Safety Standards

Before installing the ECX-BSW in the chassis, users must evaluate the end product to ensure compliance with the requirements of the IEC60950-1 safety standard:

- ▶ The board must be installed in a suitable mechanical, electrical and fire enclosure.
- ▶ The system, in its enclosure, must be evaluated for temperature and airflow considerations.
- ▶ The board must be powered by a CSA or UL approved power supply that limits the maximum input current.
- ▶ For interfaces having a power pin such as external power or fan, ensure that the connectors and wires are suitably rated. All connections from and to the product shall be with SELV circuits only.
- ▶ Wires have suitable rating to withstand the maximum available power.
- ▶ The peripheral device enclosure fulfils the IEC60950-1 fire protecting requirements.

2.3. Lithium Battery Replacement

If replacing the lithium battery follow the replacement precautions stated in the notification below:

⚠ CAUTION

Danger of explosion if the lithium battery is incorrectly replaced.

- ▶ Replace only with the same or equivalent type recommended by the manufacturer
- ▶ Dispose of used batteries according to the manufacturer's instructions

VORSICHT! Explosionsgefahr bei unsachgemäßem Austausch der Batterie.

- ▶ Ersatz nur durch denselben oder einen vom Hersteller empfohlenen gleichwertigen Typ
- ▶ Entsorgung gebrauchter Batterien nach Angaben des Herstellers

ATTENTION! Risque d'explosion avec l'échange inadéquat de la batterie.

- ▶ Remplacement seulement par le même ou un type équivalent recommandé par le producteur
- ▶ L'évacuation des batteries usagées conformément à des indications du fabricant

PRECAUCION! Peligro de explosi3n si la bater3a se sustituye incorrectamente.

- ▶ Sustituya solamente por el mismo o tipo equivalente recomendado por el fabricante
- ▶ Disponga las bater3as usadas seg3n las instrucciones del fabricante

ADVARSEL! Lithiumbatteri – Explosionsfare ved fejlagtig h3ndtering.

- ▶ Udsiftning m3 kun ske med batteri af samme fabrikat og type
- ▶ Lev3r det brugte batteri tilbage til leverand3ren

ADVARSEL! Eksplosjonsfare ved feilaktig skifte av batteri.

- ▶ Benytt samme batteritype eller en tilsvarende type anbefalt av apparatfabrikanten
- ▶ Brukte batterier kasseres i henhold til fabrikantens instruksjoner

WARNING! Explosionsfara vid felaktigt batteribyte.

- ▶ Anv3nd samma batterityp eller en ekvivalent typ som rekommenderas av apparattillverkaren
 - ▶ Kassera anv3nt batteri enligt fabrikantens instruktion
-

VAROITUS! Paristo voi räjähtää, jos se on virheellisesti asennettu.

- ▶ Vaihda paristo ainoastaan valmistajan suosittelemaan tyyppiin
 - ▶ Hävitä käytetty paristo valmistajan ohjeiden mukaisesti
-

3/ System Specifications

3.1. System Block Diagram

Figure 1: System Block Diagram ECX-BSW

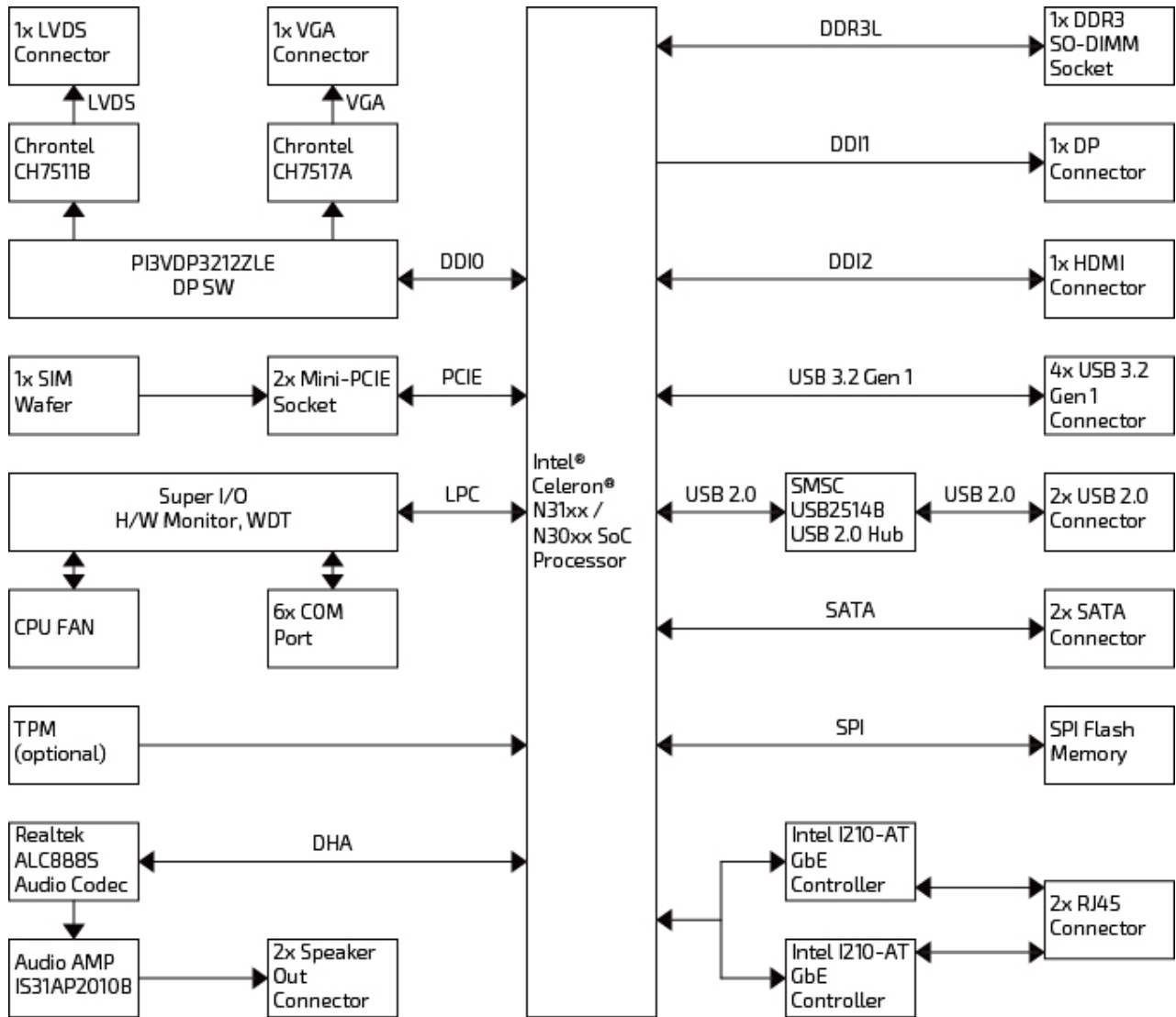

3.2. Component Main Data

The table below summarizes the features of the ECX-BSW single board computer.

Table 1: Component Main Data

System													
Processor	▶ Intel® Celeron® N31xx / N30xx SoC Processors												
Memory	▶ 1x DDR3L SO-DIMM memory socket												
Video													
Display Interface	▶ 1x LVDS (24-bit, 2-ch) ▶ 1x DP (on rear) ▶ 1x HDMI (on rear) ▶ 1x VGA (by header)												
Audio													
Audio Codec	▶ Realtek ALC888S												
Audio Interface	▶ 1x Speaker-out (Stereo, 3 W, by header) ▶ 1x Line-in (by header) ▶ 1x Line-out (by header) ▶ 1x Mic-in (by header)												
Network Connection													
Ethernet	▶ 2x GbE LAN (RJ45 on rear, Intel® I210-AT)												
Peripheral Connection													
USB	▶ 4x USB 3.2 Gen 1 (Type A on rear) ▶ 2x USB 2.0 (by header)												
Serial Port	▶ 2x RS232/422/485 (by header) ▶ 4x RS232 (by header)												
Other I/Os	▶ 8x DIO (by header)												
Storage & Expansion													
Storage & Expansion	<table border="0"> <thead> <tr> <th>Configuration 1</th> <th>Configuration 2</th> </tr> </thead> <tbody> <tr> <td>▶ 2x SATA 3.0</td> <td>▶ 1x SATA 3.0</td> </tr> <tr> <td>▶ 1x Micro SD Crad Cage</td> <td>▶ 1x mSATA (full size)</td> </tr> <tr> <td>▶ 2x mPCIe (1x full size, 1x half size)</td> <td>▶ 1x Micro SD Crad Cage</td> </tr> <tr> <td>▶ 1x SIM Card Cage (by wafer)</td> <td>▶ 1x mPCIe (full size)</td> </tr> <tr> <td></td> <td>▶ 1x SIM Card Cage (by wafer)</td> </tr> </tbody> </table>	Configuration 1	Configuration 2	▶ 2x SATA 3.0	▶ 1x SATA 3.0	▶ 1x Micro SD Crad Cage	▶ 1x mSATA (full size)	▶ 2x mPCIe (1x full size, 1x half size)	▶ 1x Micro SD Crad Cage	▶ 1x SIM Card Cage (by wafer)	▶ 1x mPCIe (full size)		▶ 1x SIM Card Cage (by wafer)
Configuration 1	Configuration 2												
▶ 2x SATA 3.0	▶ 1x SATA 3.0												
▶ 1x Micro SD Crad Cage	▶ 1x mSATA (full size)												
▶ 2x mPCIe (1x full size, 1x half size)	▶ 1x Micro SD Crad Cage												
▶ 1x SIM Card Cage (by wafer)	▶ 1x mPCIe (full size)												
	▶ 1x SIM Card Cage (by wafer)												
Power													
Input Voltage	▶ DC 12 V												
Connector	▶ 1x4-pin Lockable Wafer												
Firmware													
BIOS	▶ AMI uEFI BIOS w/ 64 Mb SPI Flash												
Watchdog	▶ Programmable WDT to generate system reset event												
H/W Monitor	▶ Voltages, Temperatures												

Real Time Clock	▶ SoC integrated RTC
Security	▶ TPM 1.2 (Optional, Infineon SLB 9635)
System Control & Monitoring	
FP Header	▶ 1x Header for Reset Button, HDD LED & External Speaker ▶ 1x Header for Power Button, Power LED & SM bus ▶ 1x Header for mPCIe Activity LED
Cooling	
FAN	▶ 1x Wafer for CPU Smart Fan
Software	
OS Support	▶ Windows 7, Windows 8, Windows 10, Linux
Mechanical	
Dimension (L x W)	▶ 3.5" ECX (146 x 105 mm / 5.75" x 4.13")

3.3. Environmental Conditions

The ECX-BSW is compliant with the following environmental conditions. It is the customer's responsibility to provide sufficient airflow around each of the components to keep them within the allowed temperature range.

Table 2: Environmental Conditions

Operating Temperature	0 °C ~ 60 °C / 32 °F ~ 140 °F (Standard) -20 °C ~ 70 °C / -4 °F ~ 158 °F (Extended)
Storage Temperature	-20 °C ~ 80 °C / -4 °F ~ 176 °F (Standard) -40 °C ~ 85 °C / -40 °F ~ 185 °F (Extended)
Humidity	0 % ~ 95 %

3.4. Standards and Certifications

The ECX-BSW meets the following standards and certification tests.

Table 3: Standards and Certifications

CE Class A	▶ EN 55032: 2015 + AC: 2016, CISPR 32: 2015 + COR1: 2016 ▶ AS/NZS CISPR 32: 2015 ▶ EN 61000-3-2: 2014, IEC 61000-3-2: 2014 ▶ EN 61000-3-3: 2013, IEC 61000-3-3: 2013 ▶ EN 55024: 2010 + A1: 2015, CISPR 24: 2010 + A1: 2015 ▶ EN 61000-4-2: 2009, IEC 61000-4-2: 2008 ▶ EN 61000-4-3: 2006 + A1: 2008 + A2: 2010, IEC 61000-4-3: 2006 + A1: 2007, + A2: 2010 ▶ EN 61000-4-4: 2012, IEC 61000-4-4: 2012 ▶ EN 61000-4-5: 2014, IEC 61000-4-5: 2014 ▶ EN 61000-4-6: 2014 + AC: 2015, IEC 61000-4-6: 2013 ▶ EN 61000-4-8: 2010, IEC 61000-4-8: 2009
-------------------	-------------------------------------------------------------------------------------------------------------------------------------------------------------------------------------------------------------------------------------------------------------------------------------------------------------------------------------------------------------------------------------------------------------------------------------------------------------------------------------------------------------------------------------------------------------------------------

	▶ EN 61000-4-11: 2004, IEC 61000-4-11: 2004
FCC Class A	▶ FCC CFR Title 47 Part 15 Subpart B: 2015 - Section 15.107 and 15.109
	▶ ANSI C63.4-2014
	▶ ICES-003 Issue 6: 2016
	▶ Class A

3.5. Processor Support

The ECX-BSW is designed to support Intel® Celeron® N31xx / N30xx SoC Processors. The BGA CPU is pre-mounted from factory. Kontron has defined the board versions as listed in the following table, so far all based on Embedded CPUs. Other versions are expected at a later date.

Table 4: Processor Support

Name	Core #	Speed	Turbo	Embedded	Cache	Socket	TDP	Tj
Celeron® N3160	4	1.60 GHz	2.24 GHz	Yes	2M	FCBGA1170	6 W	90 °C
Celeron® N3060	2	1.60 GHz	2.48 GHz	Yes	2M	FCBGA1170	6 W	90 °C

Sufficient cooling must be applied to the CPU in order to remove the effect as listed as TDP (Thermal Design Power) in above table. The sufficient cooling is also depending on the worst case maximum ambient operating temperature and the actual worst case load of processor.

3.6. System Memory Support

The ECX-BSW has one DDR3L SO-DIMM socket. The sockets support the following memory features:

- ▶ 1x DDR3L SO-DIMM 204-pin
- ▶ Up to 8 GB
- ▶ SPD timing supported
- ▶ ECC not supported

The installed DDR3L SO-DIMM should support the Serial Presence Detect (SPD) data structure. This allows the BIOS to read and configure the memory controller for optimal performance. If non-SPD memory is used, the BIOS will attempt to configure the memory settings, but performance and reliability may be impacted, or the board may not be able to boot totally.

3.6.1. Memory Operating Frequencies

In all modes, the frequency of system memory is the lowest frequency of all the memory modules placed in the system. Each memory module's frequency can be determined through the SPD registers on the memory modules.

The table below lists the resulting operating memory frequencies based on the combination of SO-DIMMs and processor.

Table 5: Memory Operating Frequencies

SO-DIMM Type	Module Name	Memory Data Transfer (MT/s)	Processor System Bus Frequency (MHz)	Resulting Memory Clock Frequency (MHz)	Peak Transfer Rate (MB/s)
--------------	-------------	-----------------------------	--------------------------------------	----------------------------------------	---------------------------

SO-DIMM Type	Module Name	Memory Data Transfer (MT/s)	Processor System Bus Frequency (MHz)	Resulting Memory Clock Frequency (MHz)	Peak Transfer Rate (MB/s)
DDR3L 1600	PC3-12800	1600	800	200	12800

Memory modules have in general a much lower longevity than embedded motherboards, and therefore EOL of modules can be expected several times during lifetime of the motherboard.

As a minimum it is recommend using Kontron memory modules for prototype system(s) in order to prove stability of the system and as for reference.

For volume production you might request to test and qualify other types of RAM. In order to qualify RAM it is recommend configuring 3 systems running RAM Stress Test program in heat chamber at 60° C for a minimum of 24 hours.

3.7. On-board Graphics Subsystem

The ECX-BSW supports Intel® HD Graphics technology for high quality graphics capabilities. All ECX-BSW versions support triple displays pipes.

Up to triple displays can be used simultaneously and be used to implement independent or cloned display configuration.

Table 6: Triple-displays Configurations

Display 1	Display 2	Display	Max. Resolution (Px) at 60 Hz		
			Display 1	Display 2	Display
LVDS	DP	HDMI	1920x1200	2560x1600	2560x1600
VGA	DP	HDMI	1920x1200	2560x1600	2560x1600

3.8. Power Supply

In order to ensure safe operation of the board, the input power supply must monitor the supply voltage and shut down if the supply is out of range – refer to the actual power supply specification. Please note, in order to keep the power consumption to a minimal level, boards do not implement a guaranteed minimum load. In some cases, this can lead to compatibility problems with ATX power supplies that require a minimum load to stay in regulation. The ECX-BSW board must be powered through the ATX+12V-4p (4-pole) connector using standard ATX power supply.

ATX12V supply: ATX+12V-4p connector must be used in according to the ATX12V PSU standard.

NOTICE

Hot Plugging power supply is not supported. Hot plugging might damage the board.

The requirements to the supply voltages are as follows:

Table 7: Supply Voltages

Supply	Min.	Max.	Note
+12 V	11.4 V	12.6 V	Should be ±5% for compliance with the ATX specification

4/ Connector Locations

4.1. Top Side

Figure 2: Top Side

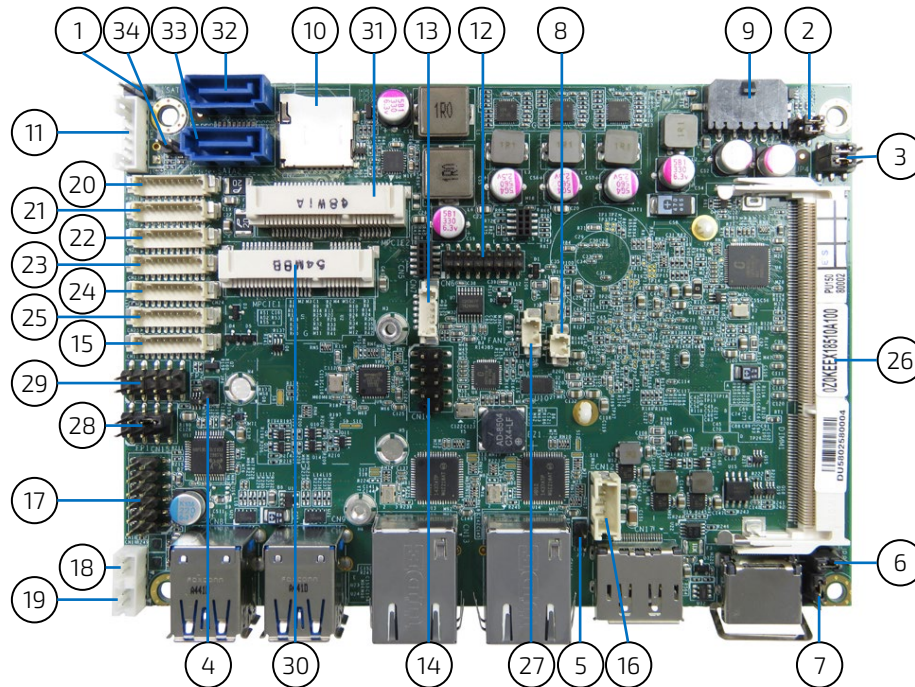

Table 8: Jumper List

Item	Designation	Description	See Chapter
1	JP1	RTC Reset Selection	7.19.
2	JP2	Backlight Enable Selection	7.19.
3	JP4	Panel & Backlight Power Selection	7.19.
4	JP6	USB Power Selection	7.19.
5	JP7	ME F/W Selection	7.19.
6	JP8	Keyboard Lock Selection	7.19.
7	JP9	AT / ATX Power Mode Selection	7.19.

Table 9: Top Side Internal Connector Pin Assignment

Item	Designation	Description	See Chapter
8	BAT1	CR2032 Battery Power Input Wafer	7.1.2
9	CN1	DC 12V Power Input Wafer	7.1.1
10	CN2	Micro-SD Card Cage	7.17
11	CN4	PS/2 Keyboard / Mouse Wafer	7.16
12	CN6	VGA Header	7.12
13	CN7	SIM Interface Wafer for MPCIE1	7.15
14	CN10	USB 2.0 Port DN_1, DN_2 Pin Header	7.5
15	CN11	Digital Input / Output Wafer	7.13
16	CN12	HDD Power Output Wafer	7.4

Item	Designation	Description	See Chapter
17	CN15	Audio Input / Output Pin Header	7.7
18	CN16	Left Channel 3W Audio AMP Output Wafer	7.6
19	CN19	Right Channel 3W Audio AMP Output Wafer	7.6
20	CN20	COM1 RS-232/422/485 Port Wafer	7.9
21	CN21	COM2 RS-232/422/485 Port Wafer	7.9
22	CN22	RS-232 Port 3 Wafer	7.9
23	CN23	RS-232 Port 4 Wafer	7.9
24	CN24	RS-232 Port 5 Wafer	7.9
25	CN25	RS-232 Port 6 Wafer	7.9
26	DIMM1	DDR3 Memory SO-DIMM Socket	3.6
27	FAN1	DC5V FAN Wafer	7.2
28	FP1	Front Panel 1 Pin Header	7.8
29	FP2	Front Panel 2 Pin Header	7.8
30	MPCIE1	Mini-PCI Express v1.2 Socket (Full Size)	7.14
31	MPCIE2	Mini-PCI Express v1.2 Socket (Half Size)	7.14
32	SATA1	Serial ATA Port 0 Connector	7.3
33	SATA2	Serial ATA Port 1 Connector	7.3
34	JP3	MPCIE Activity LED Indicator Pin Header	7.18

4.2. Rear Side

Figure 3: Rear Side

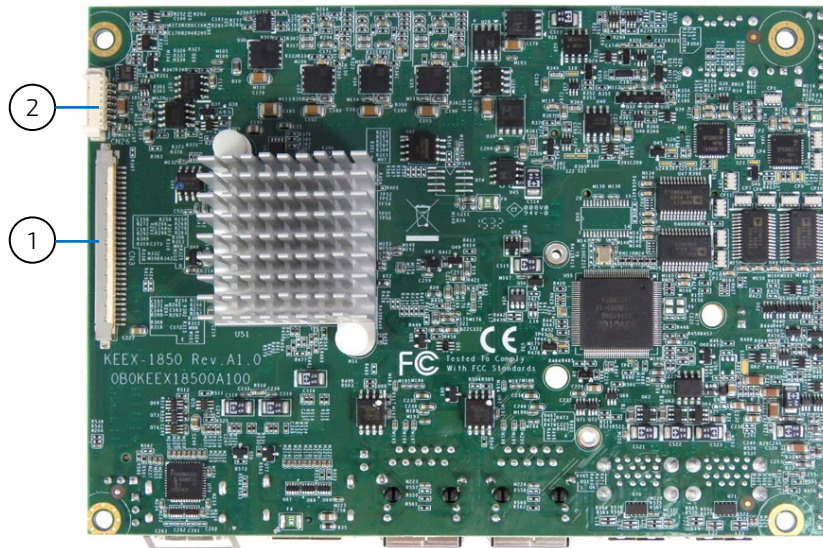

Table 10: Rear Side Internal Connector Pin Assignment

Item	Designation	Description	See Chapter
1	CN3	18/24-bit, Single Channel LVDS Panel Connector	7.10
2	CN26	Backlight Power Output Wafer	7.11

4.3. Connector Panel Side

Figure 4: Connector Panel Side

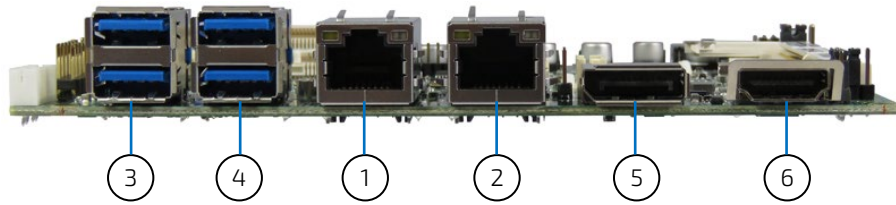

Table 11: Connector Panel Side Connector List

Item	Designation	Description	See Chapter
1	CN13	GbE LAN1 RJ-45 Connector	6.3
2	CN14	GbE LAN2 RJ-45 Connector	6.3
3	CN8	USB 3.2 Gen 1 Port 1,2 Type-A Connector	6.4
4	CN9	USB 3.2 Gen 1 Port 3,4 Type-A Connector	6.4
5	CN17	DP Connector	6.2
6	CN18	HDMI Connector	6.1

5/ Connector Definitions

The following defined terms are used within this user guide to give more information concerning the pin assignment and to describe the connector's signals.

Defined Term	Description
Pin	Shows the pin numbers in the connector
Signal	The abbreviated name of the signal at the current pin The notation "XX#" states that the signal "XX" is active low
Note	Special remarks concerning the signal
Designation	Type and number of item described
See Chapter	Number of the chapter within this user guide containing a detailed description

The abbreviation TBD is used for specifications that are not available yet or which are not sufficiently specified by the component vendors.

6/ I/O-Area Connectors

6.1. HDMI Connector (CN18)

The HDMI connector is based on standard HDMI type A.

Figure 5: HDMI Connector CN18

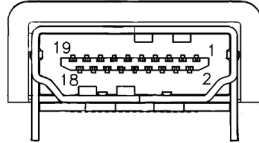

Table 12: Pin Assignment HDMI Connector CN18

Pin	Signal	Description	Note
1	TMDS Data2+		
2	Ground		
3	TMDS Data2-		
4	TMDS Data1+		
5	Ground		
6	TMDS Data1-		
7	TMDS Data0+		
8	Ground		
9	TMDS Data0-		
10	TMDS Clock+		
11	Ground		
12	TMDS Clock-		
13	Reserved		
14	Reserved		
15	DDC_CLK		
16	DDC_DATA		
17	Ground		
18	+5 V Power		
19	Hot Plug Detect		

6.2. DP Connector (CN17)

The DP (DisplayPort) connector is based on standard DP female port.

Figure 6: DP Connector CN17

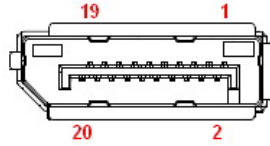

Table 13: Pin Assignment DP Connector CN17

Pin	Signal	Description	Note
1	TX0+		
2	GND		
3	TX0-		
4	TX1+		
5	GND		
6	TX1-		
7	TX2+		
8	GND		
9	TX2-		
10	TX3+		
11	GND		
12	TX3-		
13	GND		
14	GND		
15	AUX+		
16	GND		
17	AUX-		
18	HPD		
19	GND		
20	PWR		

6.3. Ethernet Connectors (CN13 & CN14)

The ECX-BSW supports two channels of 10/100/1000 Mbit Ethernet, which are based Intel® I210-AT controller.

In order to achieve the specified performance of the Ethernet port, Category 5 twisted pair cables must be used with 10/100 MByte and Category 5E, 6 or 6E with 1 Gbit LAN networks.

The signals for the Ethernet ports are as follows:

Figure 7: Ethernet Connectors CN13, CN14

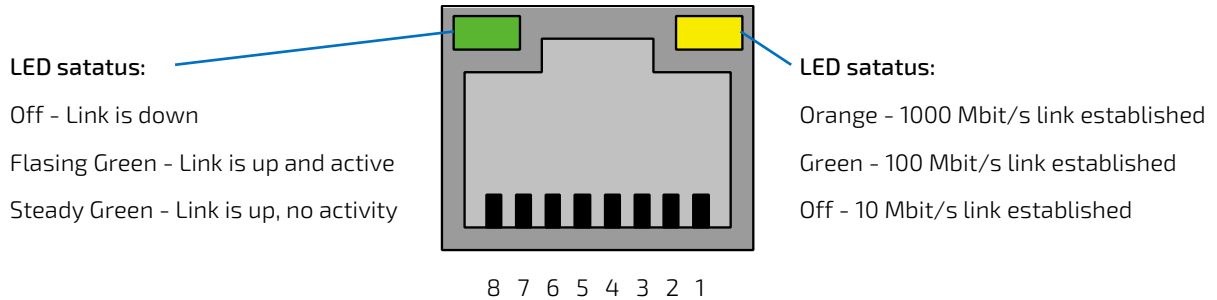

Table 14: Pin Assignment Ethernet Connectors CN13, CN14

Pin	Signal	Note
1	TX1+	
2	TX1-	
3	TX2+	
4	TX3+	
5	TX3-	
6	TX2-	
7	TX4+	
8	TX4-	

Signal Description

Signal	Description
TX1+ / TX1-	In MDI mode, this is the first pair in 1000Base-T, i.e. the BI_DA+/- pair, and is the transmit pair in 10Base-T and 100Base-TX. In MDI crossover mode, this pair acts as the BI_DB+/- pair, and is the receive pair in 10Base-T and 100Base-TX.
TX2+ / TX2-	In MDI mode, this is the second pair in 1000Base-T, i.e. the BI_DB+/- pair, and is the receive pair in 10Base-T and 100Base-TX. In MDI crossover mode, this pair acts as the BI_DA+/- pair, and is the transmit pair in 10Base-T and 100Base-TX.
TX3+ / TX3-	In MDI mode, this is the third pair in 1000Base-T, i.e. the BI_DC+/- pair. In MDI crossover mode, this pair acts as the BI_DD+/- pair.
TX4+ / TX4-	In MDI mode, this is the fourth pair in 1000Base-T, i.e. the BI_DD+/- pair. In MDI crossover mode, this pair acts as the BI_DC+/- pair.

'MDI' – media dependent Interface

6.4. USB Connectors (I/O Area)

The external I/O connector panel supports two dual USB 3.2 Gen 1 connectors.



USB 3.2 Gen 1 ports are backward compatible with USB 2.0.

Figure 8: USB 3.2 Gen 1 Connector CN8, CN9

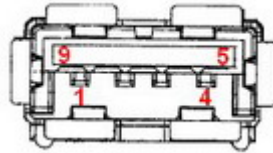

Table 15: Pin Assignment USB 3.2 Gen 1 Connector CN8, CN9

Pin	Signal	Note
1	+USB_VCC*	+5 V Supply for USB device
2	USB_D-	USB 2.0 Differential Pair (-)
3	USB_D+	USB 2.0 Differential Pair (+)
4	GND	
5	USB_RX-	USB 3.2 Gen 1 Rx. Differential Pair (-)
6	USB_RX+	USB 3.2 Gen 1 Rx. Differential Pair (+)
7	GND	
8	USB_TX-	USB 3.2 Gen 1 Tx. Differential Pair (-)
9	USB_TX+	USB 3.2 Gen 1 Tx. Differential Pair (+)



* The power source of +USB_VCC can be selected by JP6.

Table 16: Signal Description

Signal	Description
USB_TX+, USB_TX-, USB_RX+, USB_RX-, USB_D+, USB_D-	Differential pair works as serial differential receive/transmit data lines.
+USB_VCC	5 V supply for external devices. VCC is supplied during power-down to allow wakeup on USB device activity. Protected by a 1A current limiting IC covering each of the USB port.

For HiSpeed rates it is required to use a USB cable, which is specified in USB 2.0 standard:

Figure 9: USB 2.0 High Speed Cable

Polyvinyl Chloride (PVC) Jacket

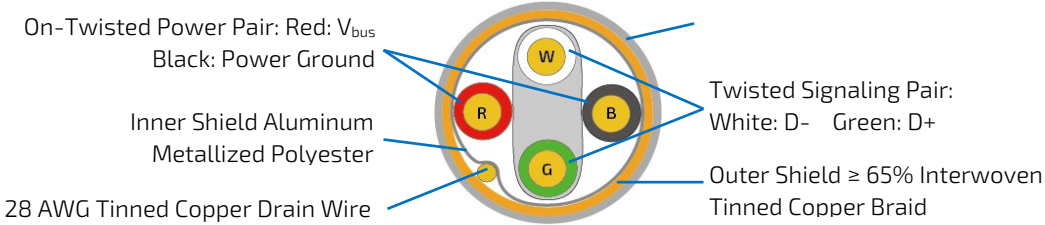

For USB 3.2 Gen 1 cabling it is required to use only HiSpeed USB cable, specified in USB 3.2 standard:

Figure 10: USB 3.2 High Speed Cable

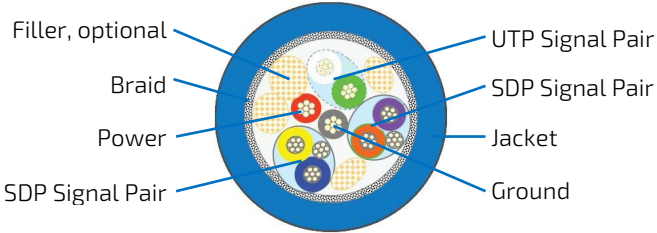

7/ Internal Connectors

7.1. Power Connector

Power connector must be used to supply the board with +12 VDC ($\pm 10\%$).

NOTICE

Hot plugging any of the power connector is not allowed.

Hot plugging might damage the board. In other words, turn off main supply etc. to make sure all the power lines are turned off when connecting to the motherboard.

7.1.1. Power Input Wafer (CN1)

Figure 11: Power Input Wafer CN1

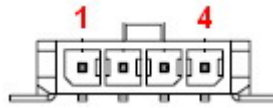

Table 17: Pin Assignment CN1

Pin	Signal	Description
1	+12Vin	Power +12 V
2	GND	Ground
3	GND	Ground
4	+12Vin	Power +12 V

7.1.2. CR2032 Battery Power Input Wafer (BAT1)

Figure 12: CR2032 Battery Power Input Wafer BAT1



Table 18: Pin Assignment BAT1

Pin	Signal	Description
1	Battery+	
2	Battery-	

7.2. DC 5V Fan Wafer (FAN1)

The CPU FAN Wafer (FAN1) is used for the connection of the FAN for the CPU.

Figure 13: DC5V Fan Wafer FAN1

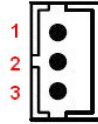

Table 19: Pin Assignment FAN1

Pin	Signal	Description
1	SENSE	Sense signal
2	+5V	Power +5 V
3	GND	Ground

Table 20: Signal description

Signal	Description
GND	Power Supply GND signal
5 V	+5 V supply for fan
SENSE	Sense input signal from the fan, for rotation speed supervision RPM (Rotations Per Minute). The signal shall be generated by an open collector transistor or similar.

7.3. SATA (Serial ATA) Disk Interfaces (SATA1 & SATA2)

The SATA connector supplies the data connection for the SATA hard disk and is SATA 3.0 compatible.

The board has two configurations: one supports one SATA socket while the other supports two sockets.

Figure 14: SATA Connector SATA1, SATA2

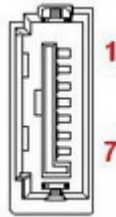

Table 21: Pin Assignment SATA1, SATA2

Pin	Signal	Note
1	GND	
2	TX+	
3	TX-	
4	GND	
5	RX-	
6	RX+	
7	GND	

Table 22: Signal Description

Signal	Description
RX+ / RX-	Host transmitter differential signal pair
TX+ / TX-	Host receiver differential signal pair

7.4. HDD Power Output Wafer (CN12)

Figure 15: HDD Power Output Wafer CN12



Table 23: Pin Assignment CN12

Pin	Signal	Note
1	+12V	
2	GND	
3	GND	
4	+5V	

7.5. USB Connectors (Internal) (CN10)

The USB connector (CN10) support two USB 2.0 ports.

Figure 16: USB 2.0 Port 1, 2 Pin Header CN10

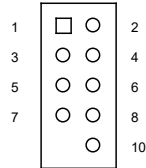

Table 24: Pin Assignment CN10

Pin	Signal	Note
1	+USBVCC	
2	+USBVCC	
3	USB_A-	
4	USB_B-	
5	USB_A+	
6	USB_B+	
7	GND	
8	GND	
9	KEY	
10	GND	



* The power source of +USBVCC can be selected by JP6.

Table 25: Signal Description

Signal	Description
+USBVCC	5 V supply for external devices. SB5V is supplied during power down to allow wakeup on USB device activity. Protected by active power switch 1 A fuse for each USB port.
USB_A-/+ USB_B-/+	Universal Serial Bus Differentials: Bus Data / Address / Command Bus.

7.6. Speaker Connector (CN16 & CN19)

The Speaker audio-out interface is available through the wafers CN16 and CN19. These outputs are shared with the audio output (Line-out) signals of the audio pin header CN15.

Figure 17: 3W Audio AMP Output Wafer CN16 (Left Channel), CN19 (Right Channel)

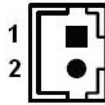

Table 26: Pin Assignment CN16, CN19

Pin	Signal	Note
1	Speaker+	
2	Speaker-	

7.7. Audio Connector (CN15)

The audio connector provides audio output (Line-Out), audio input (Line-In) and microphone (Mic-In) signals through the wafer CN15. The audio output signals are shared with those of the speaker connectors CN16 & CN19.

Figure 18: Audio Input / Output Pin Header CN15

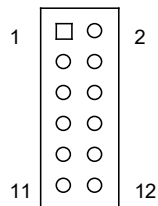

Table 27: Pin Assignment CN15

Pin	Signal	Note
1	MIC-In_L	
2	MIC-In_R	
3	MIC-In_JD#	
4	GND	
5	Line-In_L	
6	Line-In_R	
7	Line-In_JD#	
8	GND	
9	Line-Out_L	
10	Line-Out_R	
11	Line-Out_JD#	

Pin	Signal	Note
12	GND	

7.8. Front Panel Pin Header (FP1 & FP2)

Figure 19: Front Panel Pin Header FP1

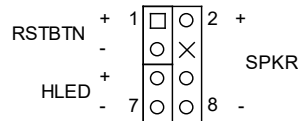

Table 28: Pin Assignment FP1

Pin	Signal	Note
1	Reset Button +	
2	Speaker +	
3	Reset Button -	
4	NC	
5	HDD LED +	
6	Internal Speaker -	
7	HDD LED -	
8	Speaker -	



Internal Buzzer is enabled when Pin6-8 is shorted.

Table 29: Signal Description

Signal	Description
Reset Button -/+	Reset Button. This 2-pin connector is for chassis mounted reset button for system reboot without turning off the system power.
HDD LED -/+	Hard Disk Drive Activity LED. This 2-pin connector is for HDD Activity LED. Connect the HDD Activity LED cable to this connector. The HDD LED lights up or flashes when data is read from or written to the HDD.
Internal Speaker - Speaker -/+	System warning speaker. The speaker allows user to hear beeps and warnings.

Figure 20: Front Panel Pin Header FP2

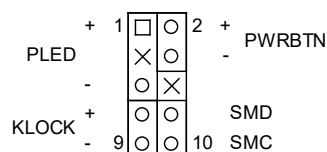

Table 30: Pin Assignment FP2

Pin	Signal	Note
1	Power LED +	
2	Power Button +	
3	NC	
4	Power Button -	
5	Power LED -	
6	SMB_ALERT#	
7	BATLOW#	
8	SMBus Data	
9	GND	
10	SMBus Clock	

Table 31: Signal Description

Signal	Description
Power LED -/+	System Power LED. The power LED lights up when users turn on the system power, and blinks when the system is in sleep mode.
Power Button -/+	The 2-pin connector is for the system power button. Pressing the power button turns the system on or puts the system in sleep or soft-off mode depending on the operating system settings. Pressing the power switch for more than four seconds while the system turns from ON to OFF.
SMB_ALERT #	System Management Bus Alert
SMBus Data	System Management Bus bidirectional data line
SMBus Clock	System Management Bus bidirectional clock line
BATLOW#	Battery low input. This signal may be driven low by external circuitry to signal that the system battery is low. It also can be used to signal some other external power management event.

7.9. Serial COM1 - COM6 Ports (CN20 - CN25)

Figure 21: Serial COM CN20 - CN25

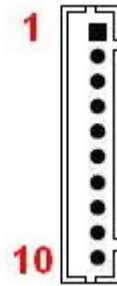

Table 32: Pin Assignment CN20, CN21

Pin	RS232 Signal	RS422 Signal	Half Duplex RS485 Signal	Full Duplex RS485 Signal	Note
1	DCD	TX-	DATA-	TX-	
2	DSR	N/A	N/A	N/A	
3	RXD	TX+	DATA+	TX+	
4	RTS	N/A	N/A	N/A	
5	TXD	RX+	N/A	RX+	
6	CTS	N/A	N/A	N/A	
7	DTR	RX-	N/A	RX-	
8	RI	N/A	N/A	N/A	
9	GND	GND	GND	GND	
10	+5V	+5V	+5V	+5V	

Table 33: Pin Assignment CN22 - CN25

Pin	RS232 Signal	Note
1	DCD	
2	DSR	
3	RXD	
4	RTS	
5	TXD	
6	CTS	
7	DTR	
8	RI	
9	GND	
10	+5V	



The COM ports need to install an OS patch from ITE. The patch is only available for Windows and is not available Linux.

Table 34: Signal Description

Signal	Description
TXD	Transmitted Data, sends data to the communications link. The signal is set to the marking state (-12 V) on hardware reset when the transmitter is empty or when loop mode operation is initiated.
RXD	Received Data, receives data from the communications link.
DTR	Data Terminal Ready, indicates to the modem etc. that the on-board UART is ready to establish communication link.
DSR	Data Set Ready, indicates that the modem etc. is ready to establish a communications link.
RTS	Request To Send, indicates to the modem etc. that the on-board UART is ready to exchange data.
CTS	Clear To Send, indicates that the modem or data set is ready to exchange data.
DCD	Data Carrier Detect, indicates that the modem or data set has detected the data carrier.
RI	Ring Indicator, indicates that the modem has received a ringing signal from the telephone line.
TX+/-	Transmitted Data differential pair sends data to the communications link.
RX+/-	Received Data differential pair receives data from the communications link.
GND	Power Supply GND signal

7.10. LVDS Panel Connector (CN3)

The LVDS connector is based on 30-pole connector type JAE JS-1267-30(G1)NH.

Figure 22: LVDS Connector CN3

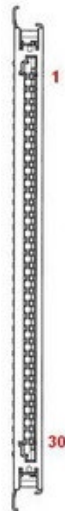

Table 35: Pin Assignment CN3

Pin	Signal	Note
1	LVDS_A0-	
2	LVDS_A0+	
3	LVDS_A1-	
4	LVDS_A1+	
5	LVDS_A2-	

Pin	Signal	Note
6	LVDS_A2+	
7	GND	
8	LVDS_ACLK-	
9	LVDS_ACLK+	
10	LVDS_A3-/NC	
11	LVDS_A3+/NC	
12	LVDS_B0-	
13	LVDS_B0+	
14	GND	
15	LVDS_B1-	
16	LVDS_B1+	
17	GND	
18	LVDS_B2-	
19	LVDS_B2+	
20	LVDS_BCLK-	
21	LVDS_BCLK+	
22	LVDS_B3-/NC	
23	LVDS_B3+/NC	
24	GND	
25	DDC_DATA	
26	VDDEN	
27	DDC_CLK	
28	+3.3V / +5V *	
29	+3.3V / +5V*	
30	+3.3V / +5V*	



* Panel Power can be selected by JP4.

Table 36: Signal Description

Signal	Description
LVDS_A0..A3	LVDS A Channel data
LVDS_ACLK	LVDS A Channel clock
LVDS_B0..B3	LVDS B Channel data
LVDS_BCLK	LVDS B Channel clock
VDDEN	Output Display Enable
DDC_DATA	DDC channel Data
DDC_CLK	DDC Channel Clock

7.11. Backlight Power Output Wafer (CN26)

Figure 23: Backlight Power Output Wafer CN26

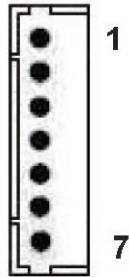

Table 37: Pin Assignment CN26

Pin	Signal	Note
1	BL_ADJ_PWM*	
2	BL_ADJ_VOL*	
3	GND	
4	+5V / +12V**	
5	+5V / +12V**	
6	GND	
7	BL_EN***	



* BL_ADJ can be setting in BIOS setup.



** Backlight Power can be selected by JP4.



*** BL_EN can be selected by JP2.

Table 38: Signal Description

Signal	Description
BL_ADJ_PWM	Backlight Adjustment PWM (Pulse Width Modulation) signal
BL_ADJ_VOL	Backlight Adjustment Voltage signal
BL_EN	Backlight Enable signal

7.12. VGA Header (CN6)

The VGA connector is supplied via the VGA header (CN6). Only one output is supported between the VGA header (CN6) and LVDS panel connector (CN3).

Figure 24: VGA Header CN6

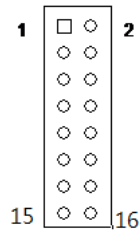

Table 39: Pin Assignment CN6

Pin	Signal	Note
1	Red	
2	Green	
3	Blue	
4	NC	
5	GND	
6	GND	
7	GND	
8	GND	
9	+5V	
10	GND	
11	NC	
12	DDC_DATA	
13	HSYNC	
14	VSYNC	
15	DDC_CLK	
16	NC	

7.13. Digital Input / Output Wafer (CN11)

Figure 25: Digital Input / Output Wafer CN11

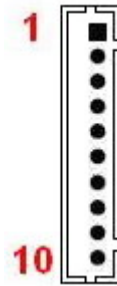

Table 40: Pin Assignment CN11

Pin	Signal	Note
1	+5V	
2	DI0	
3	DO0	
4	DI1	
5	DO1	
6	DI2	
7	DO2	
8	DI3	
9	DO3	
10	GND	

7.14. mPCIe Slot Connector (MPCIE1 & MPCIE2)

Full-sized Mini-PCI Express V1.2 socket (MPCIE1). Socket MPCIE1 supports mPCIe, USB 2.0 and SIM-card socket. The SIM-card socket makes it possible to use a 3G/4G-wireless modem in this mPCIe slot. The USB does support WAKE function.

Half-sized Mini-PCI Express V1.2 socket (MPCIE2). Socket MPCIE2 supports mPCIe and USB 2.0. The USB does support WAKE function. This socket is replaced with an mSATA socket for some model.

Figure 26: mPCIe Slot Connector MPCIE1, MPCIE2

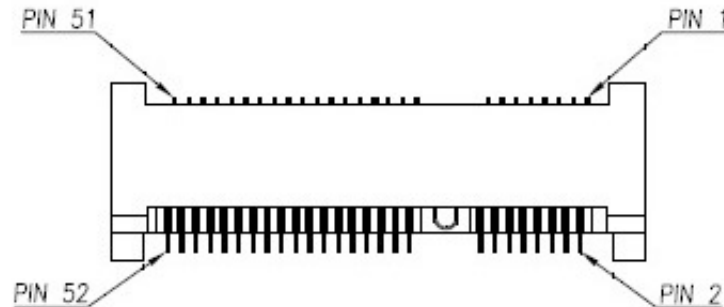

Table 41: Pin Assignment MPCIE1

Pin	Signal	Note
1	WAKE#	
2	+3.3VSB	
3	Reserved	
4	Ground	
5	Reserved	
6	+1.5V	
7	CLKREQ#	
8	UIM_PWR*	
9	Ground	
10	UIM_DATA*	
11	REFCLK-	
12	UIM_CLK*	
13	REFCLK+	
14	UIM_RESET*	
15	Ground	
16	UIM_VPP*	
17	Reserved	
18	Ground	
19	Reserved	
20	W_Disable#	
21	Ground	
22	PERST#	
23	PERn0	

Pin	Signal	Note
24	+3.3VSB	
25	PERp0	
26	Ground	
27	Ground	
28	+1.5V	
29	Ground	
30	SMB_CLK	
31	PETn0	
32	SMB_DATA	
33	PETp0	
34	Ground	
35	Ground	
36	USB_D-	
37	Ground	
38	USB_D+	
39	+3.3VSB	
40	Ground	
41	+3.3VSB	
42	LED_WWAN#	
43	Ground	
44	LED_WLAN#	
45	Reserved	
46	LED_WPAN#	
47	Reserved	
48	+1.5V	
49	Reserved	
50	Ground	
51	Reserved	
52	+3.3VSB	



* These pins are connected to CN7 SIM Interface directly.

Table 42: Pin Assignment MPCIE2

Pin	Signal	Note
1	WAKE#	
2	+3.3VSB	
3	Reserved	
4	Ground	
5	Reserved	
6	+1.5V	

Pin	Signal	Note
7	CLKREQ#	
8	Reserved	
9	Ground	
10	Reserved	
11	REFCLK-	
12	Reserved	
13	REFCLK+	
14	Reserved	
15	Ground	
16	Reserved	
17	Reserved	
18	Ground	
19	Reserved	
20	W_Disable#	
21	Ground	
22	PERST#	
23	PERn0	
24	+3.3VSB	
25	PERp0	
26	Ground	
27	Ground	
28	+1.5V	
29	Ground	
30	SMB_CLK	
31	PETn0	
32	SMB_DATA	
33	PETp0	
34	Ground	
35	Ground	
36	USB_D-	
37	Ground	
38	USB_D+	
39	+3.3VSB	
40	Ground	
41	+3.3VSB	
42	LED_WWAN#	
43	Ground	
44	LED_WLAN#	
45	Reserved	
46	LED_WPAN#	
47	Reserved	
48	+1.5V	

Pin	Signal	Note
49	Reserved	
50	Ground	
51	Reserved	
52	+3.3VSB	

Table 43: Pin Assignment MPCIE2 (when replaced with mSATA socket)

Pin	Signal	Note
1	NC	
2	+3.3V	
3	NC	
4	Ground	
5	NC	
6	NC	
7	N/A	
8	NC	
9	Ground	
10	NC	
11	NC	
12	NC	
13	NC	
14	NC	
15	Ground	
16	NC	
17	NC	
18	Ground	
19	NC	
20	NC	
21	Ground	
22	NC	
23	SATA_RX+	
24	+3.3V	
25	SATA_RX-	
26	Ground	
27	Ground	
28	NC	
29	Ground	
30	NC	
31	SATA_TX-	
32	NC	
33	SATA_TX+	
34	Ground	
35	Ground	

Pin	Signal	Note
36	NC	
37	Ground	
38	NC	
39	+3.3V	
40	Ground	
41	+3.3V	
42	NC	
43	Ground	
44	NC	
45	NC	
46	NC	
47	NC	
48	NC	
49	NC	
50	Ground	
51	NC	
52	+3.3V	

7.15. SIM Interface Wafer for MPCIE1 (CN7)

Figure 27: SIM Interface Wafer CN7

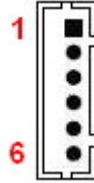

Table 44: Pin Assignment CN7

Pin	Signal	Description	Note
1	UIM_PWR	Power +5V or +3.3V	
2	UIM_DATA	Input or Output for serial data	
3	UIM_RESET	Reset signal	
4	UIM_VPP	Programming voltage input (optional)	
5	UIM_CLK	Clock signal	
6	GND	Ground	

7.16. PS/2 Keyboard and Mouse Wafer (CN4)

Attachment of a PS/2 keyboard / mouse can be done through the pinrow connector CN4.

Figure 28: PS/2 Keyboard / Mouse Wafer CN4

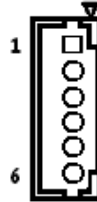

Table 45: Pin Assignment CN4

Pin	Signal	Note
1	MSCLK	
2	VCC	
3	MSDAT	
4	KBDAT	
5	GND	
6	KBCLK	

Table 46: Signal Description

Signal	Description
MSCLK	Bi-directional clock signal used to strobe data/commands from/to the PS/2 mouse.
MSDAT	Bi-directional serial data line used to transfer data from or commands to the PS/2 mouse.
KBCLK	Bi-directional clock signal used to strobe data/commands from/to the PC-AT keyboard.
KBDAT	Bi-directional serial data line used to transfer data from or commands to the PC-AT keyboard.

7.17. Micro-SD Card Cage (CN2)

Figure 29: Micro-SD Card Cage CN2

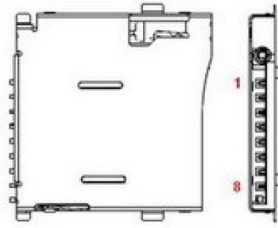

Table 47: Pin Assignment CN2

Pin	Signal	Note
1	DAT2	
2	CD/DAT3	
3	CMD	
4	VDD	
5	CLK	
6	GND	
7	DAT0	
8	DAT1	

7.18. mPCIE LED Activity Indicator Pin Header (JP3)

Figure 30: mPCIE LED Activity Indicator Pin Header JP3

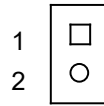

Table 48: Pin Assignment JP3

Pin	Signal	Note
1	LED+	
2	LED-	

7.19. Switches and Jumpers

The product has several jumpers which must be properly configured to ensure correct operation.

Figure 31: Jumper Connector

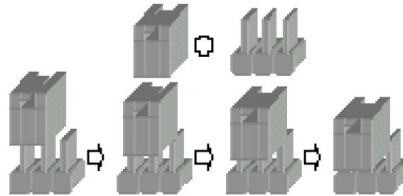

For a three-pin jumper (see Figure 31), the jumper setting is designated "1-2" when the jumper connects pins 1 and 2. The jumper setting is designated "2-3" when pins 2 and 3 are connected and so on. You will see that one of the lines surrounding a jumper pin is thick, which indicates pin No.1.

To move a jumper from one position to another, use needle-nose pliers or tweezers to pull the pin cap off the pins and move it to the desired position.

7.19.1. RTC Reset Selection (JP1)

The "RTC Reset" jumper (JP1) can be used to reset the Real Time Clock (RTC) and drain RTC well.

The jumper has one position: Pin 1-2 and not mounted (default position). More information on setting the "RTC Reset" jumper can be found in the following table.

Figure 32: RTC Reset Selection JP1

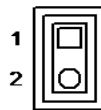

Table 49: Pin Assignment JP1

Jumper Position	Description
Pin 1-2	
X	Clear CMOS (board does not boot with the jumper in this position)
-	Normal operation (default position)

"X" = Jumper set (short) and "-" = jumper not set (open)



Do not leave the jumper in position 1-2, otherwise if the power is disconnected, the battery will fully deplete within a few weeks.

7.19.2. Backlight Enable Selection (JP2)

Figure 33: Backlight Enable Selection JP2

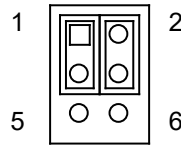

Table 50: Pin Assignment JP2

Jumper 1 Position		Description
Pin 1-3	Pin 3-5	
X	-	Backlight Enable Voltage = +3.3V
-	X	Backlight Enable Voltage = +5V
Jumper 2 Position		Description
Pin 2-4	Pin 4-6	
X	-	Backlight Enable High Active
-	X	Backlight Enable Low Active

"X" = Jumper set (short) and "-" = jumper not set (open)

7.19.3. Panel & Backlight Power Selection (JP4)

Figure 34: Panel & Backlight Power Selection JP4

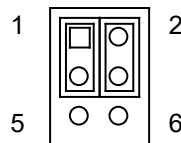

Table 51: Pin Assignment JP4

Jumper 1 Position		Description
Pin 1-3	Pin 3-5	
X	-	Backlight Power = +12V
-	X	Backlight Power = +5V
Jumper 2 Position		Description
Pin 2-4	Pin 4-6	
X	-	Panel Power = +3,3V
-	X	Panel Power = +5V

"X" = Jumper set (short) and "-" = jumper not set (open)

7.19.4. USB Power Selection (JP6)

Figure 35: USB Power Selection JP6

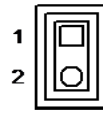

Table 52: Pin Assignment JP6

Jumper Position		Description
Pin 1-2		
X		USB power is always supply.
-		USB power will be cut off in S4 & S5 state.

"X" = Jumper set (short) and "-" = jumper not set (open)

7.19.5. ME F/W Selection (JP7)

Figure 36: ME F/W Selection JP7

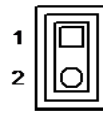

Table 53: Pin Assignment JP7

Jumper Position		Description
Pin 1-2		
X		ME F/W Disabled
-		Normal Operation

"X" = Jumper set (short) and "-" = jumper not set (open)

7.19.6. Keyboard Lock Selection (JP8)

Figure 37: Keyboard Lock Selection JP8



Table 54: Pin Assignment JP8

Jumper 1 Position			Description
Pin 1-2	Pin 2-3		
X	-		Normal Operation

Jumper 1 Position		Description
Pin 1-2	Pin 2-3	
-	X	Keyboard Locked

"X" = Jumper set (short) and "-" = jumper not set (open)

7.19.7. AT / ATX Power Mode Selection (JP9)

Figure 38: AT / ATX Power Mode Selection JP9



Table 55: Pin Assignment JP9

Jumper 1 Position		Description
Pin 1-2	Pin 2-3	
X	-	ATX Mode
-	X	AT Mode

"X" = Jumper set (short) and "-" = jumper not set (open)

8/ BIOS

8.1. Starting the uEFI BIOS

The ECX-BSW is provided with a Kontron-customized, pre-installed and configured version of AMI Aptio® V uEFI BIOS. AMI BIOS firmware is based on the Unified Extensible Firmware Interface (UEFI) specification and the Intel® Platform Innovation Framework for EFI. This uEFI BIOS provides a variety of new and enhanced functions specifically tailored to the hardware features of the ECX-BSW.

The uEFI BIOS comes with a setup program that provides quick and easy access to the individual function settings for control or modification of the uEFI BIOS configuration. The setup program allows the accessing of various menus that provide functions or access to sub-menus with more specific functions of their own.

To start the uEFI BIOS setup program, follow the steps below:

1. Power on the board.
2. Wait until the first characters appear on the screen (POST messages or splash screen).
3. Press the key.
4. If the uEFI BIOS is password-protected, a request for password will appear. Enter either the User Password or the Supervisor Password (see Security menu), press <RETURN>, and proceed with step 5.
5. A setup menu will appear.

The ECX-BSW uEFI BIOS setup program uses a hot key-based navigation system. A hot key legend bar is located on the bottom of the setup screens.

The following table provides information concerning the usage of these hot keys.

Table 56: Font Size Table

Hotkeys	Description
<F1>	The <F1> key invokes the General Help window.
<->	The <Minus> key selects the next lower value within a field.
<+>	The <Plus> key selects the next higher value within a field.
<F2>	The <F2> key loads the previous values.
<F3>	The <F3> key loads the standard default values.
<F4>	The <F4> key saves the current settings and exit the uEFI BIOS setup.
<→> or <←>	The <Left/Right> arrows selects major setup menus on the menu bar. For example: Main, Advanced, Security, etc.
<↑> or <↓>	The <Up/Down> arrows selects fields in the current menu. For example: A setup function or a sub-screen.
<ESC>	The <ESC> key exits a major setup menu and enter the Exit setup menu. Pressing the <ESC> key in a sub-menu displays the next higher menu level.
<RERURN>	The <RETURN> key executes a command or select a submenu.

8.2. Setup Menus

The Setup utility features shows six menus in the selection bar at the top of the screen:

- ▶ Main
- ▶ Advanced
- ▶ Power
- ▶ Security
- ▶ Boot
- ▶ Save & Exit

The Setup menus are selected via the left and right arrow keys. The currently active menu and the currently active uEFI BIOS Setup item are highlighted in white. Each Setup menu provides two main frames. The left frame displays all available functions. Functions that can be configured are displayed in blue. Functions displayed in gray provide information about the status or the operational configuration. The right frame displays an Item Specific Help window providing an explanation of the respective function.

8.2.1. Main Setup Menu

Upon entering the uEFI BIOS Setup program, the Main Setup menu is displayed. This screen lists the Main Setup menu sub-screens and provides basic system information. Additionally functions for setting the system time and date are offered.

Table 57: Main Setup Menu Sub-Screens and Functions

Function	Description
BIOS Information	Read only field. Displays information about the system BIOS
Memory Information	Read only field. Displays information about total memory
ME Information	Read only field. Displays information about Intel Management Engine (ME) version
TXE Information	Read only field. Displays information about TXE information
Firmware Information	Code version and firmware information
System Date	Set System Date
System Time	Set System Time

Figure 39: BIOS Main Menu Screen System Data and Time

BIOS SETUP UTILITY					
Main	Advanced	Power	Security	Boot	Save & Exit
Product Information					
Product Name		ECX-BSW-N3160			
BIOS Version		R0.07 (x64)			
BIOS Build Date		09/17/2015			
ME FW Version		02.00.00.2073			
CPU Information					
Intel® Celeron® CPU N3160 @ 1.60GHz					
Microcode Revision		34f			
Processor Cores		4		→ ←: Select Screen	
Memory Information					
Total Size		4069 MB (DDR3L)		↑ ↓: Select Item	
Frequency		1600 MHz		Enter: Select	
System Date		[Wed 11/18/2015]		+/-: Change Opt.	
System Time		[10:34:48]		F1: General Help	
Access Level		Administrator		F2: Previous Values	
				F3: Optimized Defaults	
				F4: Save & Exit	
				ESC: Exit	
Version 2.17.1249. Copyright (C) 2015, American Megatrends, Inc.					

Feature	Option	Description
System Date	[dd/mm/yyyy]	Set the Date. Use Tab to switch between Data elements.
System Time	[hh:mm:ss]	Set the Time. Use Tab to switch between Time elements.

8.2.2. Advanced Setup Menu

The Advanced setup menu provides sub-screens and functions for advanced configurations. The following sub-screen functions are included in the menu:

- ▶ LAN & Audio Configuration
- ▶ Display Configuration
- ▶ Super IO Configuration
- ▶ CPU Chipset Configuration
- ▶ SATA Configuration
- ▶ USB Configuration
- ▶ DIO Configuration
- ▶ H/W Monitor

NOTICE

Setting items on this screen to incorrect values may cause the system to malfunction.

Figure 40: BIOS Advanced Menu

BIOS SETUP UTILITY					
Main	Advanced	Power	Security	Boot	Save & Exit
Onboard LAN1 Controller		[Enabled]			
Onboard LAN1 Boot		[Disabled]			
Onboard LAN2 Controller		[Enabled]			
Onboard LAN2 Boot		[Disabled]			
Audio Controller		[Enabled]			
> Display Configuration					
> Super IO Configuration					
> CPU Chipset Configuration					
> SATA Configuration					
> USB Configuration					
> DIO Configuration					
> H/W Monitor					
				→ ←: Select Screen	
				↑ ↓: Select Item	
				Enter: Select	
				+/-: Change Opt.	
				F1: General Help	
				F2: Previous Values	
				F3: Optimized Defaults	
				F4: Save & Exit	
				ESC: Exit	
Version 2.17.1249. Copyright (C) 2015, American Megatrends, Inc.					

Feature	Option	Description
Onboard LAN1 Controller	[Disabled], [Enabled]	Select whether to enable or disable Onboard LAN1 Controller.
Onboard LAN1 Boot	[Disabled], [Enabled]	Select whether to enable or disable load onboard PXE (Preboot Execution Environment).
Onboard LAN2 Controller	[Disabled], [Enabled]	Select whether to enable or disable Onboard LAN2 Controller.
Onboard LAN2 Boot	[Disabled], [Enabled]	Select whether to enable or disable load onboard PXE (Preboot Execution Environment).
Audio Controller	[Disabled], [Enabled]	Select whether to enable or disable Audio Controller.

Figure 41: BIOS Advanced Menu - Display Configuration

BIOS SETUP UTILITY					
Main	Advanced	Power	Security	Boot	Save & Exit
Display Configuration					
Primary Display		[IGD]		→ ←: Select Screen ↑ ↓: Select Item Enter: Select +/-: Change Opt. F1: General Help F2: Previous Values F3: Optimized Defaults F4: Save & Exit ESC: Exit	
UWA Frame Buffer Size		[256MB]			
DVMT Pre-Allocated		[64M]			
DVMT Total Gfx Mem		[256M]			
Primary IGFX Boot Display		[VBIOS Default]			
Secondary IGFX Boot Display		[Disabled]			
VGA / LVDS Switch		[VGA]			
LVDS Panel Type*		[1024x768 24Bit 1CH]			
LVDS Backlight Control - Voltage*		[3.5V]			
Version 2.17.1249. Copyright (C) 2015, American Megatrends, Inc.					

* These items appear only when switching to LVDS.

Feature	Option	Description
Primary Display	[IGD], [PCIe], [Auto]	Select which graphic controller to be used as the primary display device.
UWA Frame Buffer Size	[128MB], [256MB], [512MB]	Select the Aperture Size.
DVMT Pre-Allocated	[32M], [64M], [96M], [128M], [160M], [192M], [224M], [256M], [288M], [320M], [352M], [384M], [416M], [448M], [480M], [512M]	Select DVMT Pre-Allocated (Fixed) Graphics Memory size used by the Internal Graphics Device.
DVMT Total Gfx Mem	[128M], [256M], [Max]	Select DVMT Total Graphic Memory size used by the Internal Graphics Device.
Primary IGFX Boot Display	[VBIOS Default], [DP], [HDMI], [VGA/LVDS]	Select the Video Device which will be activated during POST. This has no effect if external graphics present. Secondary boot display selection will appear based on your selection. DOS modes will be supported only on primary display.
Secondary IGFX Boot Display	[Disabled], [DP], [HDMI], [VGA/LVDS]	Select the Video Device which will be activated during POST. This has no effect if external graphics present. Secondary boot display selection will appear based on your selection. DOS modes will be supported only on primary display.
VGA/LVDS Switch	[VGA], [LVDS]	Select to switch VGA mode or LVDS mode.
LVDS Panel Type	[640x480 18Bit 1CH], [800x480 18Bit 1CH],	Select the appropriate setup item for LVDS panel.

Feature	Option	Description
	[800x600 18Bit 1CH], [1024x768 18Bit 1CH], [1440x900 18Bit 2CH], [1600x900 18Bit 2CH], [1024x600 18Bit 1CH], [1366x768 18Bit 1 CH], [1024x768 24Bit 1CH], [1280x1024 24Bit 2CH], [1366x768 24Bit 1CH], [1366x768 24Bit 2CH], [1440x900 24Bit 2CH], [1600x1200 24Bit 2CH], [1920x1080 24Bit 2CH], [1920x1200 24Bit 2CH]	
LVDS Backlight Control - Voltage	[0.0 V], [0.5 V], [1.0 V], [1.5 V], [2.0 V], [2.5 V], [3.0 V], [3.5 V], [4.0 V], [4.5 V], [5.0 V]	Select the voltage of LVDS backlight control mode.

Figure 42: BIOS Advanced Menu - Super IO Configuration

BIOS SETUP UTILITY					
Main	Advanced	Power	Security	Boot	Save & Exit
Super IO Configuration					
> Serial Port 1 Configuration > Serial Port 2 Configuration > Serial Port 3 Configuration > Serial Port 4 Configuration > Serial Port 5 Configuration > Serial Port 6 Configuration				→ ←: Select Screen ↑ ↓: Select Item Enter: Select +/-: Change Opt. F1: General Help F2: Previous Values F3: Optimized Defaults F4: Save & Exit ESC: Exit	
Version 2.17.1249. Copyright (C) 2015, American Megatrends, Inc.					

Figure 43: BIOS Advanced Menu - Super IO Configuration - Serial Port 1 Configuration

BIOS SETUP UTILITY					
Main	Advanced	Power	Security	Boot	Save & Exit
Serial Port 1 Configuration					
Serial Port		[Enabled]		→ ←: Select Screen ↑ ↓: Select Item Enter: Select +/-: Change Opt. F1: General Help F2: Previous Values F3: Optimized Defaults F4: Save & Exit ESC: Exit	
Device Settings		IO=3F8h; IRQ=4;			
Change Setting		[Auto]			
Serial Port 1 Type		[RS232]			
RS485 Deplx Mode*		[Half Duplex]			
RS485 Auto Flow Control*		[Disabled]			
Version 2.17.1249. Copyright (C) 2015, American Megatrends, Inc.					

* These items appear only when selecting RS485 for the Serial Port 1 Type.

Feature	Option	Description
Serial Port	[Disabled], [Enabled]	Select whether to enable or disable Serial Port (COM).
Change Settings	[Auto], [IO=3F8h; IRQ=4;], [IO=3F8h; IRQ=3, 4, 5, 6, 7, 9, 10, 11, 12;], [IO=2F8h; IRQ=3, 4, 5, 6, 7, 9, 10, 11, 12;], [IO=3E8h; IRQ=3, 4, 5, 6, 7, 9, 10, 11, 12;], [IO=2E8h; IRQ=3, 4, 5, 6, 7, 9, 10, 11, 12;]	Select an optional setting for Super IO device.

Feature	Option	Description
Serial Port 1 Type	[RS232], [RS422], [RS485]	Select an appropriate type for Serial Port 1.
RS485 Duplex Mode	[Half Duplex], [Full Duplex]	Select an appropriate RS485 Duplex Mode.
RS485 Auto Flow Control	[Disabled], [Enabled]	Select whether to enable or disable RS485 Auto Flow Control.

Figure 44: BIOS Advanced Menu - Super IO Configuration - Serial Port 2 Configuration

BIOS SETUP UTILITY					
Main	Advanced	Power	Security	Boot	Save & Exit
Serial Port 2 Configuration					
Serial Port		[Enabled]		→ ←: Select Screen	
Device Settings		IO=2F8h; IRQ=3;		↑ ↓: Select Item	
Change Setting		[Auto]		Enter: Select	
Serial Port 2 Type		[RS232]		+/-: Change Opt.	
RS485 Deplx Mode*		[Half Duplex]		F1: General Help	
RS485 Auto Flow Control*		[Disabled]		F2: Previous Values	
				F3: Optimized Defaults	
				F4: Save & Exit	
				ESC: Exit	
Version 2.17.1249. Copyright (C) 2015, American Megatrends, Inc.					

* These items appear only when selecting RS485 for the Serial Port 2 Type.

Feature	Option	Description
Serial Port	[Disabled], [Enabled]	Select whether to enable or disable Serial Port (COM).
Change Settings	[Auto], [IO=2F8h; IRQ=3;], [IO=3F8h; IRQ=3, 4, 5, 6, 7, 9, 10, 11, 12;], [IO=2F8h; IRQ=3, 4, 5, 6, 7, 9, 10, 11, 12;], [IO=3E8h; IRQ=3, 4, 5, 6, 7, 9, 10, 11, 12;], [IO=2E8h; IRQ=3, 4, 5, 6, 7, 9, 10, 11, 12;]	Select an optional setting for Super IO device.
Serial Port 2 Type	[RS232], [RS422], [RS485]	Select an appropriate type for Serial Port 2.
RS485 Duplex Mode	[Half Duplex], [Full Duplex]	Select an appropriate RS485 Duplex Mode.
RS485 Auto Flow Control	[Disabled], [Enabled]	Select whether to enable or disable RS485 Auto Flow Control.

Figure 45: BIOS Advanced Menu - Super IO Configuration - Serial Port 3 Configuration

BIOS SETUP UTILITY					
Main	Advanced	Power	Security	Boot	Save & Exit
Serial Port 3 Configuration					
Serial Port		[Enabled]		→ ←: Select Screen ↑ ↓: Select Item Enter: Select +/-: Change Opt. F1: General Help F2: Previous Values F3: Optimized Defaults F4: Save & Exit ESC: Exit	
Device Settings		IO=3E8h; IRQ=7;			
Change Setting		[Auto]			
Version 2.17.1249. Copyright (C) 2015, American Megatrends, Inc.					

Feature	Option	Description
Serial Port	[Disabled], [Enabled]	Select whether to enable or disable Serial Port (COM).
Change Settings	[Auto], [IO=3E8h; IRQ=7;], [IO=3E8h; IRQ=3, 4, 5, 6, 7, 9, 10, 11, 12;], [IO=2E8h; IRQ=3, 4, 5, 6, 7, 9, 10, 11, 12;], [IO=2F0h; IRQ=3, 4, 5, 6, 7, 9, 10, 11, 12;], [IO=2E0h; IRQ=3, 4, 5, 6, 7, 9, 10, 11, 12;]	Select an optional setting for Super IO device.

Figure 46: BIOS Advanced Menu - Super IO Configuration - Serial Port 4 Configuration

BIOS SETUP UTILITY					
Main	Advanced	Power	Security	Boot	Save & Exit
Serial Port 4 Configuration					
Serial Port		[Enabled]		→ ←: Select Screen ↑ ↓: Select Item Enter: Select +/-: Change Opt. F1: General Help F2: Previous Values F3: Optimized Defaults F4: Save & Exit ESC: Exit	
Device Settings		IO=2E8h; IRQ=7;			
Change Setting		[Auto]			
Version 2.17.1249. Copyright (C) 2015, American Megatrends, Inc.					

Feature	Option	Description
Serial Port	[Disabled], [Enabled]	Select whether to enable or disable Serial Port (COM).
Change Settings	[Auto], [IO=2E8h; IRQ=7;], [IO=3E8h; IRQ=3, 4, 5, 6, 7, 9, 10, 11, 12;], [IO=2E8h; IRQ=3, 4, 5, 6, 7, 9, 10, 11, 12;], [IO=2F0h; IRQ=3, 4, 5, 6, 7, 9, 10, 11, 12;], [IO=2E0h; IRQ=3, 4, 5, 6, 7, 9, 10, 11, 12;]	Select an optional setting for Super IO device.

Figure 47: BIOS Advanced Menu - Super IO Configuration - Serial Port 5 Configuration

BIOS SETUP UTILITY					
Main	Advanced	Power	Security	Boot	Save & Exit
Serial Port 5 Configuration					
Serial Port		[Enabled]		→ ←: Select Screen	
Device Settings		IO=2F0h; IRQ=7;		↑ ↓: Select Item	
Change Setting		[Auto]		Enter: Select	
				+/-: Change Opt.	
				F1: General Help	
				F2: Previous Values	
				F3: Optimized Defaults	
				F4: Save & Exit	
				ESC: Exit	
Version 2.17.1249. Copyright (C) 2015, American Megatrends, Inc.					

Feature	Option	Description
Serial Port	[Disabled], [Enabled]	Select whether to enable or disable Serial Port (COM).
Change Settings	[Auto], [IO=2F0h; IRQ=7;], [IO=3E8h; IRQ=3, 4, 5, 6, 7, 9, 10, 11, 12;], [IO=2E8h; IRQ=3, 4, 5, 6, 7, 9, 10, 11, 12;], [IO=2F0h; IRQ=3, 4, 5, 6, 7, 9, 10, 11, 12;], [IO=2E0h; IRQ=3, 4, 5, 6, 7, 9, 10, 11, 12;]	Select an optional setting for Super IO device.

Figure 48: BIOS Advanced Menu - Super IO Configuration - Serial Port 6 Configuration

BIOS SETUP UTILITY					
Main	Advanced	Power	Security	Boot	Save & Exit
Serial Port 6 Configuration					
Serial Port		[Enabled]		→ ←: Select Screen	
Device Settings		IO=2E0h; IRQ=7;		↑ ↓: Select Item	
Change Setting		[Auto]		Enter: Select	
				+/-: Change Opt.	
				F1: General Help	
				F2: Previous Values	
				F3: Optimized Defaults	
				F4: Save & Exit	
				ESC: Exit	
Version 2.17.1249. Copyright (C) 2015, American Megatrends, Inc.					

Feature	Option	Description
Serial Port	[Disabled], [Enabled]	Select whether to enable or disable Serial Port (COM).
Change Settings	[Auto], [IO=2E0h; IRQ=7;], [IO=3E8h; IRQ=3, 4, 5, 6, 7, 9, 10, 11, 12;], [IO=2E8h; IRQ=3, 4, 5, 6, 7, 9, 10, 11, 12;], [IO=2F0h; IRQ=3, 4, 5, 6, 7, 9, 10, 11, 12;], [IO=2E0h; IRQ=3, 4, 5, 6, 7, 9, 10, 11, 12;]	Select an optional setting for Super IO device.

Figure 49: BIOS Advanced Menu - CPU Chipset Configuration

BIOS SETUP UTILITY					
Main	Advanced	Power	Security	Boot	Save & Exit
CPU Chipset Configuration					
EIST		[Enabled]		→ ←: Select Screen	
CPU C state Report		[Enabled]		↑ ↓: Select Item	
Max CPU C-state		[C7]		Enter: Select	
SOix		[Disabled]		+/-: Change Opt.	
Limit CPUID Maximum		[Disabled]		F1: General Help	
Intel Virtualization Technology		[Disabled]		F2: Previous Values	
				F3: Optimized Defaults	
				F4: Save & Exit	
				ESC: Exit	
Version 2.17.1249. Copyright (C) 2015, American Megatrends, Inc.					

Feature	Option	Description
EIST	[Disabled], [Enabled]	Select whether to enable or disable Enhanced Intel SpeedStep Technology.
CPU C state Report	[Disabled], [Enabled]	Select whether to enable or disable CPU C state Report to OS.
Max CPU C-state	[C7], [C6], [C1]	Select Max C-state that the processor will support.
SOix	[Disabled], [Enabled]	Select whether to enable or disable SOix.
Limit CPUID Maximum	[Disabled], [Enabled]	Select whether to limit CPUID maximum value.
Intel Virtualization Technology	[Disabled], [Enabled]	Select whether to enable or disable Intel Virtualization Technology.

Figure 50: BIOS Advanced Menu - SATA Configuration

BIOS SETUP UTILITY					
Main	Advanced	Power	Security	Boot	Save & Exit
SATA Controller(s)					
Serial-ATA (SATA)		[Enabled]	→ ←: Select Screen		
SATA Interface Speed		[Gen3]	↑ ↓: Select Item		
Serial ATA Port 1		Empty	Enter: Select		
Port 1		[Enabled]	+/-: Change Opt.		
Serial ATA Port 2		Empty	F1: General Help		
Port 2		[Enabled]	F2: Previous Values		
			F3: Optimized Defaults		
			F4: Save & Exit		
			ESC: Exit		
Version 2.17.1249. Copyright (C) 2015, American Megatrends, Inc.					

Feature	Option	Description
Serial-ATA(SATA)	[Enabled], [Disabled]	Select whether to enable or disable SATA Device.
SATA Interface Speed	[Gen1], [Gen2], [Gen3]	Determine the maximum speed that the SATA controller can support.
Port 1..2	[Disabled], [Enabled]	Select whether to enable or disable SATA Port 1..2.

Figure 51: BIOS Advanced Menu - USB Configuration

BIOS SETUP UTILITY					
Main	Advanced	Power	Security	Boot	Save & Exit
USB Configuration					
USB Devices: 1 Keyboard, 1 Mouse, 1 Hub				→ ←: Select Screen ↑ ↓: Select Item Enter: Select +/-: Change Opt. F1: General Help F2: Previous Values F3: Optimized Defaults F4: Save & Exit ESC: Exit	
Legacy USB Support		[Enabled]			
XHCI Legacy Support		[Enabled]			
XHCI Hand-off		[Enabled]			
USB Mass Storage Driver Support		[Enabled]			
Version 2.17.1249. Copyright (C) 2015, American Megatrends, Inc.					

Feature	Option	Description
Legacy USB Support	[Enabled], [Disabled], [Auto]	Select whether to enable or disable Legacy USB support. AUTO option disables legacy support if no USB devices are connected.
XHCI Legacy Support	[Enabled], [Disabled]	Select whether to enable or disable XHCI Controller Legacy support.
XHCI Hand-off	[Enabled], [Disabled]	Select whether to enable or disable XHCI Hand-off function. This is a workaround for OSes without XHCI hand-off support. The XHCI ownership change should be claimed by XHCI driver.
USB Mass Storage Driver Support	[Disabled], [Enabled]	Select whether to enable or disable USB Mass Storage Driver Support.

Figure 52: BIOS Advanced Menu - DIO Configuration

BIOS SETUP UTILITY							
Main	Advanced	Power	Security	Boot	Save & Exit		
DIO Configuration							
User Configuration		[Disabled]					
DO_1*		[Output Low]					
DO_2*		[Output Low]					
DO_3*		[Output Low]					
DO_4*		[Output Low]					
DI_1		1		→ ←: Select Screen ↑ ↓: Select Item Enter: Select +/-: Change Opt. F1: General Help F2: Previous Values F3: Optimized Defaults F4: Save & Exit ESC: Exit			
DI_2		1					
DI_3		1					
DI_4		1					
DO_1		0					
DO_2		0					
DO_3		0					
DO_4		0					
Version 2.17.1249. Copyright (C) 2015, American Megatrends, Inc.							

* These items appear only when enabling User Configuration.

Feature	Option	Description
User Configuration	[Enabled], [Disabled]	Select whether or not to allow user to set the DO pin output value.
DO_1..4	[Output Low], [Output High]	Set up the DIO pin output value.

Figure 53: BIOS Advanced Menu - H/W Monitor

BIOS SETUP UTILITY					
Main	Advanced	Power	Security	Boot	Save & Exit
PC Health Status					
CPU Warning Temperature		[Disabled]			
> Smart FAN Configuration					
CPU Temperature		: +48 C		→ ←: Select Screen ↑ ↓: Select Item Enter: Select +/-: Change Opt. F1: General Help F2: Previous Values F3: Optimized Defaults F4: Save & Exit ESC: Exit	
System Temperature		: +47 C			
CPU Fan Speed		: N/A			
+VCORE		: +1.013 V			
+VIN		: +12.268 V			
+5V		: +5.066 V			
+VMEN		: +1.389 V			
Version 2.17.1249. Copyright (C) 2015, American Megatrends, Inc.					

Feature	Option	Description
CPU Warning Temperature	[Disabled], [80 C], [85 C], [90 C], [95 C]	Determine whether to enable or disable CPU Warning Temperature function and select a temperature that will sound an alarm.

BIOS SETUP UTILITY							
Main	Advanced	Power	Security	Boot	Save & Exit		
CPU FAN Configuration							
CPU FAN Setting		[Manual]		→ ←: Select Screen ↑ ↓: Select Item Enter: Select +/-: Change Opt. F1: General Help F2: Previous Values F3: Optimized Defaults F4: Save & Exit ESC: Exit			
Manual Duty		255					
Version 2.17.1249. Copyright (C) 2015, American Megatrends, Inc.							

Feature	Option	Description
CPU FAN Setting	[Manual], [Smart]	Switch the CPU FAN control mode.

8.2.3. Power Setup Menu

The Power setup menu provides functions and a sub-screen for power configurations. The following sub-screen function is included in the menu:

- ▶ WatchDog Timer Configuration

Figure 54: BIOS Power Setup Menu

BIOS SETUP UTILITY					
Main	Advanced	Power	Security	Boot	Save & Exit
Power Management Configuration					
ACPI Sleep State		[S3 (Suspend to RAM)]			
Restore AC Power Loss		[Power Off]			
Power Saving Mode		[Disabled]			
Resume Event Control				→ ←: Select Screen	
Resume From S3 By PS/2 Keyboard		[Disabled]		↑ ↓: Select Item	
Resume From S3 By PS/2 Mouse		[Disabled]		Enter: Select	
Resume By LAN Device		[Disabled]		+/-: Change Opt.	
Resume By PCI-E Device		[Disabled]		F1: General Help	
Resume By Ring Device		[Disabled]		F2: Previous Values	
Resume By RTC Alarm		[Disabled]		F3: Optimized Defaults	
> WatchDog Timer Configuration				F4: Save & Exit	
				ESC: Exit	
Version 2.17.1249. Copyright (C) 2015, American Megatrends, Inc.					

Feature	Option	Description
ACPI Sleep State	[Suspend Disabled], [S3 (Suspend to RAM)]	Select whether to enable or disable suspend function and determine an appropriate suspend mode.
Restore AC Power Loss	[Power Off], [Power On], [Last State]	Control whether the system will stay on after AC power is removed and then restored. Select [Power Off] if you want the system to remain off after power restored. Select [Power On] if you use a power strip to turn the system on.
Power Saving Mode	[Disabled], [EUP Enabled]	Select whether to enable Power Saving Mode.
Resume From S3 By PS/2 Keyboard	[Disabled], [Enabled]	Select whether to allow wakening the system up from the S3 sleep state by PS/2 keyboard.
Resume From S3 By PS/2 Mouse	[Disabled], [Enabled]	Select whether to allow wakening the system up from the S3 sleep state by PS/2 mouse.
Resume By LAN Device	[Disabled], [Enabled]	Select whether to enable or disable Wake from LAN Device.
Resume By PCI-E Device	[Disabled], [Enabled]	Select whether to enable or disable Wake from PCI-E Device.
Resume By Ring Device	[Disabled], [Enabled]	Select whether to enable or disable Wake from Ring Device.
Resume By RTC Alarm	[Disabled], [Enabled]	Select whether to enable or disable Wake Up on Alarm, to turn

Feature	Option	Description
		on your system on a special day of the month.

Figure 55: BIOS Power Setup Menu - WatchDog Timer Configuration

BIOS SETUP UTILITY					
Main	Advanced	Power	Security	Boot	Save & Exit
WatchDog Timer Configuration					
WDT Function		[Disabled]		→ ←: Select Screen ↑ ↓: Select Item Enter: Select +/-: Change Opt. F1: General Help F2: Previous Values F3: Optimized Defaults F4: Save & Exit ESC: Exit	
Version 2.17.1249. Copyright (C) 2015, American Megatrends, Inc.					

Feature	Option	Description
WDT Function	[Disabled], [Enabled]	Select whether to enable or disable WatchDog Timer function.

8.2.4. Security Setup Menu

The Security setup menu provides information about the passwords and functions for specifying the security settings. The passwords are case-sensitive. The ECX-BSW provides no factory-set passwords.

NOTICE

If there is already a password installed, the system asks for this first. To clear a password, simply enter nothing and acknowledge by pressing <RETURN>. To set a password, enter it twice and acknowledge by pressing <RETURN>.

Figure 56: BIOS Boot Setup Menu

BIOS SETUP UTILITY					
Main	Advanced	Power	Security	Boot	Save & Exit
Password Description If ONLY the Administrator's password is set, then this only limits access to Setup and is only asked for when entering Setup If ONLY the User's password is set, then this is a power on password and must be entered to boot or enter Setup. In Setup the User will have Administrator rights The password length must be in the following range:					
Minimum Length		3		→ ←: Select Screen	
Maximum length		20		↑ ↓: Select Item	
Administrator Password				Enter: Select	
User Password				+/-: Change Opt.	
HDD Security Configuration:				F1: General Help	
HDD 0: WDC WD 1600BE				F2: Previous Values	
				F3: Optimized Defaults	
				F4: Save & Exit	
				ESC: Exit	
Version 2.17.1249. Copyright (C) 2015, American Megatrends, Inc.					

Feature	Description
Administrator Password	Set administrator password
User Password	Set user password



If only the administrator's password is set, then only access to setup is limited. The password is only entered when entering setup.

If only the user's password is set, then the password is a power on password and must be entered to boot or enter setup. Within the setup menu the user has administrator rights.

Password length requirements are maximum 20 characters and minimum 3 characters.

8.2.4.1. Remember the password

It is highly recommended to keep a record of all passwords in a safe place. Forgotten passwords results in being locked out of the system.

If the system cannot be booted because the User Password or the Supervisor Password are not know, contact Kontron Support for further assistance.



HDD security passwords cannot be cleared using the above method.

8.2.5. Boot Setup Menu

The boot setup menu lists the for boot device priority order, that is generated dynamically.

Figure 57: BIOS Boot Setup Menu

BIOS SETUP UTILITY					
Main	Advanced	Power	Security	Boot	Save & Exit
Boot Configuration					
Full Screen LOGO Display		[Disabled]			
Setup Prompt Timeout		1		→ ←: Select Screen	
Bootup NumLock State		[On]		↑ ↓: Select Item	
Keyboard Detect Warning		[Enabled]		Enter: Select	
CSM Support		[Enabled]		+/-: Change Opt.	
Boot Option Filter		[Legacy Only]		F1: General Help	
Boot Option Priorities				F2: Previous Values	
				F3: Optimized Defaults	
				F4: Save & Exit	
				ESC: Exit	
Version 2.17.1249. Copyright (C) 2015, American Megatrends, Inc.					

Feature	Option	Description
Full Screen LOGO Display	[Disabled], [Enabled]	Select whether to enable or disable to display logo screen.
Bootup NumLock State	[On], [Off]	Select the state of the NumLock feature of the keyboard after Startup. [On]: The keys on the keypad will act as numeric keys. [Off]: The keys on the keypad will act as cursor keys.
Keyboard Detect Warning	[Enabled]	Select whether to enable or disable Keyboard Detect Warning function.
CSM Support	[Enabled], [Disabled]	Select whether to enable or disable CSM support.
Boot Option Filter	[UEFI and Legacy], [Legacy only], [UEFI only]	Control Legacy / UEFI ROMs priority.

8.2.6. Save & Exit Setup Menu

The exit setup menu provides functions for handling changes made to the UEFI BIOS settings and the exiting of the setup program.

Figure 58: BIOS Boot Setup Menu

BIOS SETUP UTILITY					
Main	Advanced	Power	Security	Boot	Save & Exit
Save Changes and Reset					
Discard Changes and Reset					
Save Options				→ ←: Select Screen	
Save Changes				↑ ↓: Select Item	
Discard Changes				Enter: Select	
Restore Defaults				+/-: Change Opt.	
				F1: General Help	
				F2: Previous Values	
				F3: Optimized Defaults	
				F4: Save & Exit	
				ESC: Exit	
Version 2.17.1249. Copyright (C) 2015, American Megatrends, Inc.					

Feature	Description
Save Changes and Exit	Exit system setup after saving the changes. Once you are finished making your selections, choose this option from the Exit menu to ensure the values you selected are saved to the CMOS RAM. The CMOS RAM is sustained by an onboard backup battery and stays on even when the PC is turned off. When you select this option, a confirmation window appears. Select [Yes] to save changes and exit.
Discard Changes and Exit	Exit system setup without saving any changes. Select this option only if you do not want to save the changes that you made to the Setup program. If you made changes to fields other than system date, system time, and password, the BIOS asks for a confirmation before exiting.
Save Changes	Save changes done so far to any of the setup values. This option allows you to save the selections you made. After selecting this option, a confirmation appears. Select [Yes] to save any changes.
Discard Changes	Discards changes done so far to any of the setup values. This option allows you to discard the selections you made and restore the previously saved values. After selecting this option, a confirmation appears. Select [Yes] to discard any changes and load the previously saved values.
Restore Defaults	Restore Default values for all the setup values. This option allows you to load optimal default values for each of the parameters on the Setup menus, which will provide the best performance settings for your system. The F9 key can be used for this operation.

Appendix A: List of Acronyms



The following table does not contain the complete acronyms used in signal names, signal type definitions or similar. A description of the signals is included in the I/O Connector and Internal connector chapters within this user guide.

Table 58: List of Acronyms

2D	Two-Dimensional
3D	Three-Dimensional
AT	Advanced Technology
ATX	Advanced Technology eXtended
BGA	Ball Grid Array
BIOS	Basic Input / Output System
BSP	Board Support Package
CMOS	Complementary Metal Oxide Semiconductor
CPU	Central Processing Unit
DC	Direct Current
DDC	Display Data Channel
DIO	Digital Input / Output
ECC	Error-Correcting Code
EEE	Electrical and Electronic Equipment
EOS	Electrical OverStress
ESD	ElectroStatic Discharge
GbE	Gigabit Ethernet
HDD	Hard Disk Drive
HDMI	High Definition Multimedia Interface
LAN	Local Area Network
LED	Light Emitting Device
LVDS	Low-Voltage Differential Signaling
ME F/W	Management Engine Firmware
mPCle	mini Peripheral Component Interconnect express
PC-AT	Personal Computer - Advanced Technology
PCB	Printed Circuit Board
PSU	Power Supply Unit
PVC	PolyViny Chloride
PWM	Pulse Width Modulation

RAM	Random Access Memory
ROM	Read-Only Memory
RTC	Real-Time Clock
SATA	Serial Advanced Technology Attachment
SDP	Serial Download Protocol
SELV	Safety Extra-Low Voltage
SIM	Subscriber Identity Module
SMBus	System Management Bus
SoC	System on Chip
SO-DIMM	Small Outline Dual In-line Memory Module
SPD	Serial Presence Detect
SPI	Serial Peripheral Interface
TDP	Thermal Design Power
TPM	Trusted Platform Module
UEFI	Unified Extensible Firmware Interface
USB	Universal Serial Bus
UTP	Update Transfer Protocol
VGA	Video Graphics Array
WDT	WatchDog Timer
WEEE	Waste Electrical and Electronic Equipment



About Kontron

Kontron, a global leader in embedded computing technology (ECT), offers a combined portfolio of secure hardware, middleware and services for Internet of Things (IoT) and Industry 4.0 applications. With its standard products and tailor-made solutions based on highly reliable state-of-the-art embedded technologies, Kontron provides secure and innovative applications for a variety of industries. As a result, customers benefit from accelerated time-to-market, reduced total cost of ownership, product longevity and the best fully integrated applications overall. Kontron is a listed company. Its shares are traded in the Prime Standard segment of the Frankfurt Stock Exchange and on other exchanges under the symbol "KBC". For more information, please visit: www.kontron.com

▼

PRODUCT CONTACT
POINT

KONTRON ASIA INC.

4F, No. 415, Ti-Ding Blvd.,
Sec. 2, Neihu District,
Taipei, Taiwan 114741
Tel.: + 886 2 2799 2789
Fax: + 886 2 2799 7399
SalesAsia@kontron.com