



ECX-BYT

Doc. User Guide, Rev. 1.3

Doc. ID: [To be Determined]

This page has been intentionally left blank

 ECX-BYT - USER GUIDE

Disclaimer

Kontron would like to point out that the information contained in this user guide may be subject to alteration, particularly as a result of the constant upgrading of Kontron products. This document does not entail any guarantee on the part of Kontron with respect to technical processes described in the user guide or any product characteristics set out in the user guide. Kontron assumes no responsibility or liability for the use of the described product(s), conveys no license or title under any patent, copyright or mask work rights to these products and makes no representations or warranties that these products are free from patent, copyright or mask work right infringement unless otherwise specified. Applications that are described in this user guide are for illustration purposes only. Kontron makes no representation or warranty that such application will be suitable for the specified use without further testing or modification. Kontron expressly informs the user that this user guide only contains a general description of processes and instructions which may not be applicable in every individual case. In cases of doubt, please contact Kontron.

This user guide is protected by copyright. All rights are reserved by Kontron. No part of this document may be reproduced, transmitted, transcribed, stored in a retrieval system, or translated into any language or computer language, in any form or by any means (electronic, mechanical, photocopying, recording, or otherwise), without the express written permission of Kontron. Kontron points out that the information contained in this user guide is constantly being updated in line with the technical alterations and improvements made by Kontron to the products and thus this user guide only reflects the technical status of the products by Kontron at the time of publishing.

Brand and product names are trademarks or registered trademarks of their respective owners.

©2022 by Kontron Europe GmbH

Kontron Europe GmbH

Gutenbergstraße 2
85737 Ismaning
Germany
www.kontron.com

High Risk Applications Hazard Notice

THIS DEVICE AND ASSOCIATED SOFTWARE ARE NOT DESIGNED, MANUFACTURED OR INTENDED FOR USE OR RESALE FOR THE OPERATION OF NUCLEAR FACILITIES, THE NAVIGATION, CONTROL OR COMMUNICATION SYSTEMS FOR AIRCRAFT OR OTHER TRANSPORTATION, AIR TRAFFIC CONTROL, LIFE SUPPORT OR LIFE SUSTAINING APPLICATIONS, WEAPONS SYSTEMS, OR ANY OTHER APPLICATION IN A HAZARDOUS ENVIRONMENT, OR REQUIRING FAIL-SAFE PERFORMANCE, OR IN WHICH THE FAILURE OF PRODUCTS COULD LEAD DIRECTLY TO DEATH, PERSONAL INJURY, OR SEVERE PHYSICAL OR ENVIRONMENTAL DAMAGE (COLLECTIVELY, "HIGH RISK APPLICATIONS").

You understand and agree that your use of Kontron devices as a component in High Risk Applications is entirely at your risk. To minimize the risks associated with your products and applications, you should provide adequate design and operating safeguards. You are solely responsible for compliance with all legal, regulatory, safety, and security related requirements concerning your products. You are responsible to ensure that your systems (and any Kontron hardware or software components incorporated in your systems) meet all applicable requirements. Unless otherwise stated in the product documentation, the Kontron device is not provided with error-tolerance capabilities and cannot therefore be deemed as being engineered, manufactured or setup to be compliant for implementation or for resale as device in High Risk Applications. All application and safety related information in this document (including application descriptions, suggested safety measures, suggested Kontron products, and other materials) is provided for reference only.

Revision History

Revision	Brief Description of Changes	Date of Issue
1.0	Initial Issue	2017-Dec-19
1.1	Add a LPS power supply notice in Sec. 2.1	2020-Apr-27
1.2	Audio codec chip replacement	2021-Mar-30
1.3	Modify USB 3.0 to USB 3.2 Gen 1 per new naming	2022-Jul-29

Terms and Conditions

Kontron warrants products in accordance with defined regional warranty periods. For more information about warranty compliance and conformity, and the warranty period in your region, visit <https://www.kontron.com/terms-and-conditions>.

Kontron sells products worldwide and declares regional General Terms & Conditions of Sale, and Purchase Order Terms & Conditions. Visit <https://www.kontron.com/terms-and-conditions>.

For contact information, refer to the corporate offices contact information on the last page of this user guide or visit our website [CONTACT US](#).

Customer Support

Find Kontron contacts by visiting: <https://www.kontron.com/support>.

Customer Service

As a trusted technology innovator and global solutions provider, Kontron extends its embedded market strengths into a services portfolio allowing companies to break the barriers of traditional product lifecycles. Proven product expertise coupled with collaborative and highly-experienced support enables Kontron to provide exceptional peace of mind to build and maintain successful products.

For more details on Kontron's service offerings such as: enhanced repair services, extended warranty, Kontron training academy, and more visit <https://www.kontron.com/support-and-services/services>.

Customer Comments

If you have any difficulties using this user guide, discover an error, or just want to provide some feedback, contact [Kontron support](#). Detail any errors you find. We will correct the errors or problems as soon as possible and post the revised user guide on our website.

Symbols

The following symbols may be used in this user guide

⚠ DANGER

DANGER indicates a hazardous situation which, if not avoided, will result in death or serious injury.

⚠ WARNING

WARNING indicates a hazardous situation which, if not avoided, could result in death or serious injury.

NOTICE

NOTICE indicates a property damage message.

⚠ CAUTION

CAUTION indicates a hazardous situation which, if not avoided, may result in minor or moderate injury.



Electric Shock!

This symbol and title warn of hazards due to electrical shocks (> 60 V) when touching products or parts of products. Failure to observe the precautions indicated and/or prescribed by the law may endanger your life/health and/or result in damage to your material.



ESD Sensitive Device!

This symbol and title inform that the electronic boards and their components are sensitive to static electricity. Care must therefore be taken during all handling operations and inspections of this product in order to ensure product integrity at all times.



HOT Surface!

Do NOT touch! Allow to cool before servicing.



Laser!

This symbol inform of the risk of exposure to laser beam and light emitting devices (LEDs) from an electrical device. Eye protection per manufacturer notice shall review before servicing.



This symbol indicates general information about the product and the user guide.

This symbol also indicates detail information about the specific product configuration.



This symbol precedes helpful hints and tips for daily use.

For Your Safety

Your new Kontron product was developed and tested carefully to provide all features necessary to ensure its compliance with electrical safety requirements. It was also designed for a long fault-free life. However, the life expectancy of your product can be drastically reduced by improper treatment during unpacking and installation. Therefore, in the interest of your own safety and of the correct operation of your new Kontron product, you are requested to conform with the following guidelines.

High Voltage Safety Instructions

As a precaution and in case of danger, the power connector must be easily accessible. The power connector is the product's main disconnect device.

CAUTION

Warning

All operations on this product must be carried out by sufficiently skilled personnel only.

CAUTION



Electric Shock!

Before installing a non hot-swappable Kontron product into a system always ensure that your mains power is switched off. This also applies to the installation of piggybacks. Serious electrical shock hazards can exist during all installation, repair, and maintenance operations on this product. Therefore, always unplug the power cable and any other cables which provide external voltages before performing any work on this product.

Earth ground connection to vehicle's chassis or a central grounding point shall remain connected. The earth ground cable shall be the last cable to be disconnected or the first cable to be connected when performing installation or removal procedures on this product.

Special Handling and Unpacking Instruction

NOTICE



ESD Sensitive Device!

Electronic boards and their components are sensitive to static electricity. Therefore, care must be taken during all handling operations and inspections of this product, in order to ensure product integrity at all times.

Do not handle this product out of its protective enclosure while it is not used for operational purposes unless it is otherwise protected.

Whenever possible, unpack or pack this product only at EOS/ESD safe work stations. Where a safe work station is not guaranteed, it is important for the user to be electrically discharged before touching the product with his/her hands or tools. This is most easily done by touching a metal part of your system housing.

It is particularly important to observe standard anti-static precautions when changing piggybacks, ROM devices, jumper settings etc. If the product contains batteries for RTC or memory backup, ensure that the product is not placed on conductive surfaces, including anti-static plastics or sponges. They can cause short circuits and damage the batteries or conductive circuits on the product.

Lithium Battery Precautions

If your product is equipped with a lithium battery, take the following precautions when replacing the battery.

CAUTION

Danger of explosion if the battery is replaced incorrectly.

- ▶ Replace only with same or equivalent battery type recommended by the manufacturer.
- ▶ Dispose of used batteries according to the manufacturer's instructions.

General Instructions on Usage

In order to maintain Kontron's product warranty, this product must not be altered or modified in any way. Changes or modifications to the product, that are not explicitly approved by Kontron and described in this user guide or received from Kontron Support as a special handling instruction, will void your warranty.

This product should only be installed in or connected to systems that fulfill all necessary technical and specific environmental requirements. This also applies to the operational temperature range of the specific board version that must not be exceeded. If batteries are present, their temperature restrictions must be taken into account.

In performing all necessary installation and application operations, only follow the instructions supplied by the present user guide.

Keep all the original packaging material for future storage or warranty shipments. If it is necessary to store or ship the product then re-pack it in the same manner as it was delivered.

Special care is necessary when handling or unpacking the product. See Special Handling and Unpacking Instruction.

Quality and Environmental Management

Kontron aims to deliver reliable high-end products designed and built for quality, and aims to complying with environmental laws, regulations, and other environmentally oriented requirements. For more information regarding Kontron's quality and environmental responsibilities, visit <https://www.kontron.com/about-kontron/corporate-responsibility/quality-management>.

Disposal and Recycling

Kontron's products are manufactured to satisfy environmental protection requirements where possible. Many of the components used are capable of being recycled. Final disposal of this product after its service life must be accomplished in accordance with applicable country, state, or local laws or regulations.

WEEE Compliance

The Waste Electrical and Electronic Equipment (WEEE) Directive aims to:

- ▶ Reduce waste arising from electrical and electronic equipment (EEE)
- ▶ Make producers of EEE responsible for the environmental impact of their products, especially when the product become waste
- ▶ Encourage separate collection and subsequent treatment, reuse, recovery, recycling and sound environmental disposal of EEE
- ▶ Improve the environmental performance of all those involved during the lifecycle of EEE



Environmental protection is a high priority with Kontron.

Kontron follows the WEEE directive

You are encouraged to return our products for proper disposal.

Table of Contents

Symbols	6
For Your Safety	7
High Voltage Safety Instructions	7
Special Handling and Unpacking Instruction	7
Lithium Battery Precautions	8
General Instructions on Usage	8
Quality and Environmental Management	8
Disposal and Recycling	8
WEEE Compliance	8
Table of Contents	9
List of Tables	10
List of Figures	11
1/ Introduction	13
2/ Installation Procedures	14
2.1. Installing the Board	14
2.2. Chassis Safety Standards	15
2.3. Lithium Battery Replacement	15
3/ System Specifications	17
3.1. System Block Diagram	17
3.2. Component Main Data	18
3.3. Environmental Conditions	19
3.4. Standards and Certifications	19
3.5. Processor Support	20
3.6. System Memory Support	20
3.6.1. Memory Operating Frequencies	20
3.7. On-board Graphics Subsystem	21
3.8. Power Supply	21
4/ Connector Locations	22
4.1. Top Side	22
4.2. Rear Side	24
4.3. Connector Panel Side	25
5/ Connector Definitions	26
6/ I/O-Area Connectors	27
6.1. HDMI Connector (HDMI1)	27
6.2. VGA Connector (VGA1)	28
6.3. Ethernet Connectors (LAN1 & LAN2)	29
6.4. USB Connectors (I/O Area)	30
7/ Internal Connectors	32
7.1. Power Connector	32
7.1.1. Power Input Wafer (CN1)	32
7.1.2. CR2032 Battery Power Input Wafer (BAT1)	32
7.2. DC5V Fan Wafer (FAN1)	33
7.3. SATA (Serial ATA) Disk Interfaces (SATA1)	34
7.4. HDD Power Output Wafer (CN3)	35
7.5. USB Connectors (Internal) (CN15, CN16)	36
7.6. Speaker Connector (CN11 & CN12)	38

7.7. Audio Connector (CN9)	38
7.8. Front Panel Pin Header (FP1 & FP2)	39
7.9. Serial COM1 - COM6 Ports (COM1 - COM6)	41
7.10. LVDS Flat Panel Connector (LVDS1).....	42
7.11. Backlight Power Output Wafer (CN14).....	44
7.12. Digital Input / Output Wafer (CN13)	45
7.13. mPCIe Slot Connector (MPCIE1).....	46
7.14. SIM Interface Wafer for MPCIE1 (CN10)	48
7.15. mSATA Socket (MSATA1)	49
7.16. PS/2 Keyboard and Mouse Wafer (CN2)	51
7.17. Switches and Jumpers	52
7.17.1. RTC Reset Selection (JP1)	52
7.17.2. MPCIE1 Activity LED Indication (JP2)	53
7.17.3. Backlight Enable Selection for LVDS1 (JP4).....	53
7.17.4. Panel & Backlight Power Selection for LVDS1 (JP5)	53
7.17.5. USB Power Selection (JP6).....	54
7.17.6. AT / ATX Power Mode Selection (JP7).....	54
7.17.7. ME F/W Selection (JP8).....	55
8/ On-Board Connectors & Mating Connector Types.....	56
9/ BIOS.....	57
9.1. Starting the uEFI BIOS	57
9.2. Setup Menus	58
9.2.1. Main Setup Menu.....	58
9.2.2. Advanced Setup Menu.....	60
9.2.3. Power Setup Menu.....	74
9.2.4. Boot Setup Menu	76
9.2.5. Security Setup Menu	77
9.2.5.1. Remember the password	78
9.2.6. Save & Exit Setup Menu	79
Appendix A: List of Acronyms	80
About Kontron	81

List of Tables

Table 1: Component Main Data	18
Table 2: Environmental Conditions	19
Table 3: Standards and Certifications	19
Table 4: Processor Support.....	20
Table 5: Memory Operating Frequencies.....	20
Table 6: Two-displays Configurations.....	21
Table 7: Supply Voltages	21
Table 8: Jumper List.....	22
Table 9: Top Side Internal Connector Pin Assignment.....	22
Table 10: Rear Side Internal Connector Pin Assignment	24
Table 11: Connector Panel Side Connector List	25
Table 12: Pin Assignment HDMI Connector HDMI1	27
Table 13: Pin Assignment VGA Connector VGA1.....	28
Table 14: Pin Assignment Ethernet Connectors LAN1, LAN2	29
Table 15: Pin Assignment USB 2.0 Connector CN6.....	30
Table 16: Pin Assignment USB 3.2 Gen 1 Connector USB1.....	30
Table 17: Signal Description.....	31

Table 18: Pin Assignment CN2	32
Table 19: Pin Assignment BAT1.....	32
Table 20: Pin Assignment FAN1	33
Table 21: Signal description.....	33
Table 22: Pin Assignment SATA1	34
Table 23: Signal Description.....	34
Table 24: Pin Assignment CN3	35
Table 25: Pin Assignment CN15.....	36
Table 26: Pin Assignment CN16.....	36
Table 27: Signal Description.....	36
Table 28: Pin Assignment CN11, CN12	38
Table 29: Pin Assignment CN8	38
Table 30: Pin Assignment FP1.....	39
Table 31: Signal Description	39
Table 32: Pin Assignment FP2	40
Table 33: Signal Description.....	40
Table 34: Pin Assignment COM1, COM2	41
Table 35: Pin Assignment COM3 - COM6.....	41
Table 36: Signal Description.....	42
Table 37: Pin Assignment LVDS1.....	42
Table 38: Signal Description	43
Table 39: Pin Assignment CN14.....	44
Table 40: Signal Description	44
Table 41: Pin Assignment CN13	45
Table 42: Pin Assignment MPCIE1	46
Table 43: Pin Assignment CN10	48
Table 44: Pin Assignment MSATA1.....	49
Table 45: Pin Assignment CN2	51
Table 46: Signal Description	51
Table 47: Pin Assignment JP1.....	52
Table 48: Pin Assignment JP2.....	53
Table 49: Pin Assignment JP4.....	53
Table 44: Pin Assignment JP5.....	54
Table 51: Pin Assignment JP6.....	54
Table 52: Pin Assignment JP7	54
Table 53: Pin Assignment JP8	55
Table 54: On-Board Connectors & Mating Connector Types.....	56
Table 55: Font Size Table.....	57
Table 56: Main Setup Menu Sub-Screens and Functions	58
Table 57: List of Acronyms.....	80

List of Figures

Figure 1: System Block Diagram ECX-BYT.....	17
Figure 2: Top Side	22
Figure 3: Rear Side.....	24
Figure 4: Connector Panel Side	25
Figure 5: HDMI Connector HDMI1.....	27
Figure 6: VGA Connector VGA1.....	28
Figure 7: Ethernet Connectors LAN1, LAN2.....	29
Figure 8: USB 2.0 Connector CN6	30
Figure 9: USB 3.2 Gen 1 Connector USB1	30
Figure 10: USB 2.0 High Speed Cable.....	31
Figure 11: USB 3.2 High Speed Cable	31
Figure 12: Power Input Wafer CN1.....	32
Figure 13: CR2032 Battery Power Input Wafer BAT1	32

Figure 14: DC5V Fan Wafer FAN1	33
Figure 15: SATA Connector SATA1.....	34
Figure 16: HDD Power Output Wafer CN3	35
Figure 17: USB 2.0 Port Wafer CN15	36
Figure 18: USB 2.0 Port 8, 9 Pin Header CN16.....	36
Figure 19: 3W Audio AMP Output Wafer CN11 (Right Channel), CN12 (Left Channel).....	38
Figure 20: Audio Input / Output Pin Header CN9.....	38
Figure 21: Front Panel Pin Header FP1	39
Figure 22: Front Panel Pin Header FP2.....	39
Figure 23: Serial COM COM1 - COM6	41
Figure 24: LVDS Connector LVDS1.....	42
Figure 25: Backlight Power Output Wafer CN14	44
Figure 26: Digital Input / Output Wafer CN13	45
Figure 27: mPCIe Slot Connector MPCIE1.....	46
Figure 28: SIM Interface Wafer CN10.....	48
Figure 29: Serial ATA Port-1 mSATA Socket MSATA1.....	49
Figure 30: PS/2 Keyboard / Mouse Wafer CN2	51
Figure 31: Jumper Connector.....	52
Figure 32: RTC Reset Selection JP1.....	52
Figure 33: MPCIE1 Activity LED Indication JP2.....	53
Figure 34: Backlight Enable Selection JP4	53
Figure 35: Panel & Backlight Power Selection JP5.....	53
Figure 36: USB Power Selection JP6.....	54
Figure 37: AT / ATX Power Mode Selection JP7	54
Figure 38: ME F/W Selection JP8.....	55
Figure 39: BIOS Main Menu Screen System Data and Time.....	59
Figure 40: BIOS Advanced Menu.....	61
Figure 41: BIOS Advanced Menu - Display Configuration	62
Figure 42: BIOS Advanced Menu - Super IO Configuration.....	64
Figure 43: BIOS Advanced Menu - Super IO Configuration - Serial Port 1 Configuration	64
Figure 44: BIOS Advanced Menu - Super IO Configuration - Serial Port 2 Configuration	65
Figure 45: BIOS Advanced Menu - Super IO Configuration - Serial Port 3 Configuration.....	66
Figure 46: BIOS Advanced Menu - Super IO Configuration - Serial Port 4 Configuration	66
Figure 47: BIOS Advanced Menu - Super IO Configuration - Serial Port 5 Configuration.....	67
Figure 48: BIOS Advanced Menu - Super IO Configuration - Serial Port 6 Configuration	68
Figure 49: BIOS Advanced Menu - CPU Chipset Configuration	69
Figure 50: BIOS Advanced Menu - SATA Configuration	70
Figure 51: BIOS Advanced Menu - USB Configuration	71
Figure 52: BIOS Advanced Menu - DIO Configuration.....	72
Figure 53: BIOS Advanced Menu - H/W Monitor	73
Figure 54: BIOS Power Setup Menu.....	74
Figure 55: BIOS Power Setup Menu - WatchDog Timer Configuration.....	75
Figure 56: BIOS Boot Setup Menu.....	76
Figure 57: BIOS Boot Setup Menu.....	77
Figure 58: BIOS Boot Setup Menu	79

1/ Introduction

This user guide describes the ECX-BYT board made by Kontron. This board will also be denoted ECX-BYT within this user guide.

Use of this user guide implies a basic knowledge of PC-AT hardware and software. This user guide focuses on describing the ECX-BYT board's special features and is not intended to be a standard PC-AT textbook.

New users are recommended to study the short installation procedure stated in the following chapter before switching on the power.

All configuration and setup of the CPU board is either carried out automatically or manually by the user via the BIOS setup menus.

Latest revision of this user guide, datasheet, thermal simulations, BIOS, drivers, BSP's (Board Support Packages), mechanical drawings (2D and 3D) can be downloaded from Kontron's Web Page.

2/ Installation Procedures

2.1. Installing the Board

NOTICE



ESD Sensitive Device

Electrostatic discharge (ESD) can damage equipment and impair electrical circuitry.

- ▶ Wear ESD-protective clothing and shoes
- ▶ Wear an ESD-preventive wrist strap attached to a good earth ground
- ▶ Check the resistance value of the wrist strap periodically (1 MΩ to 10 MΩ)
- ▶ Transport and store the board in its antistatic bag
- ▶ Handle the board at an approved ESD workstation
- ▶ Handle the board only by the edges

To get the board running follow these steps. If the board shipped from KONTRON already has components like RAM and CPU cooler mounted, then skip the relevant steps below.

1. Turn off the PSU (Power Supply Unit)

NOTICE

Turn off PSU (Power Supply Unit) completely (no mains power connected to the PSU) or leave the Power Connectors unconnected while configuring the board. Otherwise, components (RAM, LAN cards etc.) might get damaged. Make sure to use +12 V DC single supply only. Alternatively, use a standard ATX PSU with suitable cable kit and PS-ON# active.

NOTICE

The power supply unit shall comply with the requirements as defined in IEC 62368-1 according Clause 6.2.2 to power source category PS2 "Limited Power Source".

2. Insert the DDR3L 1333 / 1067 module(s)

Be careful to push the memory module in the slot(s) before locking the tabs.

3. Connecting interfaces

Insert all external cables for hard disk, keyboard etc. A monitor must be connected in order to change BIOS settings.

4. Connect and turn on PSU

Connect PSU to the board by the +12 V 3.0mm pitch 1x4-pin wafer connector.

5. BIOS setup

Enter the BIOS setup by pressing the key during boot up.

Enter "Exit Menu" and Load Setup Defaults.



To clear all BIOS setting, including Password protection, activate "Clear CMOS Jumper" for 10 sec (without power connected).

6. Mounting the board in chassis

NOTICE

When mounting the board to chassis etc. please note that the board contains components on both sides of the PCB that can easily be damaged if board is handled

without reasonable care. A damaged component can result in malfunction or no function at all.

When fixing the board on a chassis, it is recommended to use screws with an integrated washer and a diameter of > 7 mm. Do not use washers with teeth, as they can damage the PCB and cause short circuits.

2.2. Chassis Safety Standards

Before installing the ECX-BYT in the chassis, users must evaluate the end product to ensure compliance with the requirements of the IEC60950-1 safety standard:

- ▶ The board must be installed in a suitable mechanical, electrical and fire enclosure.
- ▶ The system, in its enclosure, must be evaluated for temperature and airflow considerations.
- ▶ The board must be powered by a CSA or UL approved power supply that limits the maximum input current.
- ▶ For interfaces having a power pin such as external power or fan, ensure that the connectors and wires are suitably rated. All connections from and to the product shall be with SELV circuits only.
- ▶ Wires have suitable rating to withstand the maximum available power.
- ▶ The peripheral device enclosure fulfils the IEC60950-1 fire protecting requirements.

2.3. Lithium Battery Replacement

If replacing the lithium battery follow the replacement precautions stated in the notification below:

⚠ CAUTION

Danger of explosion if the lithium battery is incorrectly replaced.

- ▶ Replace only with the same or equivalent type recommended by the manufacturer
- ▶ Dispose of used batteries according to the manufacturer's instructions

VORSICHT! Explosionsgefahr bei unsachgemäßem Austausch der Batterie.

- ▶ Ersatz nur durch denselben oder einen vom Hersteller empfohlenen gleichwertigen Typ
- ▶ Entsorgung gebrauchter Batterien nach Angaben des Herstellers

ATTENTION! Risque d'explosion avec l'échange inadéquat de la batterie.

- ▶ Remplacement seulement par le même ou un type équivalent recommandé par le producteur
- ▶ L'évacuation des batteries usagées conformément à des indications du fabricant

PRECAUCION! Peligro de explosi3n si la bater3a se sustituye incorrectamente.

- ▶ Sustituya solamente por el mismo o tipo equivalente recomendado por el fabricante
- ▶ Disponga las bater3as usadas seg3n las instrucciones del fabricante

ADVARSEL! Lithiumbatteri – Explosjonsfare ved feilagtig h3ndtering.

- ▶ Udsiftning m3 kun ske med batteri af samme fabrikat og type
- ▶ Lev3r det brugte batteri tilbage til leverand3ren

ADVARSEL! Explosjonsfare ved feilaktig skifte av batteri.

- ▶ Benytt samme batteritype eller en tilsvarende type anbefalt av apparatfabrikanten
- ▶ Brukte batterier kasseres i henhold til fabrikantens instruksjoner

WARNING! Explosionsfara vid felaktigt batteribyte.

- ▶ Anv3nd samma batterityp eller en ekvivalent typ som rekommenderas av apparattillverkaren
 - ▶ Kassera anv3nt batteri enligt fabrikantens instruktion
-

VAROITUS! Paristo voi räjähtää, jos se on virheellisesti asennettu.

- ▶ Vaihda paristo ainoastaan valmistajan suosittelemaan tyyppiin
 - ▶ Hävitä käytetty paristo valmistajan ohjeiden mukaisesti
-

3/ System Specifications

3.1. System Block Diagram

Figure 1: System Block Diagram ECX-BYT

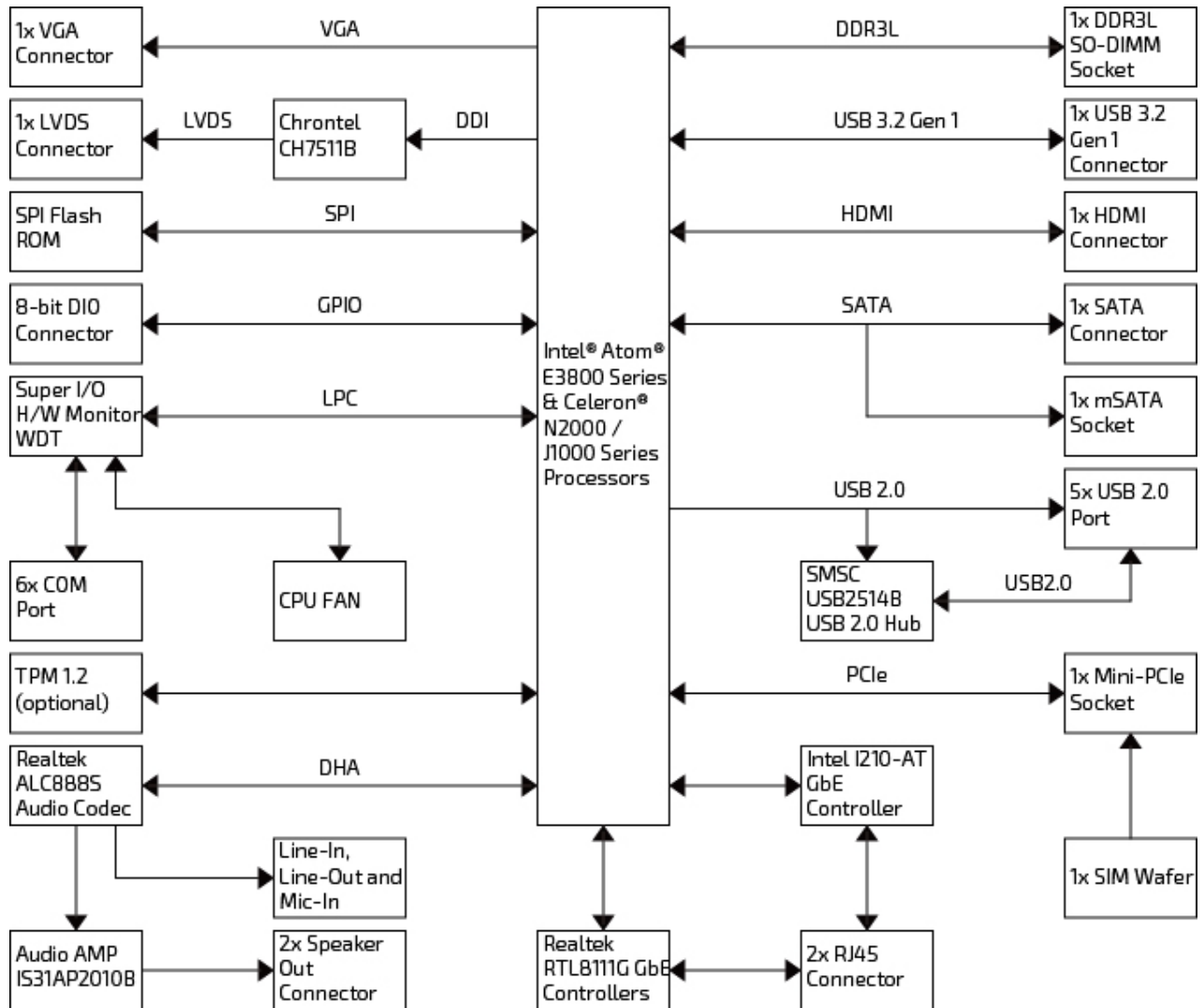

3.2. Component Main Data

The table below summarizes the features of the ECX-BYT single board computer.

Table 1: Component Main Data

System	
Processor	Intel® Atom® E3800 Series & Celeron® N2000 / J1000 Series Processors
Memory	1x DDR3L SO-DIMM memory socket
Video	
Display Interface	<ul style="list-style-type: none"> ▶ 1x LVDS (24-bit, 2-ch) ▶ 1x HDMI (on rear, 1920 x 1080 @ 60 Hz) ▶ 1x VGA (on rear, 2560 x 1600 @ 60 Hz)
Multiple Display	Dual
Audio	
Audio Codec	Realtek ALC888S
Audio Interface	<ul style="list-style-type: none"> ▶ 1x Speaker-out (Stereo, 3 W, by header) ▶ 1x Line-in (by header) ▶ 1x Line-out (by header) ▶ 1x Mic-in (by header)
Network Connection	
Ethernet	2x GbE LAN (RJ45 on rear, 1x Intel® I210-AT, 1x Realtek RTL8111G)
Peripheral Connection	
USB	<ul style="list-style-type: none"> ▶ 1x USB 3.2 Gen 1 (Type A on rear) ▶ 5x USB 2.0 (2x Type A on rear, 3x by header)
Serial Port	<ul style="list-style-type: none"> ▶ 2x RS232/422/485 (by header) ▶ 4x RS232 (by header)
Other I/Os	<ul style="list-style-type: none"> ▶ 1x PS/2 Keyboard / Mouse (by header) ▶ 8x DIO (by header)
Storage & Expansion	
Storage & Expansion	<ul style="list-style-type: none"> ▶ 1x SATA ▶ 1x mPCIe (full size) ▶ 1x mPCIe (full size) ▶ 1x SIM Card Cage (by wafer)
Power	
Input Voltage	DC 12 V
Connector	1x4-pin Lockable Wafer
Firmware	
BIOS	AMI uEFI BIOS w/ 64 Mb SPI Flash
Watchdog	Programmable WDT to generate system reset event
H/W Monitor	Voltages, Temperatures
Real Time Clock	SoC integrated RTC
Security	TPM 1.2 (Optional for models with Atom® E3845, Infineon SLB 9660)
System Control & Monitoring	

FP Header	<ul style="list-style-type: none"> ▶ 1x Header for Reset button, HDD LED & External Speaker ▶ 1x Header for Power button, Power LED & SM bus ▶ 1x Header for mPCIe activity LED
Cooling	
FAN	1x Wafer for CPU Smart Fan
Software	
OS Support	Windows 7, Windows 8, Windows 10, Linux
Mechanical	
Dimension (L x W)	3.5" ECX (146 x 105 mm / 5.75" x 4.13")

3.3. Environmental Conditions

The ECX-BYT is compliant with the following environmental conditions. It is the customer's responsibility to provide sufficient airflow around each of the components to keep them within the allowed temperature range.

Table 2: Environmental Conditions

Operating Temperature	0 °C ~ 60 °C / 32 °F ~ 140 °F (Standard) -20 °C ~ 70 °C / -4 °F ~ 158 °F (Extended)
Storage Temperature	-20 °C ~ 80 °C / -4 °F ~ 176 °F (Standard) -40 °C ~ 85 °C / -40 °F ~ 185 °F (Extended)
Humidity	0 % ~ 95 %

3.4. Standards and Certifications

The ECX-BYT meets the following standards and certification tests.

Table 3: Standards and Certifications

CE	<ul style="list-style-type: none"> ▶ EN 55032: 2015 + AC: 2016, CISPR 32: 2015 + COR1: 2016 ▶ AS/NZS CISPR 32: 2015 ▶ EN 61000-3-2: 2014, IEC 61000-3-2: 2014 ▶ EN 61000-3-3: 2013, IEC 61000-3-3: 2013 ▶ EN 55024: 2010 + A1: 2015, CISPR 24: 2010 + A1: 2015 ▶ EN 61000-4-2: 2009, IEC 61000-4-2: 2008 ▶ EN 61000-4-3: 2006 + A1: 2008 + A2: 2010, IEC 61000-4-3: 2006 + A1: 2007, + A2: 2010 ▶ EN 61000-4-4: 2012, IEC 61000-4-4: 2012 ▶ EN 61000-4-5: 2014, IEC 61000-4-5: 2014 ▶ EN 61000-4-6: 2014 + AC: 2015, IEC 61000-4-6: 2013 ▶ EN 61000-4-8: 2010, IEC 61000-4-8: 2009 ▶ EN 61000-4-11: 2004, IEC 61000-4-11: 2004
FCC	<ul style="list-style-type: none"> ▶ FCC CFR Title 47 Part 15 Subpart B: 2016 - Section 15.107 and 15.109 ▶ ANSI C63.4-2014 ▶ ICES-003 Issue 6: 2016 Class A

3.5. Processor Support

The ECX-BYT is designed to support Intel® Atom® E3800 Series & Celeron® N2000 / J1000 Series Processors. The BGA CPU is pre-mounted from factory. Kontron has defined the board versions as listed in the following table, so far all based on Embedded CPUs. Other versions are expected at a later date.

Table 4: Processor Support

Name	Core #	Speed	Turbo	Embedded	Cache	Socket	TDP	Tj
Atom® E3845	4	1.91 GHz	-	Yes	2M	FCBGA1170	10 W	-40 °C ~ 110 °C
Atom® E3825	2	1.33 GHz	-	Yes	1M	FCBGA1170	6 W	-40 °C ~ 110 °C
Celeron® N2807	2	1.58 GHz	2.16 GHz	Yes	1M	FCBGA1170	4.3 W	105 °C
Celeron® J1900	4	2.00 GHz	2.42 GHz	Yes	2M	FCBGA1170	10 W	105 °C

Sufficient cooling must be applied to the CPU in order to remove the effect as listed as TDP (Thermal Design Power) in above table. The sufficient cooling is also depending on the worst case maximum ambient operating temperature and the actual worst case load of processor.

3.6. System Memory Support

The ECX-BYT has one DDR3L SO-DIMM socket. The sockets support the following memory features:

- ▶ 1x DDR3L SO-DIMM 204-pin
- ▶ Up to 4GB (for model with Celeron® N2807)
- ▶ Up to 8GB (for other models)
- ▶ SPD timing supported
- ▶ ECC not supported

The installed DDR3L SO-DIMM should support the Serial Presence Detect (SPD) data structure. This allows the BIOS to read and configure the memory controller for optimal performance. If non-SPD memory is used, the BIOS will attempt to configure the memory settings, but performance and reliability may be impacted, or the board may not be able to boot totally.

3.6.1. Memory Operating Frequencies

In all modes, the frequency of system memory is the lowest frequency of all the memory modules placed in the system. Each memory module's frequency can be determined through the SPD registers on the memory modules.

The table below lists the resulting operating memory frequencies based on the combination of SO-DIMMs and processor.

Table 5: Memory Operating Frequencies

SO-DIMM Type	Module Name	Memory Data Transfer (MT/s)	Processor System Bus Frequency (MHz)	Resulting Memory Clock Frequency (MHz)	Peak Transfer Rate (MB/s)
DDR3L 1067	PC3-8500	1067	533	133	8533
DDR3L 1333	PC3-10600	1333	667	167	10667

Memory modules have in general a much lower longevity than embedded motherboards, and therefore EOL of modules can be expected several times during lifetime of the motherboard.

As a minimum it is recommend using Kontron memory modules for prototype system(s) in order to prove stability of the system and as for reference.

For volume production you might request to test and qualify other types of RAM. In order to qualify RAM it is recommend configuring 3 systems running RAM Stress Test program in heat chamber at 60° C for a minimum of 24 hours.

3.7. On-board Graphics Subsystem

The ECX-BYT supports Intel® HD Graphics technology for high quality graphics capabilities. All ECX-BYT versions support two displays pipes.

Up to two displays can be used simultaneously and be used to implement independent or cloned display configuration.

Table 6: Two-displays Configurations

Display 1	Display 2	Max. Resolution (Px) at 60 Hz	
		Display 1	Display 2
LVDS	HDMI	1920x1200	1920x1080
LVDS	VGA	1920x1200	2560x1600
HDMI	VGA	1920x1080	2560x1600

3.8. Power Supply

In order to ensure safe operation of the board, the input power supply must monitor the supply voltage and shut down if the supply is out of range – refer to the actual power supply specification. Please note, in order to keep the power consumption to a minimal level, boards do not implement a guaranteed minimum load. In some cases, this can lead to compatibility problems with ATX power supplies that require a minimum load to stay in regulation. The ECX-BYT board must be powered through the ATX+12V-4p (4-pole) connector using standard ATX power supply.

ATX12V supply: ATX+12V-4p connector must be used in according to the ATX12V PSU standard.

NOTICE

Hot Plugging power supply is not supported. Hot plugging might damage the board.

The requirements to the supply voltages are as follows:

Table 7: Supply Voltages

Supply	Min.	Max.	Note
+12 V	11.4 V	12.6 V	Should be ±5% for compliance with the ATX specification

4/ Connector Locations

4.1. Top Side

Figure 2: Top Side

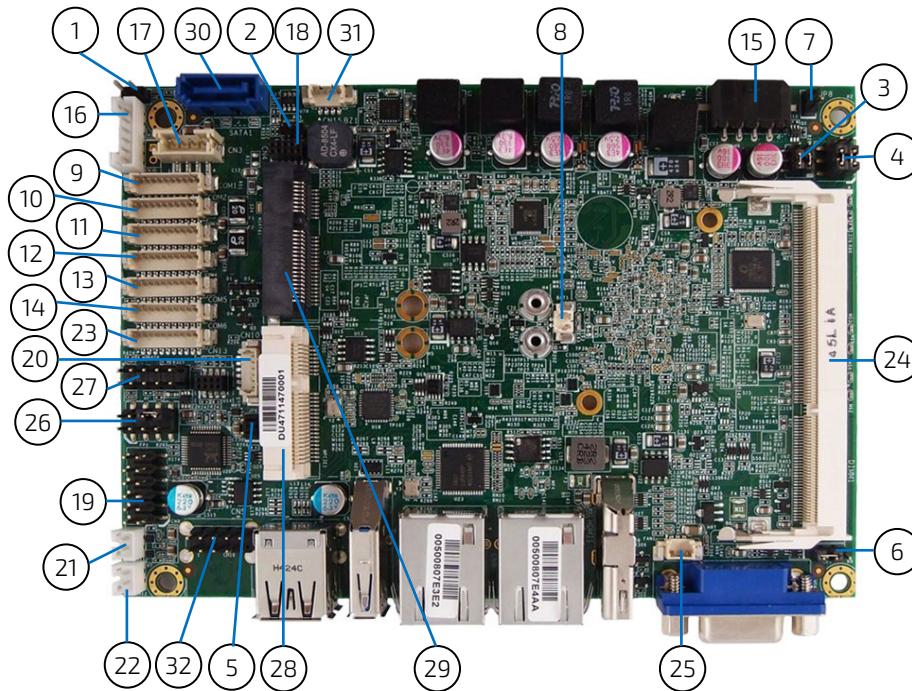

Table 8: Jumper List

Item	Designation	Description	See Chapter
1	JP1	RTC Reset Selection	7.17.1
2	JP2	MPCIE Activity LED Indication	7.17.2
3	JP4	Backlight Enable Selection	7.17.3
4	JP5	Panel & Backlight Power Selection	7.17.4
5	JP6	USB Power Selection	7.17.5
6	JP7	AT / ATX Power Mode Selection	7.17.6
7	JP8	ME F/W Selection	7.17.7

Table 9: Top Side Internal Connector Pin Assignment

Item	Designation	Description	See Chapter
8	BAT1	CR2032 Battery Power Input Wafer	7.1.2
9	COM1	RS-232/422/485 Port Wafer	7.9
10	COM2	RS-232/422/485 Port Wafer	7.9
11	COM3	RS-232 Port 3 Wafer	7.9
12	COM4	RS-232 Port 4 Wafer	7.9
13	COM5	RS-232 Port 5 Wafer	7.9
14	COM6	RS-232 Port 6 Wafer	7.9
15	CN1	DC12V Power Input Wafer	7.1.1
16	CN2	PS/2 Keyboard / Mouse Wafer	7.16

Item	Designation	Description	See Chapter
17	CN3	HDD Power Output Wafer	7.4
18	CN4	P80 Header	
19	CN9	Audio Input / Output Pin Header	7.7
20	CN10	SIM Interface Wafer for MPCIE2	7.14
21	CN11	Right Channel 3W Audio AMP Output Wafer	7.6
22	CN12	Left Channel 3W Audio AMP Output Wafer	7.6
23	CN13	Digital Input / Output Wafer	7.12
24	DIMM1	DDR3 Memory SO-DIMM Socket	
25	FAN1	DC5V FAN Wafer	7.2
26	FP1	Front Panel 1 Pin Header	7.8
27	FP2	Front Panel 2 Pin Header	7.8
28	MPCIE1	Mini-PCI Express v1.2 Socket (Full Size)	7.13
29	MSATA1	Serial ATA Port-1 mSATA Socket (Full Size)	7.15
30	SATA1	Serial ATA Port 0 Connector	7.3
31	CN15	USB 2.0 Port 2 Pin Header	7.5
32	CN16	USB 2.0 Port USBDN_1,2 Pin Header	7.5

4.2. Rear Side

Figure 3: Rear Side

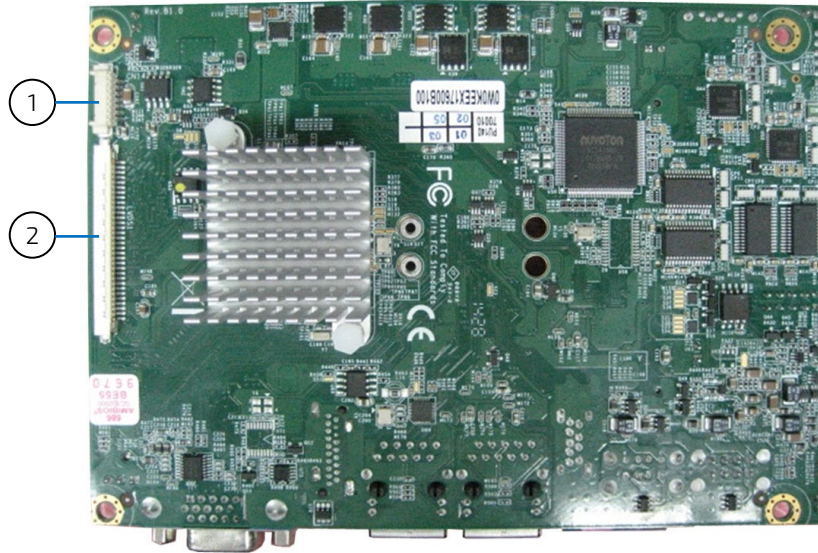

Table 10: Rear Side Internal Connector Pin Assignment

Item	Designation	Description	See Chapter
1	CN14	Backlight Power Output Wafer	7.11
2	LVDS1	18/24-bit, Single Channel LVDS Panel Connector	7.10

4.3. Connector Panel Side

Figure 4: Connector Panel Side

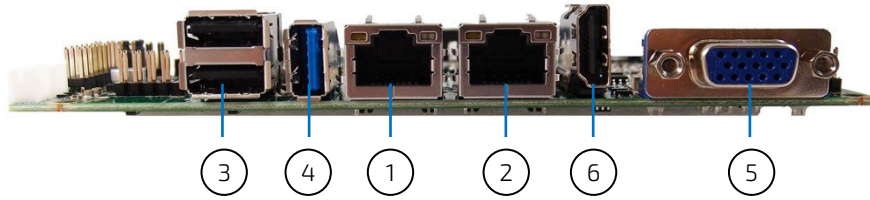

Table 11: Connector Panel Side Connector List

Item	Designation	Description	See Chapter
1	CN7	GbE LAN1 RJ-45 Connector	6.3
2	CN8	GbE LAN2 RJ-45 Connector	6.3
3	CN6	USB 2.0 Port 2,3 Type-A Connector	6.4
4	USB1	USB 3.2 Gen 1 Port 0 Connector	6.4
5	VGA1	VGA Connector	6.2
6	HDMI1	HDMI Connector	6.1

5/ Connector Definitions

The following defined terms are used within this user guide to give more information concerning the pin assignment and to describe the connector's signals.

Defined Term	Description
Pin	Shows the pin numbers in the connector
Signal	The abbreviated name of the signal at the current pin The notation "XX#" states that the signal "XX" is active low
Note	Special remarks concerning the signal
Designation	Type and number of item described
See Chapter	Number of the chapter within this user guide containing a detailed description

The abbreviation TBD is used for specifications that are not available yet or which are not sufficiently specified by the component vendors.

6/ I/O-Area Connectors

6.1. HDMI Connector (HDMI1)

The HDMI connector is based on standard HDMI type A.

Figure 5: HDMI Connector HDMI1

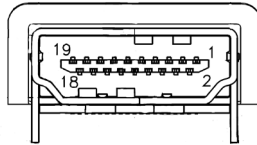

Table 12: Pin Assignment HDMI Connector HDMI1

Pin	Signal	Description	Note
1	TMDS Data2+		
2	Ground		
3	TMDS Data2-		
4	TMDS Data1+		
5	Ground		
6	TMDS Data1-		
7	TMDS Data0+		
8	Ground		
9	TMDS Data0-		
10	TMDS Clock+		
11	Ground		
12	TMDS Clock-		
13	Reserved		
14	Reserved		
15	DDC_CLK		
16	DDC_DATA		
17	Ground		
18	+5 V Power		
19	Hot Plug Detect		

6.2. VGA Connector (VGA1)

The external I/O connector panel support one DB-15 VGA female port.

Figure 6: VGA Connector VGA1

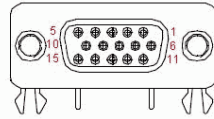

Table 13: Pin Assignment VGA Connector VGA1

Pin	Signal	Description	Note
1	Red		
2	Green		
3	Blue		
4	NC		
5	GND		
6	GND		
7	GND		
8	GND		
9	VCC		
10	GND		
11	NC		
12	DDC data		
13	HSYNC		
14	VSYNC		
15	DDC clock		

6.3. Ethernet Connectors (LAN1 & LAN2)

The ECX-BYT supports two channels of 10/100/1000 Mbit Ethernet, which are based Intel® I210-AT, and Realtek RTL8111G controllers respectively.

In order to achieve the specified performance of the Ethernet port, Category 5 twisted pair cables must be used with 10/100 MByte and Category 5E, 6 or 6E with 1 Gbit LAN networks.

The signals for the Ethernet ports are as follows:

Figure 7: Ethernet Connectors LAN1, LAN2

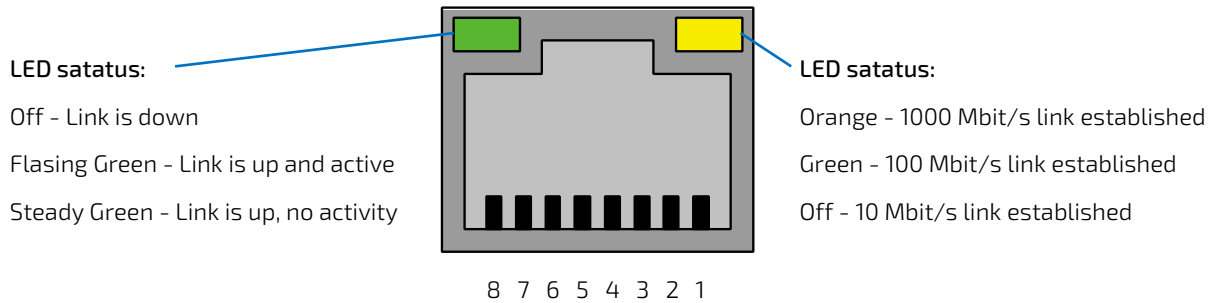

Table 14: Pin Assignment Ethernet Connectors LAN1, LAN2

Pin	Signal	Note
1	TX1+	
2	TX1-	
3	TX2+	
4	TX3+	
5	TX3-	
6	TX2-	
7	TX4+	
8	TX4-	

Signal Description

Signal	Description
TX1+ / TX1-	In MDI mode, this is the first pair in 1000Base-T, i.e. the BI_DA+/- pair, and is the transmit pair in 10Base-T and 100Base-TX. In MDI crossover mode, this pair acts as the BI_DB+/- pair, and is the receive pair in 10Base-T and 100Base-TX.
TX2+ / TX2-	In MDI mode, this is the second pair in 1000Base-T, i.e. the BI_DB+/- pair, and is the receive pair in 10Base-T and 100Base-TX. In MDI crossover mode, this pair acts as the BI_DA+/- pair, and is the transmit pair in 10Base-T and 100Base-TX.
TX3+ / TX3-	In MDI mode, this is the third pair in 1000Base-T, i.e. the BI_DC+/- pair. In MDI crossover mode, this pair acts as the BI_DD+/- pair.
TX4+ / TX4-	In MDI mode, this is the fourth pair in 1000Base-T, i.e. the BI_DD+/- pair. In MDI crossover mode, this pair acts as the BI_DC+/- pair.

'MDI' – media dependent Interface

6.4. USB Connectors (I/O Area)

The external I/O connector panel supports a dual USB 2.0 connector and a single USB 3.2 Gen 1 connector.



USB 3.2 Gen 1 port is backward compatible with USB 2.0.

Figure 8: USB 2.0 Connector CN6

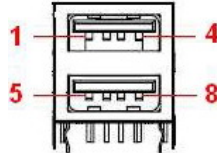

Table 15: Pin Assignment USB 2.0 Connector CN6

Pin	Signal	Note
Top		
1	+USBVCC	
2	USB_A-	USB 2.0 Differential Pair (-)
3	USB_A+	USB 2.0 Differential Pair (+)
4	GND	
Bottom		
5	+USBVCC	
6	USB_B-	USB 2.0 Differential Pair (-)
7	USB_B+	USB 2.0 Differential Pair (+)
8	GND	

Figure 9: USB 3.2 Gen 1 Connector USB1

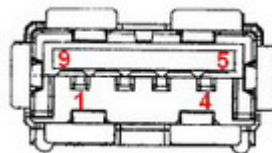

Table 16: Pin Assignment USB 3.2 Gen 1 Connector USB1

Pin	Signal	Note
1	+USBVCC*	+5 V Supply for USB device
2	USB_D-	USB 2.0 Differential Pair (-)
3	USB_D+	USB 2.0 Differential Pair (+)
4	GND	
5	USB_RX-	USB 3.2 Gen 1 Rx. Differential Pair (-)
6	USB_RX+	USB 3.2 Gen 1 Rx. Differential Pair (+)

Pin	Signal	Note
7	GND	
8	USB_TX-	USB 3.2 Gen 1 Tx. Differential Pair (-)
9	USB_TX+	USB 3.2 Gen 1 Tx. Differential Pair (+)



* The power source of +USBVCC can be selected by JP6.

Table 17: Signal Description

Signal	Description
USB_TX+, USB_TX-, USB_RX+, USB_RX-, USB_n-, USB_n-	Differential pair works as serial differential receive/transmit data lines. (n= A, B, D)
+USBVCC	5 V supply for external devices. VCC is supplied during power-down to allow wakeup on USB device activity. Protected by a 1A current limiting IC covering each of the USB port.

For HiSpeed rates it is required to use a USB cable, which is specified in USB 2.0 standard:

Figure 10: USB 2.0 High Speed Cable

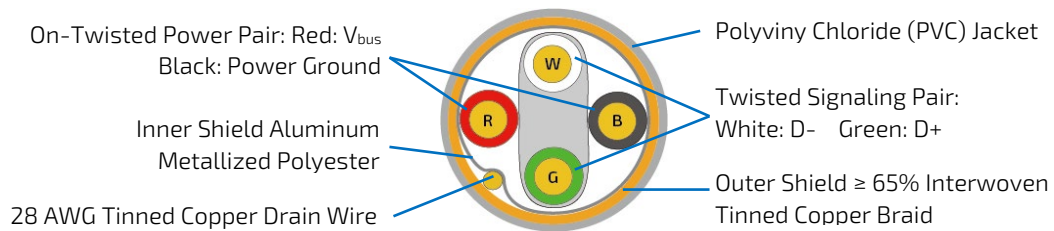

For USB 3.2 Gen 1 cabling it is required to use only HiSpeed USB cable, specified in USB 3.2 standard:

Figure 11: USB 3.2 High Speed Cable

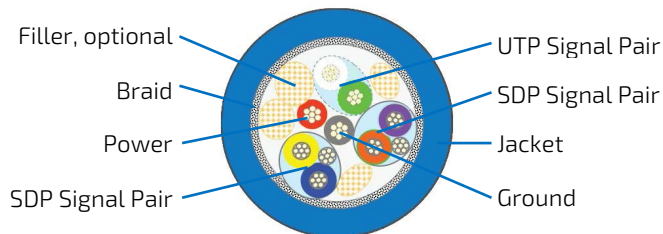

7/ Internal Connectors

7.1. Power Connector

Power connector must be used to supply the board with +12 VDC ($\pm 10\%$).

NOTICE

Hot plugging any of the power connector is not allowed.

Hot plugging might damage the board. In other words, turn off main supply etc. to make sure all the power lines are turned off when connecting to the motherboard.

7.1.1. Power Input Wafer (CN1)

Figure 12: Power Input Wafer CN1

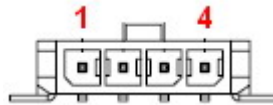

Table 18: Pin Assignment CN2

Pin	Signal	Description
1	+12Vin	Power +12 V
2	GND	Ground
3	GND	Ground
4	+12Vin	Power +12 V

7.1.2. CR2032 Battery Power Input Wafer (BAT1)

Figure 13: CR2032 Battery Power Input Wafer BAT1



Table 19: Pin Assignment BAT1

Pin	Signal	Description
1	Battery+	
2	Battery-	

7.2. DC5V Fan Wafer (FAN1)

The CPU FAN Wafer (FAN1) is used for the connection of the FAN for the CPU.

Figure 14: DC5V Fan Wafer FAN1

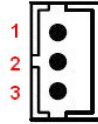

Table 20: Pin Assignment FAN1

Pin	Signal	Description
1	SENSE	Sense signal
2	+5V	Power +5 V
3	GND	Ground

Table 21: Signal description

Signal	Description
GND	Power Supply GND signal
5 V	+5 V supply for fan
SENSE	Sense input signal from the fan, for rotation speed supervision RPM (Rotations Per Minute). The signal shall be generated by an open collector transistor or similar.

7.3. SATA (Serial ATA) Disk Interfaces (SATA1)

The SATA connector supplies the data connection for the SATA hard disk and is SATA 2.0 compatible.

Figure 15: SATA Connector SATA1

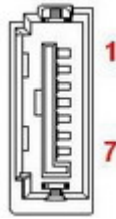

Table 22: Pin Assignment SATA1

Pin	Signal	Note
1	GND	
2	TX+	
3	TX-	
4	GND	
5	RX-	
6	RX+	
7	GND	

Table 23: Signal Description

Signal	Description
RX+ / RX-	Host transmitter differential signal pair
TX+ / TX-	Host receiver differential signal pair

7.4. HDD Power Output Wafer (CN3)

Figure 16: HDD Power Output Wafer CN3



Table 24: Pin Assignment CN3

Pin	Signal	Note
1	+12V	
2	GND	
3	GND	
4	+5V	

7.5. USB Connectors (Internal) (CN15, CN16)

The USB connectors (CN15 and CN16) support three USB 2.0 ports.

Figure 17: USB 2.0 Port Wafer CN15

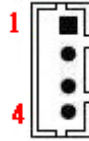

Table 25: Pin Assignment CN15

Pin	Signal	Note
1	+USBVCC	
2	USB_-	
3	USB_+	
4	GND	

Figure 18: USB 2.0 Port 8, 9 Pin Header CN16

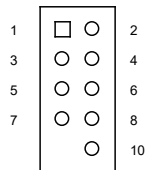

Table 26: Pin Assignment CN16

Pin	Signal	Note
1	+USBVCC	
2	+USBVCC	
3	USB_A-	
4	USB_B-	
5	USB_A+	
6	USB_B+	
7	GND	
8	GND	
9	KEY	
10	GND	



* The power source of +USBVCC can be selected by JP6.

Table 27: Signal Description

Signal	Description
+USBVCC	5 V supply for external devices. SB5V is supplied during power down to allow wakeup on USB device activity. Protected by active power switch 1 A fuse for each USB port.
USB_-/+ USB_A_-/+ USB_B_-/+	Universal Serial Bus Differentials: Bus Data / Address / Command Bus.

7.6. Speaker Connector (CN11 & CN12)

The Speaker audio-out interface is available through the wafers CN11 and CN12. These outputs are shared with the audio output (Line-out) signals of the audio pin header CN9.

Figure 19: 3W Audio AMP Output Wafer CN11 (Right Channel), CN12 (Left Channel)

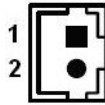

Table 28: Pin Assignment CN11, CN12

Pin	Signal	Note
1	Speaker+	
2	Speaker-	

7.7. Audio Connector (CN9)

The audio connector provides audio output (Line-Out), audio input (Line-In) and microphone (Mic-In) signals through the wafer CN9. The audio output signals are shared with those of the speaker connectors CN11 & CN12.

Figure 20: Audio Input / Output Pin Header CN9

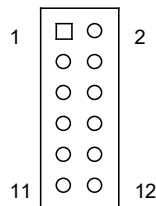

Table 29: Pin Assignment CN8

Pin	Signal	Note
1	MIC-In_L	
2	MIC-In_R	
3	MIC-In_JD#	
4	GND	
5	Line-In_L	
6	Line-In_R	
7	Line-In_JD#	
8	GND	
9	Line-Out_L	
10	Line-Out_R	
11	Line-Out_JD#	

Pin	Signal	Note
12	GND	

7.8. Front Panel Pin Header (FP1 & FP2)

Figure 21: Front Panel Pin Header FP1

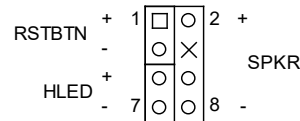

Table 30: Pin Assignment FP1

Pin	Signal	Note
1	Reset Button +	
2	Speaker +	
3	Reset Button -	
4	NC	
5	HDD LED +	
6	Internal Speaker -	
7	HDD LED -	
8	Speaker -	



Internal Buzzer is enabled when Pin6-8 is shorted.

Table 31: Signal Description

Signal	Description
Reset Button -/+	Reset Button. This 2-pin connector is for chassis mounted reset button for system reboot without turning off the system power.
HDD LED -/+	Hard Disk Drive Activity LED. This 2-pin connector is for HDD Activity LED. Connect the HDD Activity LED cable to this connector. The HDD LED lights up or flashes when data is read from or written to the HDD.
Internal Speaker - Speaker -/+	System warning speaker. The speaker allows user to hear beeps and warnings.

Figure 22: Front Panel Pin Header FP2

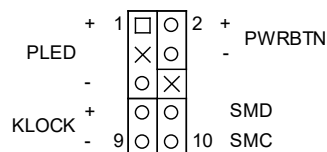

Table 32: Pin Assignment FP2

Pin	Signal	Note
1	Power LED +	
2	Power Button +	
3	NC	
4	Power Button -	
5	Power LED -	
6	SMB_ALERT#	
7	BATLOW#	
8	SMBus Data	
9	GND	
10	SMBus Clock	

Table 33: Signal Description

Signal	Description
Power LED -/+	System Power LED. The power LED lights up when users turn on the system power, and blinks when the system is in sleep mode.
Power Button -/+	The 2-pin connector is for the system power button. Pressing the power button turns the system on or puts the system in sleep or soft-off mode depending on the operating system settings. Pressing the power switch for more than four seconds while the system turns from ON to OFF.
SMB_ALERT #	System Management Bus Alert
SMBus Data	System Management Bus bidirectional data line
SMBus Clock	System Management Bus bidirectional clock line
BATLOW#	Battery low input. This signal may be driven low by external circuitry to signal that the system battery is low. It also can be used to signal some other external power management event.

7.9. Serial COM1 - COM6 Ports (COM1 - COM6)

Figure 23: Serial COM COM1 - COM6

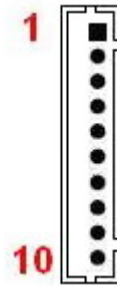

Table 34: Pin Assignment COM1, COM2

Pin	RS232 Signal	RS422 Signal	Half Duplex RS485 Signal	Full Duplex RS485 Signal	Note
1	DCD	TX-	DATA-	TX-	
2	DSR	N/A	N/A	N/A	
3	RXD	TX+	DATA+	TX+	
4	RTS	N/A	N/A	N/A	
5	TXD	RX+	N/A	RX+	
6	CTS	N/A	N/A	N/A	
7	DTR	RX-	N/A	RX-	
8	RI	N/A	N/A	N/A	
9	GND	GND	GND	GND	
10	+5V	+5V	+5V	+5V	

Table 35: Pin Assignment COM3 - COM6

Pin	RS232 Signal	Note
1	DCD	
2	DSR	
3	RXD	
4	RTS	
5	TXD	
6	CTS	
7	DTR	
8	RI	
9	GND	
10	+5V	



The COM ports need to install an OS patch from ITE. The patch is only available for Windows and is not available Linux.

Table 36: Signal Description

Signal	Description
TXD	Transmitted Data, sends data to the communications link. The signal is set to the marking state (-12 V) on hardware reset when the transmitter is empty or when loop mode operation is initiated.
RXD	Received Data, receives data from the communications link.
DTR	Data Terminal Ready, indicates to the modem etc. that the on-board UART is ready to establish communication link.
DSR	Data Set Ready, indicates that the modem etc. is ready to establish a communications link.
RTS	Request To Send, indicates to the modem etc. that the on-board UART is ready to exchange data.
CTS	Clear To Send, indicates that the modem or data set is ready to exchange data.
DCD	Data Carrier Detect, indicates that the modem or data set has detected the data carrier.
RI	Ring Indicator, indicates that the modem has received a ringing signal from the telephone line.
TX+/-	Transmitted Data differential pair sends data to the communications link.
RX+/-	Received Data differential pair receives data from the communications link.
GND	Power Supply GND signal

7.10. LVDS Flat Panel Connector (LVDS1)

The LVDS connector is based on 30-pole connector type JAE JS-1267-30(G1)NH.

Figure 24: LVDS Connector LVDS1

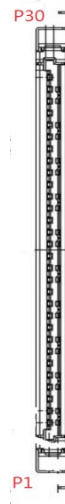

Table 37: Pin Assignment LVDS1

Pin	Signal	Note
1	LVDS_A0-	
2	LVDS_A0+	
3	LVDS_A1-	
4	LVDS_A1+	

Pin	Signal	Note
5	LVDS_A2-	
6	LVDS_A2+	
7	GND	
8	LVDS_ACLK-	
9	LVDS_ACLK+	
10	LVDS_A3-/NC	
11	LVDS_A3+/NC	
12	LVDS_B0-	
13	LVDS_B0+	
14	GND	
15	LVDS_B1-	
16	LVDS_B1+	
17	GND	
18	LVDS_B2-	
19	LVDS_B2+	
20	LVDS_BCLK-	
21	LVDS_BCLK+	
22	LVDS_B3-/NC	
23	LVDS_B3+/NC	
24	GND	
25	DDC_DATA	
26	VDDEN	
27	DDC_CLK	
28	+3.3V / +5V *	
29	+3.3V / +5V*	
30	+3.3V / +5V*	



* Panel Power can be selected by JP5.

Table 38: Signal Description

Signal	Description
LVDS_A0..A3	LVDS A Channel data
LVDS_ACLK	LVDS A Channel clock
LVDS_B0..B3	LVDS B Channel data
LVDS_BCLK	LVDS B Channel clock
VDDEN	Output Display Enable
DDC_DATA	DDC channel Data
DDC_CLK	DDC Channel Clock

7.11. Backlight Power Output Wafer (CN14)

Figure 25: Backlight Power Output Wafer CN14



Table 39: Pin Assignment CN14

Pin	Signal	Note
1	BL_ADJ_PWM*	
2	BL_ADJ_VOL*	
3	GND	
4	+5V / +12V**	
5	+5V / +12V**	
6	GND	
7	BL_EN***	



* BL_ADJ can be setting in BIOS setup.



** Backlight Power can be selected by JP5.



*** BL_EN can be selected by JP4.

Table 40: Signal Description

Signal	Description
BL_ADJ_PWM	Backlight Adjustment PWM (Pulse Width Modulation) signal
BL_ADJ_VOL	Backlight Adjustment Voltage signal
BL_EN	Backlight Enable signal

7.12. Digital Input / Output Wafer (CN13)

Figure 26: Digital Input / Output Wafer CN13

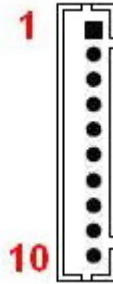

Table 41: Pin Assignment CN13

Pin	Signal	Note
1	+5V	
2	DIO_0	
3	DIO_1	
4	DIO_2	
5	DIO_3	
6	DIO_4	
7	DIO_5	
8	DIO_6	
9	DIO_7	
10	GND	

7.13. mPCIe Slot Connector (MPCIE1)

Full-sized Mini-PCI Express V1.2 socket (MPCIE1). Socket MPCIE1 supports mPCIe, USB 2.0 and SIM-card socket. The SIM-card socket makes it possible to use a 3G/4G-wireless modem in this mPCIe slot. The USB does support WAKE function.

Figure 27: mPCIe Slot Connector MPCIE1

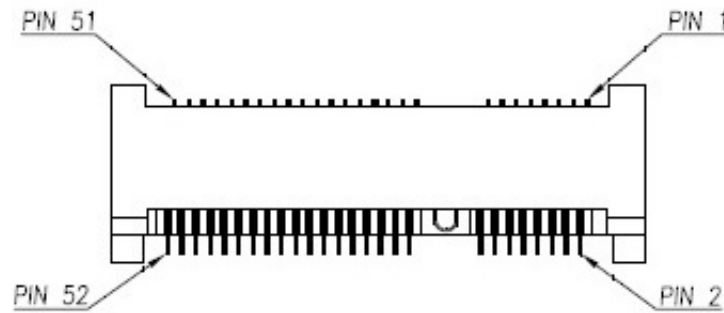

Table 42: Pin Assignment MPCIE1

Pin	Signal	Note
1	WAKE#	
2	+3.3VSB	
3	Reserved	
4	Ground	
5	Reserved	
6	+1.5V	
7	CLKREQ#	
8	UIM_PWR*	
9	Ground	
10	UIM_DATA*	
11	REFCLK-	
12	UIM_CLK*	
13	REFCLK+	
14	UIM_RESET*	
15	Ground	
16	UIM_VPP*	
17	Reserved	
18	Ground	
19	Reserved	
20	W_Disable#	
21	Ground	
22	PERST#	
23	PERn0	
24	+3.3VSB	
25	PERp0	

Pin	Signal	Note
26	Ground	
27	Ground	
28	+1.5V	
29	Ground	
30	SMB_CLK	
31	PETn0	
32	SMB_DATA	
33	PETp0	
34	Ground	
35	Ground	
36	USB_D-	
37	Ground	
38	USB_D+	
39	+3.3VSB	
40	Ground	
41	+3.3VSB	
42	LED_WWAN#	
43	Ground	
44	LED_WLAN#	
45	Reserved	
46	LED_WPAN#	
47	Reserved	
48	+1.5V	
49	Reserved	
50	Ground	
51	Reserved	
52	+3.3VSB	



* These pins are connected to CN10 SIM Interface directly.

7.14. SIM Interface Wafer for MPCIE1 (CN10)

Figure 28: SIM Interface Wafer CN10

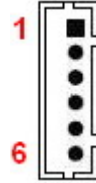

Table 43: Pin Assignment CN10

Pin	Signal	Description	Note
1	UIM_PWR	Power +5V or +3.3V	
2	UIM_DATA	Input or Output for serial data	
3	UIM_RESET	Reset signal	
4	UIM_VPP	Programming voltage input (optional)	
5	UIM_CLK	Clock signal	
6	GND	Ground	

7.15. mSATA Socket (MSATA1)

Full-sized mSATA socket (MSATA1). The mSATA interface complies with SATA 2.0.

Figure 29: Serial ATA Port-1 mSATA Socket MSATA1

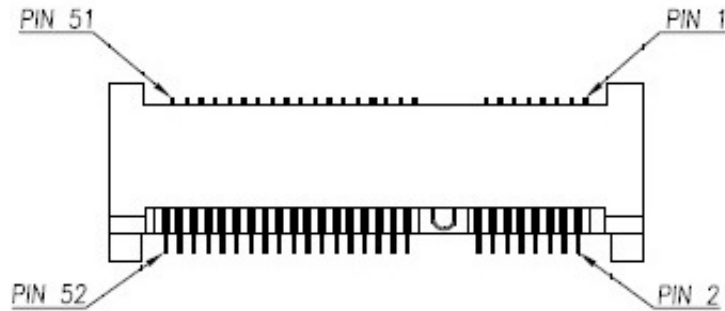

Table 44: Pin Assignment MSATA1

Pin	Signal	Note
1	NC	
2	+3.3V	
3	NC	
4	Ground	
5	NC	
6	NC	
7	N/A	
8	NC	
9	Ground	
10	NC	
11	NC	
12	NC	
13	NC	
14	NC	
15	Ground	
16	NC	
17	NC	
18	Ground	
19	NC	
20	NC	
21	Ground	
22	NC	
23	SATA_RX+	
24	+3.3V	
25	SATA_RX-	
26	Ground	

Pin	Signal	Note
27	Ground	
28	NC	
29	Ground	
30	NC	
31	SATA_TX-	
32	NC	
33	SATA_TX+	
34	Ground	
35	Ground	
36	NC	
37	Ground	
38	NC	
39	+3.3V	
40	Ground	
41	+3.3V	
42	NC	
43	Ground	
44	NC	
45	NC	
46	NC	
47	NC	
48	NC	
49	NC	
50	Ground	
51	NC	
52	+3.3V	

7.16. PS/2 Keyboard and Mouse Wafer (CN2)

Attachment of a PS/2 keyboard / mouse can be done through the pinrow connector CN2.

Figure 30: PS/2 Keyboard / Mouse Wafer CN2

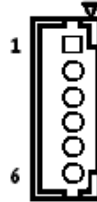

Table 45: Pin Assignment CN2

Pin	Signal	Note
1	MSCLK	
2	VCC	
3	MSDAT	
4	KBDAT	
5	GND	
6	KBCLK	

Table 46: Signal Description

Signal	Description
MSCLK	Bi-directional clock signal used to strobe data/commands from/to the PS/2 mouse.
MSDAT	Bi-directional serial data line used to transfer data from or commands to the PS/2 mouse.
KBCLK	Bi-directional clock signal used to strobe data/commands from/to the PC-AT keyboard.
KBDAT	Bi-directional serial data line used to transfer data from or commands to the PC-AT keyboard.

7.17. Switches and Jumpers

The product has several jumpers which must be properly configured to ensure correct operation.

Figure 31: Jumper Connector

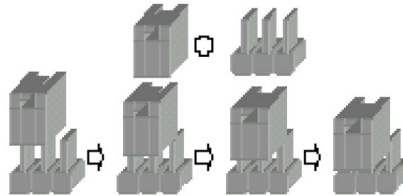

For a three-pin jumper (see Figure 35), the jumper setting is designated "1-2" when the jumper connects pins 1 and 2. The jumper setting is designated "2-3" when pins 2 and 3 are connected and so on. You will see that one of the lines surrounding a jumper pin is thick, which indicates pin No.1.

To move a jumper from one position to another, use needle-nose pliers or tweezers to pull the pin cap off the pins and move it to the desired position.

7.17.1. RTC Reset Selection (JP1)

The "RTC Reset" jumper (JP1) can be used to reset the Real Time Clock (RTC) and drain RTC well.

The jumper has one position: Pin 1-2 and not mounted (default position). More information on setting the "RTC Reset" jumper can be found in the following table.

Figure 32: RTC Reset Selection JP1

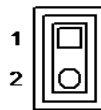

Table 47: Pin Assignment JP1

Jumper Position	Description
Pin 1-2	
X	Enable Clear CMOS RTC content (board does not boot with the jumper in this position)
-	Normal operation (default position)

"X" = Jumper set (short) and "-" = jumper not set (open)



Do not leave the jumper in position 1-2, otherwise if the power is disconnected, the battery will fully deplete within a few weeks.

7.17.2. MPCIE1 Activity LED Indication (JP2)

Figure 33: MPCIE1 Activity LED Indication JP2

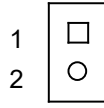

Table 48: Pin Assignment JP2

Pin	Signal	Note
1	LED+	
2	LED-	

7.17.3. Backlight Enable Selection for LVDS1 (JP4)

Figure 34: Backlight Enable Selection JP4

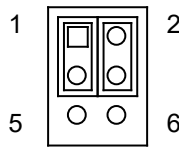

Table 49: Pin Assignment JP4

Jumper 1 Position		Description
Pin 1-3	Pin 3-5	
X	-	Backlight Enable Voltage = +3.3V
-	X	Backlight Enable Voltage = +5V
Jumper 2 Position		Description
Pin 2-4	Pin 4-6	
X	-	Active High
-	X	Active Low

"X" = Jumper set (short) and "-" = jumper not set (open)

7.17.4. Panel & Backlight Power Selection for LVDS1 (JP5)

Figure 35: Panel & Backlight Power Selection JP5

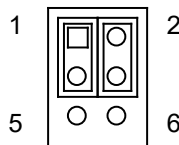

Table 50: Pin Assignment JP5

Jumper 1 Position		Description
Pin 1-3	Pin 3-5	
X	-	Backlight Power = +12V
-	X	Backlight Power = +5V
Jumper 2 Position		Description
Pin 2-4	Pin 4-6	
X	-	Panel Power = +3,3V
-	X	Panel Power = +5V

"X" = Jumper set (short) and "-" = jumper not set (open)

7.17.5. USB Power Selection (JP6)

Figure 36: USB Power Selection JP6

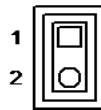

Table 51: Pin Assignment JP6

Jumper Position		Description
Pin 1-2		
X		USB power is always supply.
-		USB power will be cut off in S4 & S5 state.

"X" = Jumper set (short) and "-" = jumper not set (open)

7.17.6. AT / ATX Power Mode Selection (JP7)

Figure 37: AT / ATX Power Mode Selection JP7

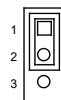

Table 52: Pin Assignment JP7

Jumper 1 Position		Description
Pin 1-2	Pin 2-3	
X	-	ATX Mode
-	X	AT Mode

"X" = Jumper set (short) and "-" = jumper not set (open)

7.17.7. ME F/W Selection (JP8)

Figure 38: ME F/W Selection JP8

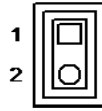

Table 53: Pin Assignment JP8

Jumper Position	Description
Pin 1-2	
X	ME F/W Disabled
-	Normal Operation

"X" = Jumper set (short) and "-" = jumper not set (open)

8/ On-Board Connectors & Mating Connector Types

The Mating connectors / Cables are connectors or cable kits which are fitting the On-board connector.

The cable kits marked with "*" are included in the "ECX-BYT Cable & Driver Kit".

Table 54: On-Board Connectors & Mating Connector Types

Connector	On-Board Connectors		Mating Connectors / Cables	
	Manufact.	Type No.	Manufact.	Type No.
Battery Input (BAT1)	Pinrex	712-73-02TWR0		
COM (COM1 ~ COM6)	Pinrex	712-73-10TWB0		0C5020000000910L
DC 12V Power Input (CN1)	Pinrex	733-97-04TBR1		0C5020000001580L
Keyboard/Mouse (CN2)	YIMTEX	503PW1*06ST-1R		0C5020002500010L
HDD Power Output (CN3)	Pinrex	721-93-04TWE9		0C5020000001590L
Audio Input / Output (CN9)	Pinrex	212-92-06GBE1		0C5020000002050L
SIM (CN10)	Pinrex	712-73-06TWB0		0ZHK12003GSIM003
Audio AMP (CN11, CN12)	YIMTEX	503PW1*02STR & 503PW1*02ST-1R		
DIO (CN13)	Pinrex	712-73-10TWB0		0C5020000002060L
Backlight Power (CN16)	Townes Enterprise	1250W-07T1-V		
FAN (FAN1)	Pinrex	712-73-03TWE0		
Front Panel (FP1)	YIMTEX	3362*04SANGR		
Front Panel (FP2)	YIMTEX	3362*05SANGR		
LVDS Panel (LVDS1)	JAE	JS-1267-30(G1)NH		
mPCIe (MPCIE1)	FOXCONN	A50B226-S99Q-7H		
mSATA (MSATA1)	LOTES	AAA-PCI-093-K01		
SATA (SATA1)	FOXCONN	LD1807V-S52U		0C5020000004240L
USB 2.0 (CN15)	Pinrex	712-73-04TWE0		0C5020000003220L
USB 2.0 (CN16)	YIMTEX	3362*05SANGR-09		0C502USB0201010L



Please note that standard connectors like DP, mPCIe, Audio Jack, Ethernet and USB are not included in the list.

9/ BIOS

9.1. Starting the uEFI BIOS

The ECX-BYT is provided with a Kontron-customized, pre-installed and configured version of AMI Aptio® V uEFI BIOS. AMI BIOS firmware is based on the Unified Extensible Firmware Interface (UEFI) specification and the Intel® Platform Innovation Framework for EFI. This uEFI BIOS provides a variety of new and enhanced functions specifically tailored to the hardware features of the ECX-BYT.

The uEFI BIOS comes with a setup program that provides quick and easy access to the individual function settings for control or modification of the uEFI BIOS configuration. The setup program allows the accessing of various menus that provide functions or access to sub-menus with more specific functions of their own.

To start the uEFI BIOS setup program, follow the steps below:

1. Power on the board.
2. Wait until the first characters appear on the screen (POST messages or splash screen).
3. Press the key.
4. If the uEFI BIOS is password-protected, a request for password will appear. Enter either the User Password or the Supervisor Password (see Security menu), press <RETURN>, and proceed with step 5.
5. A setup menu will appear.

The ECX-BYT uEFI BIOS setup program uses a hot key-based navigation system. A hot key legend bar is located on the bottom of the setup screens.

The following table provides information concerning the usage of these hot keys.

Table 55: Font Size Table

Hotkeys	Description
<F1>	The <F1> key invokes the General Help window.
<->	The <Minus> key selects the next lower value within a field.
<+>	The <Plus> key selects the next higher value within a field.
<F2>	The <F2> key loads the previous values.
<F3>	The <F3> key loads the standard default values.
<F4>	The <F4> key saves the current settings and exit the uEFI BIOS setup.
<→> or <←>	The <Left/Right> arrows selects major setup menus on the menu bar. For example: Main, Advanced, Security, etc.
<↑> or <↓>	The <Up/Down> arrows selects fields in the current menu. For example: A setup function or a sub-screen.
<ESC>	The <ESC> key exits a major setup menu and enter the Exit setup menu. Pressing the <ESC> key in a sub-menu displays the next higher menu level.
<RERURN>	The <RETURN> key executes a command or select a submenu.

9.2. Setup Menus

The Setup utility features shows six menus in the selection bar at the top of the screen:

- ▶ Main
- ▶ Advanced
- ▶ Power
- ▶ Boot
- ▶ Security
- ▶ Save & Exit

The Setup menus are selected via the left and right arrow keys. The currently active menu and the currently active uEFI BIOS Setup item are highlighted in white. Each Setup menu provides two main frames. The left frame displays all available functions. Functions that can be configured are displayed in blue. Functions displayed in gray provide information about the status or the operational configuration. The right frame displays an Item Specific Help window providing an explanation of the respective function.

9.2.1. Main Setup Menu

Upon entering the uEFI BIOS Setup program, the Main Setup menu is displayed. This screen lists the Main Setup menu sub-screens and provides basic system information. Additionally functions for setting the system time and date are offered.

Table 56: Main Setup Menu Sub-Screens and Functions

Function	Description
BIOS Information	Read only field. Displays information about the system BIOS
Memory Information	Read only field. Displays information about total memory
ME Information	Read only field. Displays information about Intel Management Engine (ME) version
TXE Information	Read only field. Displays information about TXE information
Firmware Information	Code version and firmware information
System Date	Set System Date
System Time	Set System Time

Figure 39: BIOS Main Menu Screen System Data and Time

BIOS SETUP UTILITY					
Main	Advanced	Power	Boot	Security	Save & Exit
Product Information					
Product Name		ECX-BYT-J1900			
BIOS Version		R0.0A (x64)			
BIOS Build Date		05/26/2014			
ME FW Version		01.01.00.1089			
CPU Information					
Intel® Celeron® CPU J1900 @ 1.99GHz					
Microcode Revision		809			
Processor Cores		4		→ ←: Select Screen	
Memory Information					
Total Size		4069 MB (DDR3L)		↑ ↓: Select Item	
Frequency		1333 MHz		Enter: Select	
System Date		[Mon 05/26/2014]		+/-: Change Opt.	
System Time		[13:23:12]		F1: General Help	
Access Level		Administrator		F2: Previous Values	
				F3: Optimized Defaults	
				F4: Save & Exit	
				ESC: Exit	
Version 2.16.1242. Copyright (C) 2013, American Megatrends, Inc.					

Feature	Option	Description
System Date	[dd/mm/yyyy]	Set the Date. Use Tab to switch between Data elements.
System Time	[hh:mm:ss]	Set the Time. Use Tab to switch between Time elements.

9.2.2. Advanced Setup Menu

The Advanced setup menu provides sub-screens and functions for advanced configurations. The following sub-screen functions are included in the menu:

- ▶ LAN & Audio Configuration
- ▶ Display Configuration
- ▶ Super IO Configuration
- ▶ CPU Chipset Configuration
- ▶ SATA Configuration
- ▶ USB Configuration
- ▶ DIO Configuration
- ▶ H/W Monitor

NOTICE

Setting items on this screen to incorrect values may cause the system to malfunction.

Figure 40: BIOS Advanced Menu

BIOS SETUP UTILITY					
Main	Advanced	Power	Boot	Security	Save & Exit
Onboard LAN1 Controller		[Enabled]			
Onboard LAN1 Boot		[Disabled]			
Onboard LAN2 Controller		[Enabled]			
Onboard LAN2 Boot		[Disabled]			
Audio Controller		[Enabled]			
> Display Configuration					
> Super IO Configuration					
> CPU Chipset Configuration					
> SATA Configuration					
> USB Configuration					
> DIO Configuration					
> H/W Monitor					
				→ ←: Select Screen	
				↑ ↓: Select Item	
				Enter: Select	
				+/-: Change Opt.	
				F1: General Help	
				F2: Previous Values	
				F3: Optimized Defaults	
				F4: Save & Exit	
				ESC: Exit	
Version 2.16.1242. Copyright (C) 2013, American Megatrends, Inc.					

Feature	Option	Description
Onboard LAN1 Controller	[Disabled], [Enabled]	Select whether to enable or disable Onboard LAN1 Controller.
Onboard LAN1 Boot	[Disabled], [Enabled]	Select whether to enable or disable load onboard PXE (Preboot Execution Environment).
Onboard LAN2 Controller	[Disabled], [Enabled]	Select whether to enable or disable Onboard LAN2 Controller.
Onboard LAN2 Boot	[Disabled], [Enabled]	Select whether to enable or disable load onboard PXE (Preboot Execution Environment).
Audio Controller	[Disabled], [Enabled]	Select whether to enable or disable Audio Controller.

Figure 41: BIOS Advanced Menu - Display Configuration

BIOS SETUP UTILITY					
Main	Advanced	Power	Boot	Security	Save & Exit
Display Configuration					
Primary Display		[Auto]			
UWA Frame Buffer Size		[256MB]		→ ←: Select Screen	
DVMT Pre-Allocated		[64M]		↑ ↓: Select Item	
DVMT Total Gfx Mem		[256M]		Enter: Select	
Primary IGFX Boot Display		[VBIOS Default]		+/-: Change Opt.	
Active LVDS		[Disabled]		F1: General Help	
LVDS Panel Type*		[1024x768 18Bit 1CH]		F2: Previous Values	
LVDS Backlight Control Mode*		[PWM]		F3: Optimized Defaults	
LVDS Backlight Control - Voltage*		[3.5V]		F4: Save & Exit	
				ESC: Exit	
Version 2.16.1242. Copyright (C) 2013, American Megatrends, Inc.					

* These items appear only when enabling Active LVDS.

Feature	Option	Description
Primary Display	[Auto], [IGD]	Select which graphic controller to be used as the primary display device.
UWA Frame Buffer Size	[128MB], [256MB], [512MB]	Select the Aperture Size.
DVMT Pre-Allocated	[64M], [96M], [128M], [160M], [192M], [224M], [256M], [288M], [320M], [352M], [384M], [416M], [448M], [480M], [512M]	Select DVMT Pre-Allocated (Fixed) Graphics Memory size used by the Internal Graphics Device.
DVMT Total Gfx Mem	[128M], [256M], [MAX]	Select DVMT Total Graphic Memory size used by the Internal Graphics Device.
Primary IGFX Boot Display	[VBIOS Default], [CRT], [HDMI], [LVDS]	Select the Video Device which will be activated during POST. This has no effect if external graphics present. Secondary boot display selection will appear based on your selection. DOS modes will be supported only on primary display.
Active LVDS	[Disabled], [Enabled]	Select the Active LVDS Configuration. [Disabled]: VBIOS does not enable LVDS. [Enabled]: VBIOS will enable LVDS.
LVDS Panel Type	[640x480 18Bit 1CH], [800x480 18Bit 1CH], [800x600 18Bit 1CH], [1024x768 18Bit 1CH], [1440x900 18Bit 1CH], [1600x900 18Bit 1CH]	Select the appropriate setup item for LVDS panel.
LVDS Backlight	[Voltage], [PWM]	Select the appropriate setup item for LVDS backlight control

Feature	Option	Description
Control Mode		mode.
LVDS Backlight Control - Voltage	[0.0V], [0.5V], [1.0V], [1.5V], [2.0V], [3.0V], [3.5V], [4.0V], [4.5V], [5.0V]	Select the voltage of LVDS backlight control mode.

Figure 42: BIOS Advanced Menu - Super IO Configuration

BIOS SETUP UTILITY					
Main	Advanced	Power	Boot	Security	Save & Exit
Super IO Configuration					
> Serial Port 1 Configuration > Serial Port 2 Configuration > Serial Port 3 Configuration > Serial Port 4 Configuration > Serial Port 5 Configuration > Serial Port 6 Configuration				→ ←: Select Screen ↑ ↓: Select Item Enter: Select +/-: Change Opt. F1: General Help F2: Previous Values F3: Optimized Defaults F4: Save & Exit ESC: Exit	
Version 2.16.1242. Copyright (C) 2013, American Megatrends, Inc.					

Figure 43: BIOS Advanced Menu - Super IO Configuration - Serial Port 1 Configuration

BIOS SETUP UTILITY					
Main	Advanced	Power	Boot	Security	Save & Exit
Serial Port 1 Configuration					
Serial Port		[Enabled]		→ ←: Select Screen ↑ ↓: Select Item Enter: Select +/-: Change Opt. F1: General Help F2: Previous Values F3: Optimized Defaults F4: Save & Exit ESC: Exit	
Device Settings		IO=3F8h; IRQ=4;			
Change Setting		[Auto]			
Serial Port 1 Type		[RS232]			
RS485 Deplx Mode*		[Half Duplex]			
Version 2.16.1242. Copyright (C) 2013, American Megatrends, Inc.					

* These items appear only when selecting RS485 for the Serial Port 1 Type.

Feature	Option	Description
Serial Port	[Disabled], [Enabled]	Select whether to enable or disable Serial Port (COM).
Change Settings	[Auto], [IO=3F8h; IRQ=4;], [IO=3F8h; IRQ=3, 4, 5, 6, 7, 9, 10, 11, 12;], [IO=2F8h; IRQ=3, 4, 5, 6, 7, 9, 10, 11, 12;], [IO=3E8h; IRQ=3, 4, 5, 6, 7, 9, 10, 11, 12;], [IO=2E8h; IRQ=3, 4, 5, 6, 7, 9, 10, 11, 12;]	Select an optional setting for Super IO device.

Feature	Option	Description
Serial Port 1 Type	[RS232], [RS422], [RS485]	Select an appropriate type for Serial Port 1.
RS485 Duplex Mode	[Half Duplex], [Full Duplex]	Select an appropriate RS485 Duplex Mode.

Figure 44: BIOS Advanced Menu - Super IO Configuration - Serial Port 2 Configuration

BIOS SETUP UTILITY					
Main	Advanced	Power	Boot	Security	Save & Exit
Serial Port 2 Configuration					
Serial Port		[Enabled]		→ ←: Select Screen	
Device Settings		IO=2F8h; IRQ=3;		↑ ↓: Select Item	
Change Setting		[Auto]		Enter: Select	
Serial Port 2 Type		[RS232]		+/-: Change Opt.	
RS485 Deplx Mode*		[Half Duplex]		F1: General Help	
				F2: Previous Values	
				F3: Optimized Defaults	
				F4: Save & Exit	
				ESC: Exit	
Version 2.16.1242. Copyright (C) 2013, American Megatrends, Inc.					

* These items appear only when selecting RS485 for the Serial Port 2 Type.

Feature	Option	Description
Serial Port	[Disabled], [Enabled]	Select whether to enable or disable Serial Port (COM).
Change Settings	[Auto], [IO=2F8h; IRQ=3;], [IO=3F8h; IRQ=3, 4, 5, 6, 7, 9, 10, 11, 12;], [IO=2F8h; IRQ=3, 4, 5, 6, 7, 9, 10, 11, 12;], [IO=3E8h; IRQ=3, 4, 5, 6, 7, 9, 10, 11, 12;], [IO=2E8h; IRQ=3, 4, 5, 6, 7, 9, 10, 11, 12;]	Select an optional setting for Super IO device.
Serial Port 2 Type	[RS232], [RS422], [RS485]	Select an appropriate type for Serial Port 2.
RS485 Duplex Mode	[Half Duplex], [Full Duplex]	Select an appropriate RS485 Duplex Mode.

Figure 45: BIOS Advanced Menu - Super IO Configuration - Serial Port 3 Configuration

BIOS SETUP UTILITY					
Main	Advanced	Power	Boot	Security	Save & Exit
Serial Port 3 Configuration					
Serial Port		[Enabled]		→ ←: Select Screen ↑ ↓: Select Item Enter: Select +/-: Change Opt. F1: General Help F2: Previous Values F3: Optimized Defaults F4: Save & Exit ESC: Exit	
Device Settings		IO=3E8h; IRQ=7;			
Change Setting		[Auto]			
Version 2.16.1242. Copyright (C) 2013, American Megatrends, Inc.					

Feature	Option	Description
Serial Port	[Disabled], [Enabled]	Select whether to enable or disable Serial Port (COM).
Change Settings	[Auto], [IO=3E8h; IRQ=7;], [IO=3E8h; IRQ=3, 4, 5, 6, 7, 9, 10, 11, 12;], [IO=2E8h; IRQ=3, 4, 5, 6, 7, 9, 10, 11, 12;], [IO=2F0h; IRQ=3, 4, 5, 6, 7, 9, 10, 11, 12;], [IO=2E0h; IRQ=3, 4, 5, 6, 7, 9, 10, 11, 12;]	Select an optional setting for Super IO device.

Figure 46: BIOS Advanced Menu - Super IO Configuration - Serial Port 4 Configuration

BIOS SETUP UTILITY					
Main	Advanced	Power	Boot	Security	Save & Exit
Serial Port 4 Configuration					
Serial Port		[Enabled]		→ ←: Select Screen ↑ ↓: Select Item Enter: Select +/-: Change Opt. F1: General Help F2: Previous Values F3: Optimized Defaults F4: Save & Exit ESC: Exit	
Device Settings		IO=2E8h; IRQ=7;			
Change Setting		[Auto]			
Version 2.16.1242. Copyright (C) 2013, American Megatrends, Inc.					

Feature	Option	Description
Serial Port	[Disabled], [Enabled]	Select whether to enable or disable Serial Port (COM).
Change Settings	[Auto], [IO=2E8h; IRQ=7;], [IO=3F8h; IRQ=3, 4, 5, 6, 7, 9, 10, 11, 12;], [IO=2F8h; IRQ=3, 4, 5, 6, 7, 9, 10, 11, 12;], [IO=3E8h; IRQ=3, 4, 5, 6, 7, 9, 10, 11, 12;], [IO=2E8h; IRQ=3, 4, 5, 6, 7, 9, 10, 11, 12;], [IO=2F0h; IRQ=3, 4, 5, 6, 7, 9, 10, 11, 12;], [IO=2E0h; IRQ=3, 4, 5, 6, 7, 9, 10, 11, 12;]	Select an optional setting for Super IO device.

Figure 47: BIOS Advanced Menu - Super IO Configuration - Serial Port 5 Configuration

BIOS SETUP UTILITY					
Main	Advanced	Power	Boot	Security	Save & Exit
Serial Port 5 Configuration					
Serial Port		[Enabled]		→ ←: Select Screen	
Device Settings		IO=2F0h; IRQ=7;		↑ ↓: Select Item	
Change Setting		[Auto]		Enter: Select	
				+/-: Change Opt.	
				F1: General Help	
				F2: Previous Values	
				F3: Optimized Defaults	
				F4: Save & Exit	
				ESC: Exit	
Version 2.16.1242. Copyright (C) 2013, American Megatrends, Inc.					

Feature	Option	Description
Serial Port	[Disabled], [Enabled]	Select whether to enable or disable Serial Port (COM).
Change Settings	[Auto], [IO=2F0h; IRQ=7;], [IO=3E8h; IRQ=3, 4, 5, 6, 7, 9, 10, 11, 12;], [IO=2E8h; IRQ=3, 4, 5, 6, 7, 9, 10, 11, 12;], [IO=2F0h; IRQ=3, 4, 5, 6, 7, 9, 10, 11, 12;], [IO=2E0h; IRQ=3, 4, 5, 6, 7, 9, 10, 11, 12;]	Select an optional setting for Super IO device.

Figure 48: BIOS Advanced Menu - Super IO Configuration - Serial Port 6 Configuration

BIOS SETUP UTILITY					
Main	Advanced	Power	Boot	Security	Save & Exit
Serial Port 6 Configuration					
Serial Port		[Enabled]		→ ←: Select Screen ↑ ↓: Select Item Enter: Select +/-: Change Opt. F1: General Help F2: Previous Values F3: Optimized Defaults F4: Save & Exit ESC: Exit	
Device Settings		IO=2E0h; IRQ=7;			
Change Setting		[Auto]			
Version 2.16.1242. Copyright (C) 2013, American Megatrends, Inc.					

Feature	Option	Description
Serial Port	[Disabled], [Enabled]	Select whether to enable or disable Serial Port (COM).
Change Settings	[Auto], [IO=2E0h; IRQ=7;], [IO=3E8h; IRQ=3, 4, 5, 6, 7, 9, 10, 11, 12;], [IO=2E8h; IRQ=3, 4, 5, 6, 7, 9, 10, 11, 12;], [IO=2F0h; IRQ=3, 4, 5, 6, 7, 9, 10, 11, 12;], [IO=2E0h; IRQ=3, 4, 5, 6, 7, 9, 10, 11, 12;]	Select an optional setting for Super IO device.

Figure 49: BIOS Advanced Menu - CPU Chipset Configuration

BIOS SETUP UTILITY					
Main	Advanced	Power	Boot	Security	Save & Exit
CPU Chipset Configuration					
EIST		[Enabled]		→ ←: Select Screen	
Limit CPUID Maximum		[Disabled]		↑ ↓: Select Item	
Execute Disable Bit		[Enabled]		Enter: Select	
Intel Virtualization Technology		[Disabled]		+/-: Change Opt.	
				F1: General Help	
				F2: Previous Values	
				F3: Optimized Defaults	
				F4: Save & Exit	
				ESC: Exit	
Version 2.16.1242. Copyright (C) 2013, American Megatrends, Inc.					

Feature	Option	Description
EIST	[Disabled], [Enabled]	Select whether to enable or disable Enhanced Intel SpeedStep Technology.
Limit CPUID Maximum	[Disabled], [Enabled]	Select whether to limit CPUID maximum value.
Execute Disable Bit	[Disabled], [Enabled]	Select whether to enable or disable Execute Disable Bit functionality, which prevents malicious buffer overflow attacks..
Intel Virtualization Technology	[Disabled], [Enabled]	Select whether to enable or disable Intel Virtualization Technology.

Figure 50: BIOS Advanced Menu - SATA Configuration

BIOS SETUP UTILITY					
Main	Advanced	Power	Boot	Security	Save & Exit
SATA Controller(s)					
Serial-ATA (SATA)		[Enabled]	→ ←: Select Screen		
SATA Mode		[AHCI Mode]	↑ ↓: Select Item		
Serial ATA Port 1		Empty	Enter: Select		
Port 1		[Enabled]	+/-: Change Opt.		
mS ATA Port 1		Empty	F1: General Help		
Port 1		[Enabled]	F2: Previous Values		
			F3: Optimized Defaults		
			F4: Save & Exit		
			ESC: Exit		
Version 2.16.1242. Copyright (C) 2013, American Megatrends, Inc.					

Feature	Option	Description
Serial-ATA(SATA)	[Enabled], [Disabled]	Select whether to enable or disable SATA Device.
SATA Mode	[IDE Mode], [AHCI Mode]	Determine how SATA controller(s) operate.
Port 1	[Disabled], [Enabled]	Select whether to enable or disable SATA Port 1 or mSATA Port 1.

Figure 51: BIOS Advanced Menu - USB Configuration

BIOS SETUP UTILITY					
Main	Advanced	Power	Boot	Security	Save & Exit
USB Configuration					
USB Devices: 1 Keyboard, 2 Hubs				→ ←: Select Screen ↑ ↓: Select Item Enter: Select +/-: Change Opt. F1: General Help F2: Previous Values F3: Optimized Defaults F4: Save & Exit ESC: Exit	
Legacy USB Support		[Enabled]			
XHCI Legacy Support		[Enabled]			
XHCI Hand-off		[Enabled]			
EHCI Hand-off		[Disabled]			
USB Mass Storage Driver Support		[Enabled]			
XHCI Mode		[Smart Auto]			
Version 2.16.1242. Copyright (C) 2013, American Megatrends, Inc.					

Feature	Option	Description
Legacy USB Support	[Enabled], [Disabled], [Auto]	Select whether to enable or disable Legacy USB support. AUTO option disables legacy support if no USB devices are connected.
XHCI Legacy Support	[Disabled], [Enabled]	Select whether to enable or disable XHCI Controller Legacy support.
XHCI Hand-off	[Enabled], [Disabled]	Select whether to enable or disable XHCI Hand-off function. This is a workaround for OSes without XHCI hand-off support. The XHCI ownership change should be claimed by XHCI driver.
EHCI Hand-off	[Disabled], [Enabled]	Select whether to enable or disable EHCI Hand-off function.
USB Mass Storage Driver Support	[Disabled], [Enabled]	Select whether to enable or disable USB Mass Storage Driver Support.
XHCI Mode	[Smart Auto], [Enabled]	Determine the operating mode of the XHCI controller in OS.

Figure 52: BIOS Advanced Menu - DIO Configuration

BIOS SETUP UTILITY					
Main	Advanced	Power	Boot	Security	Save & Exit
DIO Configuration					
DIO-0		[Output Low]			
DIO-1		[Output Low]			
DIO-2		[Output Low]			
DIO-3		[Output Low]			
DIO-4		[Output Low]			
DIO-5		[Output Low]			
DIO-6		[Output Low]			
DIO-7		[Output Low]			
DIO-0 Value		1		→ ←: Select Screen	
DIO-1 Value		1		↑ ↓: Select Item	
DIO-2 Value		1		Enter: Select	
DIO-3 Value		1		+/-: Change Opt.	
DIO-4 Value		1		F1: General Help	
DIO-5 Value		1		F2: Previous Values	
DIO-6 Value		1		F3: Optimized Defaults	
DIO-7 Value		1		F4: Save & Exit	
				ESC: Exit	
Version 2.16.1242. Copyright (C) 2013, American Megatrends, Inc.					

Feature	Option	Description
DIO-0..7	[Output Low], [Output High], [Input]	Set up the DIO pin input / output value.

Figure 53: BIOS Advanced Menu - H/W Monitor

BIOS SETUP UTILITY					
Main	Advanced	Power	Boot	Security	Save & Exit
PC Health Status					
CPU Warning Temperature		[Disabled]			
> CPU FAN Configuration					
CPU Temperature		: +40 C		→ ←: Select Screen ↑ ↓: Select Item Enter: Select +/-: Change Opt. F1: General Help F2: Previous Values F3: Optimized Defaults F4: Save & Exit ESC: Exit	
System Temperature		: +39 C			
CPU Fan Speed		: N/A			
+VCORE		: +0.773 V			
+VIN		: +12.268 V			
+5V		: +5.066 V			
+VMEN		: +1.357 V			
Version 2.16.1242. Copyright (C) 2013, American Megatrends, Inc.					

Feature	Option	Description
CPU Warning Temperature	[Disabled], [80], [85], [90], [95]	Determine whether to enable or disable CPU Warning Temperature function and select a temperature that will sound an alarm.

BIOS SETUP UTILITY					
Main	Advanced	Power	Boot	Security	Save & Exit
CPU FAN Configuration					
FAN Setting		[Manual Mode]		→ ←: Select Screen ↑ ↓: Select Item Enter: Select +/-: Change Opt. F1: General Help F2: Previous Values F3: Optimized Defaults F4: Save & Exit ESC: Exit	
Manual Duty		255			
Version 2.16.1242. Copyright (C) 2013, American Megatrends, Inc.					

Feature	Option	Description
FAN Setting	[Manual Mode], [Auto Mode]	Switch the CPU FAN control mode.

9.2.3. Power Setup Menu

The Power setup menu provides functions and a sub-screen for power configurations. The following sub-screen function is included in the menu:

- ▶ WatchDog Timer Configuration

Figure 54: BIOS Power Setup Menu

BIOS SETUP UTILITY					
Main	Advanced	Power	Boot	Security	Save & Exit
Power Management Configuration					
ACPI Sleep State		[S3 (Suspend to RAM)]			
Restore AC Power Loss		[Power Off]			
Power Saving Mode		[Disabled]		→ ←: Select Screen	
Resume Event Control				↑ ↓: Select Item	
Resume From S3 By PS/2 Keyboard		[Disabled]		Enter: Select	
Resume From S3 By PS/2 Mouse		[Disabled]		+/-: Change Opt.	
Resume By PCIE Device		[Disabled]		F1: General Help	
Resume By Ring Device		[Disabled]		F2: Previous Values	
Resume By RTC Alarm		[Disabled]		F3: Optimized Defaults	
> WatchDog Timer Configuration				F4: Save & Exit	
				ESC: Exit	
Version 2.16.1242. Copyright (C) 2013, American Megatrends, Inc.					

Feature	Option	Description
ACPI Sleep State	[Suspend Disabled], [S1 (CPU Stop Clock)], [S3 (Suspend to RAM)]	Select whether to enable or disable suspend function and determine an appropriate suspend mode.
Restore AC Power Loss	[Power Off], [Power On], [Last State]	Control whether the system will stay on after AC power is removed and then restored. Select [Power Off] if you want the system to remain off after power restored. Select [Power On] if you use a power strip to turn the system on.
Power Saving Mode	[Disabled], [Enabled]	Select whether to enable Power Saving Mode.
Resume From S3 By PS/2 Keyboard	[Enabled], [Disabled]	Select whether to allow waking the system up from the S3 sleep state by PS/2 keyboard.
Resume From S3 By PS/2 Mouse	[Enabled], [Disabled]	Select whether to allow waking the system up from the S3 sleep state by PS/2 mouse.
Resume By PCIE Device	[Disabled], [Enabled]	Select whether to enable or disable Wake from PCIE Device.
Resume By Ring Device	[Disabled], [Enabled]	Select whether to enable or disable Wake from Ring Device.
Resume By RTC Alarm	[Disabled], [Enabled]	Select whether to enable or disable Wake Up on Alarm, to turn on your system on a special day of the month.

Figure 55: BIOS Power Setup Menu - WatchDog Timer Configuration

BIOS SETUP UTILITY					
Main	Advanced	Power	Boot	Security	Save & Exit
WatchDog Timer Configuration					
WDT Function		[Disabled]		→ ←: Select Screen ↑ ↓: Select Item Enter: Select +/-: Change Opt. F1: General Help F2: Previous Values F3: Optimized Defaults F4: Save & Exit ESC: Exit	
Version 2.16.1242. Copyright (C) 2013, American Megatrends, Inc.					

Feature	Option	Description
WDT Function	[Disabled], [Enabled]	Select whether to enable or disable WatchDog Timer function.

9.2.4. Boot Setup Menu

The boot setup menu lists the for boot device priority order, that is generated dynamically.

Figure 56: BIOS Boot Setup Menu

BIOS SETUP UTILITY					
Main	Advanced	Power	Boot	Security	Save & Exit
Boot Configuration					
Full Screen LOGO Display		[Disabled]			
Setup Prompt Timeout		1		→ ←: Select Screen	
Bootup NumLock State		[On]		↑ ↓: Select Item	
Keyboard Detect Warning		[Enabled]		Enter: Select	
CSM Support		[Enabled]		+/-: Change Opt.	
Boot Option Filter		[Legacy Only]		F1: General Help	
Boot Option Priorities				F2: Previous Values	
				F3: Optimized Defaults	
				F4: Save & Exit	
				ESC: Exit	
Version 2.16.1242. Copyright (C) 2013, American Megatrends, Inc.					

Feature	Option	Description
Full Screen LOGO Display	[Disabled], [Enabled]	Select whether to enable or disable to display logo screen.
Bootup NumLock State	[On], [Off]	Select the state of the NumLock feature of the keyboard after Startup. [On]: The keys on the keypad will act as numeric keys. [Off]: The keys on the keypad will act as cursor keys.
Keyboard Detect Warning	[Disabled], [Enabled]	Select whether to enable or disable Keyboard Detect Warning function.
CSM Support	[Enabled], [Disabled]	Select whether to enable or disable CSM support.
Boot Option Filter	[UEFI and Legacy], [Legacy only], [UEFI only]	Control Legacy / UEFI ROMs priority.

9.2.5. Security Setup Menu

The Security setup menu provides information about the passwords and functions for specifying the security settings. The passwords are case-sensitive. The ECX-BYT provides no factory-set passwords.

NOTICE

If there is already a password installed, the system asks for this first. To clear a password, simply enter nothing and acknowledge by pressing <RETURN>. To set a password, enter it twice and acknowledge by pressing <RETURN>.

Figure 57: BIOS Boot Setup Menu

BIOS SETUP UTILITY					
Main	Advanced	Power	Boot	Security	Save & Exit
Password Description					
If ONLY the Administrator's password is set, then this only limits access to Setup and is only asked for when entering Setup					
If ONLY the User's password is set, then this is a power on password and must be entered to boot or enter Setup. In Setup the User will have Administrator rights					
The password length must be in the following range:				→ ←: Select Screen	
Minimum Length		3		↑ ↓: Select Item	
Maximum length		20		Enter: Select	
Administrator Password				+/-: Change Opt.	
User Password				F1: General Help	
HDD Security Configuration:				F2: Previous Values	
HDD 0: WDC WD 1600BE				F3: Optimized Defaults	
				F4: Save & Exit	
				ESC: Exit	
Version 2.16.1242. Copyright (C) 2013, American Megatrends, Inc.					

Feature	Description
Administrator Password	Set administrator password
User Password	Set user password



If only the administrator's password is set, then only access to setup is limited. The password is only entered when entering setup.

If only the user's password is set, then the password is a power on password and must be entered to boot or enter setup. Within the setup menu the user has administrator rights.

Password length requirements are maximum 20 characters and minimum 3 characters.

9.2.5.1. Remember the password

It is highly recommended to keep a record of all passwords in a safe place. Forgotten passwords results in being locked out of the system.

If the system cannot be booted because the User Password or the Supervisor Password are not know, contact Kontron Support for further assistance.



HDD security passwords cannot be cleared using the above method.

9.2.6. Save & Exit Setup Menu

The exit setup menu provides functions for handling changes made to the UEFI BIOS settings and the exiting of the setup program.

Figure 58: BIOS Boot Setup Menu

BIOS SETUP UTILITY					
Main	Advanced	Power	Boot	Security	Save & Exit
Save Changes and Reset					
Discard Changes and Reset					
Save Options				→ ←: Select Screen	
Save Changes				↑ ↓: Select Item	
Discard Changes				Enter: Select	
Restore Defaults				+/-: Change Opt.	
				F1: General Help	
				F2: Previous Values	
				F3: Optimized Defaults	
				F4: Save & Exit	
				ESC: Exit	
Version 2.16.1242. Copyright (C) 2013, American Megatrends, Inc.					

Feature	Description
Save Changes and Exit	Exit system setup after saving the changes. Once you are finished making your selections, choose this option from the Exit menu to ensure the values you selected are saved to the CMOS RAM. The CMOS RAM is sustained by an onboard backup battery and stays on even when the PC is turned off. When you select this option, a confirmation window appears. Select [Yes] to save changes and exit.
Discard Changes and Exit	Exit system setup without saving any changes. Select this option only if you do not want to save the changes that you made to the Setup program. If you made changes to fields other than system date, system time, and password, the BIOS asks for a confirmation before exiting.
Save Changes	Save changes done so far to any of the setup values. This option allows you to save the selections you made. After selecting this option, a confirmation appears. Select [Yes] to save any changes.
Discard Changes	Discards changes done so far to any of the setup values. This option allows you to discard the selections you made and restore the previously saved values. After selecting this option, a confirmation appears. Select [Yes] to discard any changes and load the previously saved values.
Restore Defaults	Restore Default values for all the setup values. This option allows you to load optimal default values for each of the parameters on the Setup menus, which will provide the best performance settings for your system. The F9 key can be used for this operation.



About Kontron

Kontron, a global leader in embedded computing technology (ECT), offers a combined portfolio of secure hardware, middleware and services for Internet of Things (IoT) and Industry 4.0 applications. With its standard products and tailor-made solutions based on highly reliable state-of-the-art embedded technologies, Kontron provides secure and innovative applications for a variety of industries. As a result, customers benefit from accelerated time-to-market, reduced total cost of ownership, product longevity and the best fully integrated applications overall. Kontron is a listed company. Its shares are traded in the Prime Standard segment of the Frankfurt Stock Exchange and on other exchanges under the symbol "KBC". For more information, please visit: www.kontron.com

▼

PRODUCT CONTACT
POINT

KONTRON ASIA INC.

4F, No. 415, Ti-Ding Blvd.,
Sec. 2, Neihu District,
Taipei, Taiwan 114741
Tel.: + 886 2 2799 2789
Fax: + 886 2 2799 7399
SalesAsia@kontron.com