



## FlatClient PRO RPL

User Guide, Rev 1.0

Doc. ID 1074-8450

This page has been intentionally left blank

# FlatClient PRO RPL – User Guide

## Disclaimer

Kontron would like to point out that the information contained in this user guide may be subject to alteration, particularly as a result of the constant upgrading of Kontron products. This document does not entail any guarantee on the part of Kontron with respect to technical processes described in the user guide or any product characteristics set out in the user guide. Kontron assumes no responsibility or liability for the use of the described product(s), conveys no license or title under any patent, copyright or mask work rights to these products and makes no representations or warranties that these products are free from patent, copyright or mask work right infringement unless otherwise specified. Applications that are described in this user guide are for illustration purposes only. Kontron makes no representation or warranty that such application will be suitable for the specified use without further testing or modification. Kontron expressly informs the user that this user guide only contains a general description of processes and instructions which may not be applicable in every individual case. In cases of doubt, please contact Kontron.

This user guide is protected by copyright. All rights are reserved by Kontron. No part of this document may be reproduced, transmitted, transcribed, stored in a retrieval system, or translated into any language or computer language, in any form or by any means (electronic, mechanical, photocopying, recording, or otherwise), without the express written permission of Kontron. Kontron points out that the information contained in this user guide is constantly being updated in line with the technical alterations and improvements made by Kontron to the products and thus this user guide only reflects the technical status of the products by Kontron at the time of publishing.

Brand and product names are trademarks or registered trademarks of their respective owners.

©2026 by Kontron Europe GmbH

Kontron Europe GmbH  
Gutenbergstraße 2  
85737 Ismaning  
Germany  
[www.kontron.com](http://www.kontron.com)

## Intended Use

This device and associated software are not designed, manufactured or intended for use or resale for the operation of nuclear facilities, the navigation, control or communication systems for aircraft or other transportation, air traffic control, life support or life sustaining applications, weapons systems, or any other application in a hazardous environment, or requiring fail-safe performance, or in which the failure of products could lead directly to death, personal injury, or severe physical or environmental damage (collectively, “high risk applications”).

You understand and agree that your use of Kontron devices as a component in High Risk Applications is entirely at your risk. To minimize the risks associated with your products and applications, you should provide adequate design and operating safeguards. You are solely responsible for compliance with all legal, regulatory, safety, and security related requirements concerning your products. You are responsible to ensure that your systems (and any Kontron hardware or software components incorporated in your systems) meet all applicable requirements. Unless otherwise stated in the product documentation, the Kontron device is not provided with error-tolerance capabilities and cannot therefore be deemed as being engineered, manufactured or setup to be compliant for implementation or for resale as device in High Risk Applications. All application and safety related information in this document (including application descriptions, suggested safety measures, suggested Kontron products, and other materials) is provided for reference only.

---

**NOTICE**

You find the most recent version of the “General Safety Instructions” online in the download area of this product.

---

---

**NOTICE**

This product is not intended for use or suited for storage or operation in corrosive environments, in particular under exposure to sulfur and chlorine and their compounds. For information on how to harden electronics and mechanics against these stress conditions, contact Kontron Support.

---

## Revision History

Revision	Brief Description of Changes	Date of Issue	Author
1.0	Initial version	2026-Apr-21	CW

## Terms and Conditions

Kontron warrants products in accordance with defined regional warranty periods. For more information about warranty compliance and conformity, and the warranty period in your region, visit [www.kontron.com/terms-and-conditions](http://www.kontron.com/terms-and-conditions).

Kontron sells products worldwide and declares regional General Terms & Conditions of Sale, and Purchase Order Terms & Conditions. Visit [www.kontron.com/terms-and-conditions](http://www.kontron.com/terms-and-conditions).

For contact information, refer to the corporate offices contact information on the last page of this user guide or visit our website [CONTACT US](#).

## Customer Support

Find Kontron contacts by visiting [www.kontron.com/support-and-services](http://www.kontron.com/support-and-services).

## Customer Service

As a trusted technology innovator and global solutions provider, Kontron extends its embedded market strengths into a services portfolio allowing companies to break the barriers of traditional product lifecycles. Proven product expertise coupled with collaborative and highly-experienced support enables Kontron to provide exceptional peace of mind to build and maintain successful products.

For more details on Kontron's service offerings such as: enhanced repair services, extended warranty, Kontron training academy, and more visit [www.kontron.com/support-and-services](http://www.kontron.com/support-and-services).

## Customer Comments

If you have any difficulties using this user guide, discover an error, or just want to provide some feedback, contact [Kontron support](#). Detail any errors you find. We will correct the errors or problems as soon as possible and post the revised user guide on our website.

## Symbols

The following symbols may be used in this user guide



**DANGER** indicates a hazardous situation which, if not avoided, will result in death or serious injury.



**WARNING** indicates a hazardous situation which, if not avoided, could result in death or serious injury.



**NOTICE** indicates a property damage message.



**CAUTION** indicates a hazardous situation which, if not avoided, may result in minor or moderate injury

**ATTENTION** indique une situation dangereuse qui, si elle n'est pas évitée, peut entraîner des blessures mineures ou modérées.



### Electric Shock!

This symbol and title warn of hazards due to electrical shocks (> 60 V) when touching products or parts of products. Failure to observe the precautions indicated and/or prescribed by the law may endanger your life/health and/or result in damage to your material.



### ESD Sensitive Device!

This symbol and title inform that the electronic boards and their components are sensitive to static electricity. Care must therefore be taken during all handling operations and inspections of this product in order to ensure product integrity at all times.



### Caution: HOT Surface!

Do NOT touch! Allow to cool before servicing.

### Attention : Surface CHAUDE !

Ne pas toucher ! Laissez refroidir avant de procéder à l'entretien.



### Caution: Laser!

This symbol and title inform of the risk of exposure to laser beam and light emitting devices (LEDs) from an electrical device. Eye protection per manufacturer notice shall be reviewed before servicing.



### Caution High sound pressure!

This symbol and title inform of a risk of high sound pressure possible with headphones.

There is a risk of hearing damage. Do not listen at high volume levels for long periods of time.



**Security**

This symbol indicates general information and guidelines regarding the product's cyber security to ensure secure installation, operation, maintenance and disposal of the product within the user's end environment.

---



This symbol indicates general information about the product and the user guide.

---



This symbol precedes helpful hints and tips for daily use.

---

## For Your Safety

Your new Kontron product was developed and tested carefully to provide all features necessary to ensure its compliance with electrical safety requirements. It was also designed for a long fault-free life. However, the life expectancy of your product can be drastically reduced by improper treatment during unpacking and installation. Therefore, in the interest of your own safety and of the correct operation of your new Kontron product, you are requested to conform with the following guidelines.

### High Voltage Safety Instructions

As a precaution and in case of danger, the power connector must be easily accessible. The power connector is the product's main disconnect device.

#### ⚠ CAUTION

##### Warning

All operations on this product must be carried out by sufficiently skilled personnel only.

#### ⚠ CAUTION



##### Electric Shock!

Before installing a non hot-swappable Kontron product into a system always ensure that your mains power is switched off. This also applies to the installation of piggybacks. Serious electrical shock hazards can exist during all installation, repair, and maintenance operations on this product. Therefore, always unplug the power cable and any other cables which provide external voltages before performing any work on this product.

Earth ground connection to vehicle's chassis or a central grounding point shall remain connected. The earth ground cable shall be the last cable to be disconnected or the first cable to be connected when performing installation or removal procedures on this product.

### Special Handling and Unpacking Instruction

#### NOTICE



##### ESD Sensitive Device!

Electronic boards and their components are sensitive to static electricity. Therefore, care must be taken during all handling operations and inspections of this product, in order to ensure product integrity at all times.

#### ⚠ CAUTION

Handling and operation of the product is permitted only for trained personnel within a workplace that is access controlled. Follow the "General Safety Instructions" supplied with the product.

Do not handle this product out of the product's protective enclosure while the product is not used for operational purposes unless the product is otherwise protected.

Whenever possible, unpack or pack this product only at an EOS/ESD safe workplace. Where a safe workplace is not guaranteed, it is important for the user to be electrically discharged before touching the product with his/her hands or tools. This is most easily done by touching a metal part of your system housing.

It is particularly important to observe standard anti-static precautions when changing piggybacks, ROM devices, jumper settings etc. If the product contains batteries for RTC or memory backup, ensure that the product is not placed on conductive surfaces, including anti-static plastics or sponges. They can cause short circuits and damage the batteries or conductive circuits on the product.

## Lithium Battery Precautions

If your product is equipped with a lithium battery, take the following precautions when replacing the lithium battery.

### **⚠ CAUTION**

Risk of Explosion if the lithium Battery is replaced by an incorrect Type. Dispose of used lithium batteries according to the instructions.

Risque d'explosion si la pile au lithium est remplacée par une pile de type incorrect.  
Éliminez les piles au lithium usagées conformément aux instructions.

## General Instructions on Usage

In order to maintain Kontron's product warranty, this product must not be altered or modified in any way. Changes or modifications to the product, that are not explicitly approved by Kontron and described in this user guide or received from Kontron Support as a special handling instruction, will void your warranty.

This product should only be installed in or connected to systems that fulfill all necessary technical and specific environmental requirements. This also applies to the operational temperature range of the specific board version that must not be exceeded. If batteries are present, their temperature restrictions must be taken into account.

In performing all necessary installation and application operations, only follow the instructions supplied by the present user guide.

Keep all the original packaging material for future storage or warranty shipments. If it is necessary to store or ship the product then re-pack it in the same manner as it was delivered.

Special care is necessary when handling or unpacking the product. See Special Handling and Unpacking Instruction.

## Quality and Environmental Management

Kontron aims to deliver reliable high-end products designed and built for quality, and aims to comply with environmental laws, regulations, and other environmentally oriented requirements. For more information regarding Kontron's quality and environmental responsibilities, visit [Quality | Kontron](#) and [Material Compliance | Kontron](#).

# Table of Contents

Revision History.....	5
Symbols .....	6
For Your Safety.....	8
High Voltage Safety Instructions .....	8
Special Handling and Unpacking Instruction .....	8
Lithium Battery Precautions .....	9
General Instructions on Usage .....	9
Quality and Environmental Management .....	9
Table of Contents .....	10
List of Tables.....	12
List of Figures .....	13
1/ Introduction.....	14
2/ General Safety Instructions .....	15
2.1. Additional Safety Instructions for DC Power Supply Circuits .....	16
2.2. Instructions générales de sécurité .....	16
2.3. Electrostatic Discharge (ESD).....	17
2.4. Grounding Methods .....	18
2.5. Instructions for Lithium Battery .....	18
2.6. Thermal Conditions .....	19
3/ Shipment and Unpacking .....	20
3.1. Packaging.....	20
3.2. Unpacking.....	20
3.3. Scope of Delivery.....	20
3.4. Accessories .....	21
3.5. Type Label and Product Identification.....	22
4/ Product Features .....	23
4.1. Front Features .....	23
4.1.1. Touch Screen Display .....	23
4.2. Rear Panel Features.....	25
4.3. Interface Panel Features .....	27
4.3.1. Power IN Connector (X101) .....	27
4.3.2. Power Button.....	27
4.3.3. Functional Earth Bolt .....	27
4.3.4. Power LED and State LED.....	27
4.3.5. Ethernet 2.5 GbE Ports (X102, X103) .....	28
4.3.6. USB 3.2 Gen 2 ports (X104, X105, X106, X107) .....	28
4.3.7. Display Ports (X108, X109).....	28
4.3.8. Breakout Panels (X110, X111) (option).....	29
4.4. Additional Features .....	30
4.4.1. Automotive Battery (option) .....	30
4.4.2. RFID-Reader (option) .....	30
4.4.3. Additional Features (On Request Only) .....	30
5/ Order Information .....	32
6/ Product Specification .....	33
6.1. Block Diagram.....	33
6.2. Technical Specifications.....	34
6.3. Software Specification.....	36
6.4. Environmental Specification.....	36
6.5. Power Specification .....	37
6.5.1. Power Supply Protection Requirements.....	38
6.5.2. Functional Earth Bolt .....	38
6.6. Compliance .....	39
7/ Thermal and Power Management.....	41
7.1. Passive Cooling .....	41
7.2. Heatsink (optional) .....	41

7.3. Mount Orientation .....	43
7.4. Minimum Clearance .....	43
7.5. Maximum Processor Power and Temperature .....	43
7.6. Power Consumption and Thermal Monitoring.....	44
7.7. Derating TDP Curves.....	44
7.8. Configuring the Processor TDP .....	44
7.9. Third Party Components.....	44
8/ Mechanical Specification.....	45
8.1. 10.1" Panel Mount .....	46
8.2. 10.1" VESA.....	47
8.3. 12.1" Panel Mount .....	48
8.4. 12.1" VESA.....	49
8.5. 15.6" Panel Mount .....	50
8.6. 15.6 VESA.....	51
8.7. 18.5" Panel Mount .....	52
8.8. 18.5" VESA.....	53
8.9. 21.5" Panel Mount .....	54
8.10. 21.5" VESA.....	55
8.11. 23.8" Panel Mount .....	56
8.12. 23.8" VESA.....	57
9/ Installation.....	58
9.1. Mounting Instructions - Panel Mount .....	58
9.2. Mounting Instructions - VESA.....	60
10/ Starting Up.....	61
10.1. Connecting to the AC/DC Power Supply.....	62
10.2. Connecting to an External 24 VDC Power Supply.....	62
10.2.1. Wiring the Mating Power Connector .....	62
10.3. Switching On/Off .....	63
11/ Connector Pin Assignments.....	64
11.1. Power IN Connector (X101).....	64
11.2. Ethernet 2.5 GbE Ports (X102, X103).....	64
11.3. USB 3.2 Gen 2 Connectors (X104, X105, X106, X107) .....	65
11.4. Display Port Connectors (X108, X109).....	66
11.5. Breakout Panel (option) .....	67
11.5.1. Serial Port (COM) Connector (X110, X111).....	67
11.5.2. Wi-Fi/BT® Antenna (X110, X111).....	67
11.6. Internal Headers.....	68
11.6.1. Automotive Battery Header .....	68
12/ BIOS .....	69
12.1. Starting the uEFI BIOS.....	69
12.2. BIOS Update .....	70
12.3. Setup Menus .....	70
12.4. Main Setup Menu .....	71
12.5. Advanced Setup Menu .....	73
12.6. ChipSet Setup Menu.....	82
12.7. Security Setup Menu .....	89
12.8. Boot Setup Menu .....	91
12.9. Save and Exit Setup Menu .....	92
13/ Maintenance and Prevention.....	93
13.1. Cleaning the Front .....	93
13.2. Cleaning the Rear Panel .....	94
13.3. Replacing the Internal RTC Lithium Battery .....	94
13.4. Exchanging the Automotive RTC Lithium Battery (option) .....	94
13.5. Exchanging the 2.5" SSD (option).....	96
14/ Technical Support.....	97
14.1. Returning Defective Merchandise.....	97
15/ Storage and Transportation .....	98

15.1. Storage .....	98
15.2. Transportation.....	98
16/ Warranty .....	99
17/ Disposal .....	100
17.1. Disposal .....	100
17.2. WEEE Compliance.....	100
17.3. Data Sanitization .....	100
17.4. Statement of Memory Volatility.....	102
18/ Cyber Security .....	104
18.1. Security Defense Strategy .....	104
Appendix: List of Acronyms.....	105

## List of Tables

Table 1: Scope of Delivery .....	20
Table 2: List of Accessories.....	21
Table 3: Glove Type Performance .....	24
Table 4: STAT LED and PWR LED Description .....	27
Table 5: Wi-Fi/BT® Features .....	29
Table 6: Order Number Information .....	32
Table 7: Display Specification .....	34
Table 8: Hardware Specification .....	35
Table 9: Software Specification.....	36
Table 10: Environmental Specification.....	36
Table 11: Electrical Specification 24 VDC .....	37
Table 12: Typical Power Consumption @ Typical Load and 24 VDC .....	37
Table 13: Compliance CE Mark.....	39
Table 14: Compliance CE RED Mark .....	39
Table 15: Compliance International .....	40
Table 16: Heatsink Dimensions .....	42
Table 17: Processor TDP and Maximum Temperatures .....	43
Table 18: Mechanical Dimensions Overview .....	45
Table 19: Power IN Connector Pin Assignment.....	64
Table 20: Ethernet 2.5 GbE Port Pin Assignment (X102, X103).....	64
Table 21: USB 3.2 Gen 2 Type A Pin Assignment (X104, X105, X106, X107) .....	65
Table 22: Display Port Pin Assignment (X108, X109) .....	66
Table 23: Serial Port (RS232) Pin Assignment .....	67
Table 24: Wi-Fi/BT® Antenna Pin Assignment .....	67
Table 25: Automotive Battery Header Pin Assignment.....	68
Table 26: Navigation Hot Keys .....	69
Table 27: Advanced Setup Menu Sub-screens .....	74
Table 28: Chipset Setup Menu Sub-screens.....	82
Table 29: Security Setup Menu Sub-screen .....	89
Table 30: Boot Setup Menu Sub-screens .....	91
Table 31: Save and Exit Setup Menu Sub-screens.....	92
Table 32: FlatClient PRO RPL Statement of Memory Volatility .....	102

## List of Figures

Figure 1: FlatClient PRO RPL.....	14
Figure 2: Type Label Example.....	22
Figure 3: Front (VESA and panel mount).....	23
Figure 4: Rear Panel (panel mount).....	25
Figure 5: Rear Panel (VESA).....	26
Figure 6: Interface Panel.....	27
Figure 7: Connectors and Antenna Type.....	29
Figure 8: FlatClient PRO RPL Block Diagram.....	33
Figure 9: Performance vs Temperatures (35°C /95°F), 50°C /122°F).....	41
Figure 10: Rear Panel (panel mount and VESA) with Heatsink.....	42
Figure 11: Mounting Set with Clamping Brackets and Screws.....	59
Figure 12: Clamping Bracket with Screw.....	59
Figure 13: Clamping Bracket Insertion.....	59
Figure 14: Fastening the Clamping Bracket.....	59
Figure 15: Clamping Bracket Positions.....	59
Figure 16: Mating Power Connector.....	62
Figure 17: Main Setup Menu Example.....	71
Figure 18: Advanced Setup Menu Example.....	73
Figure 19: Chipset Setup Menu.....	82
Figure 20: Security Setup Menu Example.....	89
Figure 21: Boot Setup Menu Example.....	91
Figure 22: Save and Exit Setup Menu Example.....	92
Figure 23: Automotive Battery Service Flap.....	95
Figure 24: 2.5" SSD Service Flap.....	96

# 1/Introduction

This user guide describes the FlatClient PRO RPL, part of the FlatClient industrial HMI series of monitors known as FlatClient or product within this user guide. This user guide focuses on describing the product's special features and how to assemble, install, operate, maintain and dispose of the product properly. New users are recommended to study the instructions within this user guide before switching on the product.

The FlatClient industrial HMI series, available as ECO and PRO variants, offers high mechanical flexibility with respect to design. The FlatClient can be used both standalone as a VESA solution (75 mm or 100 mm) or can be directly integrated into machines or consoles with a panel mount solution with PCAP touch and protection glass. The FlatClient supports numerous display sizes from 10.1" up to 23.8", with Full-HD resolution for brilliant visualization.

The FlatClient features an easy-clean, anti-glare and scratch-proof IP65 protected front glass. The FlatClient is service-friendly and designed for a long life cycle thanks to carefully selected components from renowned manufacturers.

**Figure 1: FlatClient PRO RPL**



To ensure you have the latest version of this user guide, visit the [FlatClient PRO RPL Website](#).

---

## 2/General Safety Instructions

Please read this passage carefully and take careful note of the instructions, which have been compiled for your safety and to ensure to apply in accordance with intended regulations. If the following general safety instructions are not observed, it could lead to injuries to the operator and/or damage of the product; in cases of non-observance of the instructions Kontron Europe is exempt from accident liability, this also applies during the warranty period.

The product has been built and tested according to the basic safety requirements for low voltage (LVD) applications and has left the manufacturer in safety-related, flawless condition. To maintain this condition and to also ensure safe operation, the operator must not only observe the correct operating conditions for the product but also the following general safety instructions:

- The product must be used as specified in the product documentation, in which the instructions for safety for the product and for the operator are described. These contain guidelines for setting up, installation and assembly, maintenance, transport or storage.
- The on-site electrical installation must meet the requirements of the country's specific local regulations.
- If a power cable comes with the product, only this cable should be used. Do not use an extension cable to connect the product.
- To guarantee that sufficient air circulation is available to cool the product, please ensure that the ventilation openings are not covered or blocked. If a filter mat is provided, this should be cleaned regularly. Do not place the product close to heat sources or damp places. Make sure the product is well ventilated.
- Only connect the product to an external power supply providing the voltage type (AC or DC) and the input power (max. current) specified on the Kontron Product Label and meeting the requirements of the Limited Power Source (LPS) and Power Source (PS2) of UL/IEC 62368-1 .
- Only products or parts that meet the requirements for Power Source (PS1) of UL/IEC 62368-1 may be connected to the product's available interfaces (I/O).
- Before opening the product, make sure that the product is disconnected from the mains.
- Switching off the product by its power button does not disconnect it from the mains. Complete disconnection is only possible if the power cable is removed from the wall plug or from the product. Ensure that there is free and easy access to enable disconnection.
- The product may only be opened for the insertion or removal of add-on cards (depending on the configuration of the product). This may only be carried out by qualified operators.
- If extensions are being carried out, the following must be observed:
  - all effective legal regulations and all technical data are adhered to
  - the power consumption of any add-on card does not exceed the specified limitations
  - the current consumption of the product does not exceed the value stated on the product label
- Only original accessories that have been approved by Kontron Europe can be used.
- Please note: safe operation is no longer possible when any of the following applies:
  - the product has visible damages or
  - the product is no longer functioning
 In this case the product must be switched off and it must be ensured that the product can no longer be operated.
- Handling and operation of the product is permitted only for trained personnel within a work place that is access controlled.
- CAUTION: Risk of explosion if the lithium battery is replaced incorrectly (short-circuited, reverse-poled, wrong lithium battery type). Dispose of used lithium batteries according to the manufacturer's instructions.
- This product is not suitable for use in locations where children are likely to be present

## 2.1. Additional Safety Instructions for DC Power Supply Circuits

- › To guarantee safe operation, please observe that:
  - › the external DC power supply must meet the criteria for LPS and PS2 (UL/IEC 62368-1)
  - › no cables or parts without insulation in electrical circuits with dangerous voltage or power should be touched directly or indirectly
  - › a reliable functional earth connection is provided
  - › a suitable, easily accessible disconnecting device is used in the application (e.g. overcurrent protective device), if the product itself is not disconnect able
  - › a disconnect device, if provided in or as part of the product, shall disconnect both poles simultaneously
  - › interconnecting power circuits of different products cause no electrical hazards
- › A sufficient dimensioning of the power cable wires must be selected – according to the maximum electrical specifications on the product label – as stipulated by EN62368-1 or VDE0100 or EN60204 or UL61010-1 regulations.

For the General Safety Instruction in German or French, visit Kontron's product web page> Downloads> Manuals> General Safety Instructions.

## 2.2. Instructions générales de sécurité

Veillez lire attentivement ce passage et prendre bonne note des instructions, qui ont été compilées pour votre sécurité et pour assurer une application conforme aux réglementations prévues. Le non-respect des consignes de sécurité générales suivantes peut entraîner des blessures pour l'utilisateur et/ou des dommages pour le produit. En cas de non-respect des consignes, Kontron Europe est exonéré de la responsabilité en cas d'accident, ceci s'applique également pendant la période de garantie.

Le produit a été construit et testé conformément aux exigences de sécurité de base pour les applications basse tension (DBT) et a quitté le fabricant dans un état impeccable en matière de sécurité. Pour maintenir cet état et pour garantir également un fonctionnement sûr, l'opérateur doit non seulement respecter les conditions d'utilisation correctes du produit, mais aussi les consignes de sécurité générales suivantes :

- › Le produit doit être utilisé conformément à la documentation du produit, dans laquelle sont décrites les instructions de sécurité pour le produit et pour l'opérateur. Celles-ci contiennent des directives pour la mise en place, l'installation et le montage, la maintenance, le transport ou le stockage.
- › L'installation électrique sur place doit répondre aux exigences des réglementations locales spécifiques du pays.
- › Si un câble d'alimentation est fourni avec le produit, seul ce câble doit être utilisé. N'utilisez pas de rallonge pour connecter le produit.
- › Afin de garantir une circulation d'air suffisante pour refroidir le produit, veuillez vous assurer que les ouvertures de ventilation ne sont pas couvertes ou obstruées. Si un élément filtrant est fourni, celui-ci doit être nettoyé régulièrement. Ne placez pas le produit à proximité de sources de chaleur ou d'endroits humides. Veillez à ce que le produit soit bien ventilé.
- › Ne connectez le produit qu'à une alimentation externe fournissant le type de tension (AC ou DC) et la puissance d'entrée (courant max.) spécifiés sur le Label Produit Kontron et répondant aux exigences de la source d'alimentation limitée (LPS) et de la source d'alimentation (PS2) de la norme UL/IEC 62368-1 .
- › Seuls les produits ou les pièces qui répondent aux exigences de la source d'alimentation (PS1) de la norme UL/IEC 62368-1 peuvent être connectés aux interfaces (E/S) disponibles du produit.
- › Avant d'ouvrir le produit, assurez-vous qu'il est bien débranché du secteur.
- › Le fait d'éteindre le produit par son bouton de mise en marche ne le déconnecte pas du secteur. Une déconnexion complète n'est possible que si le câble d'alimentation est retiré de la prise murale ou du produit. Veillez à ce que l'accès soit libre et facile pour permettre la déconnexion.
- › Le produit ne peut être ouvert que pour l'insertion ou le retrait de cartes supplémentaires (selon la configuration du produit). Cette opération ne peut être effectuée que par des opérateurs qualifiés.

- Si des extensions sont effectuées, les points suivants doivent être respectés :
  - toutes les réglementations légales en vigueur et toutes les données techniques sont respectées
  - la consommation électrique d'une carte supplémentaire ne dépasse pas les limites spécifiées
  - la consommation actuelle du produit ne dépasse pas la valeur indiquée sur l'étiquette du produit.
- Seuls les accessoires d'origine approuvés par Kontron Europe peuvent être utilisés.
- Veuillez noter que la sécurité des opérations n'est plus possible lorsque l'une des conditions suivantes s'applique.
  - le produit présente des dommages visibles ou
  - le produit ne fonctionne plus. Dans ce cas, le produit doit être éteint et il faut s'assurer que le produit ne puisse plus être utilisé.
- La manipulation et le fonctionnement du produit ne sont autorisés que pour le personnel formé dans un lieu de travail dont l'accès est contrôlé.
- ATTENTION: Risque d'explosion en cas de remplacement incorrect de la pile au lithium (court-circuit, inversion de polarité, mauvais type de pile au lithium). Éliminez les piles au lithium usagées conformément aux instructions du fabricant.
- Ce produit n'est pas adapté à une utilisation dans des endroits où des enfants sont susceptibles d'être présents
- Instructions de sécurité supplémentaires pour les circuits d'alimentation en courant continu
- Pour garantir un fonctionnement sûr, veuillez observer ce qui suit:
  - l'alimentation électrique externe en courant continu doit répondre aux critères des LPS et PS2 (UL/IEC 62368-1)
  - aucun câble ou pièce non isolée dans les circuits électriques ayant une tension ou une puissance dangereuse ne doit être touché directement ou indirectement
  - une connexion à la terre fonctionnelle fiable est fournie
  - un dispositif de déconnexion approprié et facilement accessible est utilisé dans l'application (par exemple, un dispositif de protection contre les surintensités), si le produit lui-même n'est pas en mesure d'être déconnecté.
  - un dispositif de déconnexion, s'il est prévu dans le produit ou s'il en fait partie, doit déconnecter les deux pôles simultanément
  - l'interconnexion des circuits électriques de différents produits ne présente aucun risque électrique
- Un dimensionnement suffisant des fils du câble d'alimentation doit être choisi - en fonction des spécifications électriques maximales figurant sur l'étiquette du produit - comme stipulé par les réglementations EN62368-1 ou VDE0100 ou EN60204 ou UL61010-1.

### 2.3. Electrostatic Discharge (ESD)

A sudden discharge of electrostatic electricity can destroy static-sensitive devices or micro-circuitry. Therefore, proper packaging and grounding techniques are necessary precautions to prevent damage.

Always take the following precautions:



#### ESD Sensitive Device!

Keep electrostatic sensitive parts in their containers until they arrive at the ESD-safe workplace. Always be properly grounded when touching a sensitive board, component, or assembly.

For more Information, see the Special Handling and Unpacking Instruction within this user guide and Chapter 2.4: Grounding Methods.

## 2.4. Grounding Methods

The following measures help to avoid electrostatic damages to the device:

- › Cover workstations with approved antistatic material. Always wear a wrist strap connected to the workplace, as well as properly grounded tools and equipment.
- › Use antistatic mats, heel straps, or air ionizers for more protection.
- › Always handle electrostatically sensitive components by their edge or by their casing.
- › Avoid contact with pins, leads, or circuitry.
- › Switch off power and input signals before inserting and removing connectors or connecting test equipment.
- › Keep the work area free of non-conductive materials such as ordinary plastic assembly aids and styrofoam.
- › Use field service tools such as cutters, screwdrivers, and vacuum cleaners that are conductive.
- › Always place drives and boards with the PCB-assembly-side down on the foam.

## 2.5. Instructions for Lithium Battery

The product is equipped with an RTC lithium battery, The RTC lithium battery may over time need to be replaced. There is a risk of explosion if the RTC lithium battery is replaced incorrectly (short-circuited, reverse-poled, wrong lithium battery type).

Replace the RTC lithium battery, only with the same type of RTC lithium battery or with a Kontron recommended RTC lithium battery type, see Table 2: List of Accessories.

For instructions on how to replace the RTC Lithium battery, see Chapter 13/: Maintenance and Prevention. After removing the RTC lithium battery, dispose of the RTC lithium battery according to the regulations within your region.

### ⚠ CAUTION

#### **Danger of Explosion if the lithium battery is incorrectly placed!**

- › Replace only with the same or equivalent type recommended by the manufacturer
- › Dispose of used batteries according to the manufacturer's instructions

#### **ATTENTION- Risque d'explosion avec l'échange inadéquat de la batterie!**

- › Remplacement seulement par le même ou un type équivalent recommandé par le producteur
- › L'évacuation des batteries usagées conformément à des indications du fabricant

#### **VORSICHT- Explosionsgefahr bei unsachgemäßem Austausch der Batterie!**

- › Ersatz nur durch denselben oder einen vom Hersteller empfohlenen gleichwertigen Typ
- › Entsorgung gebrauchter Batterien nach Angaben des Herstellers



An empty RTC lithium battery BIOS does not affect the BIOS settings. However, the system time and date are affected when the RTC lithium battery is empty and must be reconfigured after replacing the battery.



Do not dispose of lithium batteries in general trash collection. Dispose of the lithium battery according to the local regulations dealing with the disposal of these special materials, (e.g. to the collecting points for disposal of batteries).

## 2.6. Thermal Conditions

The product may be passively cooled using a heatsink. There is a risk of burns or injury when touching the heatsink.

---



### Hot Surface

Heatsinks can get very hot. To avoid burns and personal injury when handling the heatsink:

- › Do not touch while in operation
- › Allow to cool before handling
- › Wear protective gloves

### Surface chaude

Le dissipateur thermique peut devenir très chaud. Pour éviter les brûlures et les blessures lors de la manipulation du dissipateur thermique :

- › Ne pas toucher pendant le fonctionnement
- › Laisser refroidir avant la manipulation
- › Portez des gants de protection

### Heiße Oberfläche

Der Kühlkörper kann sehr heiß werden. Um Verbrennungen und Verletzungen beim Umgang mit dem Kühlkörper zu vermeiden:

- › Während des Betriebs nicht berühren
  - › Vor der Handhabung abkühlen lassen
  - › Schutzhandschuhe tragen
-

## 3/ Shipment and Unpacking

### 3.1. Packaging

The FlatClient PRO RPL is packaged together with all parts, in a product specific cardboard package designed to provide adequate protection and absorb shock.

### 3.2. Unpacking

To unpack the FlatClient perform the following:



1. Remove packaging.
2. Do not discard the original packaging. Keep the original packaging for future transportation or storage.
3. Check the delivery for completeness by comparing the delivery with the original order.
4. Keep the associated paperwork. It contains important information for handling the product.
5. Check the product for visible shipping damage.

If you notice shipping damage or inconsistencies between the contents and the original order, contact your dealer.

### 3.3. Scope of Delivery







This scope of delivery describes the parts included in your delivery. Check that the delivery is complete and contains the items listed. If damaged or missing items are discovered, contact your dealer.

**Table 1: Scope of Delivery**

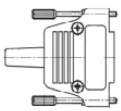
Part	Quantity	Part Number	Part Description
	1	Refer to: Chapter 5/: Order Information	FlatClient PRO RPL
		EM21-100168-01 (10.1") EM21-100065-01 (12.1") EM21-100066-01 (15.6") EM21-100068-01 (18.5"/23.8") EM21-100069-01 (21.5")	Mounting set for panel mount variant. Each set contains the correct number of clamps & M4x12 screws.
	1	0-0062-3268	3-pin Phoenix power connector (PSC 1.5/ 3-F)

### 3.4. Accessories

**Table 2: List of Accessories**

Product	Order Number	Description
	EE04-100001-01	Phoenix 3-pin power subcon in D-sub 9 connector
	ER40-100012-01	External Power Supply 24 VDC, 90 W with Phoenix connector (Prerequisite for products with Intel® Core™ i5 & i7 processors)
	840-0059	EU-power cord 1.8 m
	PR22-100004-01	Adapter cable HDMI – Display Port 1.2, 20 cm, 4K aktiv, Delock: 62607
	PR22-100005-01	Adapter HDMI – Display Port 1.2, 4K aktiv, Delock: 65573
Wi-Fi/BT® Antenna 	Manufacturer: SparkLan  Article Number: R3410A10050	Product Name: AD-501AX Connector: RP-SMA (male) IEEE Standards: 802.11ac/a/b/g/n Antenna Gain: 5 dBi Impedance: 50 ohms Frequency Range: 2.4 GHz/5 GHz/6 GHz Peak Gain: Peak 3.7 dBi/5 dBi/5 dBi L x W x T: 162 x 22 x 6.8 mm Articulated hinge: 0° to 90°

### 3.5. Type Label and Product Identification

The type label contains specific product identification information and FlatClient PRO RPL technical information.

**Figure 2: Type Label Example**

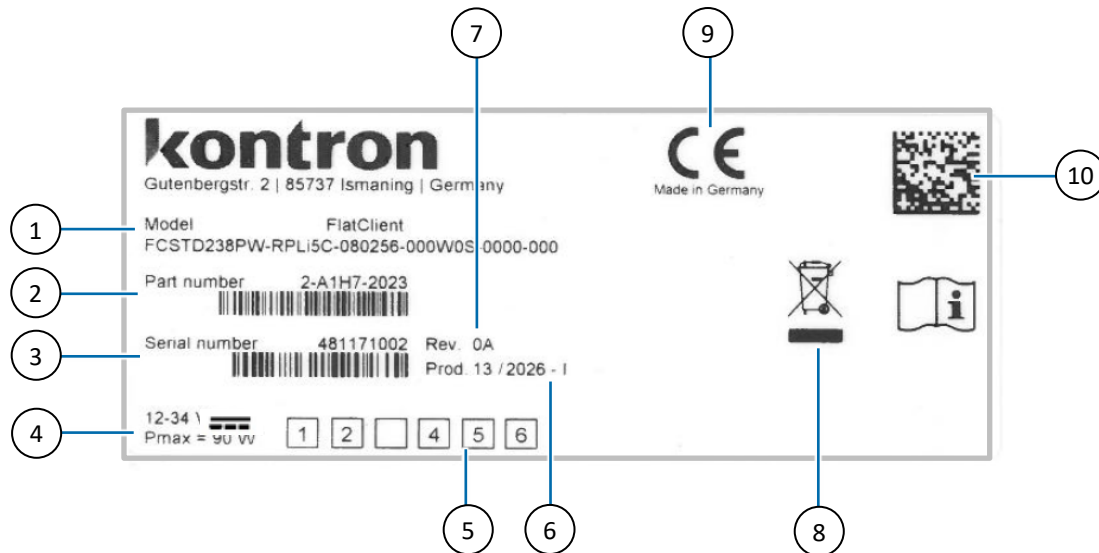

- |                               |                         |
|-------------------------------|-------------------------|
| 1. Product family             | 6. Production date      |
| 2. Part Number                | 7. Revision             |
| 3. Serial Number and bar code | 8. Disposal Information |
| 4. Electrical specification   | 9. Compliance           |
| 5. For Internal use [1 to 6]  | 10. QR-Code             |

## 4/Product Features

Before implementing the FlatClient PRO RPL in a system, Kontron recommends new users to take a few minutes to learn about the product's various features.

### 4.1. Front Features

The front is identical for panel mount and VESA variants. The front consists of a robust metal housing and tempered 2.8 mm front glass. The front's anti-glare and anti-fingerprint PCAP multi-touch provides excellent readability and operability.

**Figure 3: Front (VESA and panel mount)**



1. Bezel
2. Touch screen display
3. RFID-Reader position (option for display size 23.8")

#### 4.1.1. Touch Screen Display

The touch screen display uses projected multi-touch (PCAP) technology and is located behind the tempered front glass.

The glass surface of the touch area is practically wear-free and features:

- › Impact-protection
- › Scratch-resistance
- › Liquid resistant (Most liquids e.g. Petrol, Alcohol, Cleaning liquid)

The standard calibration of the touch screen includes the following functions:

- › 10 finger touch
- › Glove operation
  - › With assembly gloves and two layers of latex gloves, see Table 3: Glove Type Performance.
- › Palm detection and rejection
  - › Evaluates the touch surface, if the touch surface is bigger than a normal touch finger; the touch is recognized as a palm and not reported.
- › Water detection
  - › Detecting liquids (water condition) a ghost touch will be protected by reducing the sensitivity and allowing only two finger touch.
- › Immediate response time (Touch controller response time < 25 ms)

When touching the screen with gloves users must consider the glove type, material and thickness. Kontron recommends users to first perform an application test with the gloves to be used. The following table provides typical glove performance information.

**Table 3: Glove Type Performance**

Glove Type	Material	Thickness
Disposable and Hygienic gloves	Latex Nitril Vinyl/PVC	Single layer: 0.5 mm Dual layer: 0.2 mm each
Assembly gloves	Cotton	1.5 mm
Work gloves	Leather Polyester with Nitril coating	Up to 2 mm

Special customer requirements can be handled on request, such as:

- Sensitivity (e.g. special working gloves)
- Implement touch detection filters
- Attention to special liquids

## 4.2. Rear Panel Features

The FlatClient panel mount and VESA variants have different rear panels with different mounting fixtures. The panel mount variant has an optional service flap for display sizes (18.5" , 21.5" and 23.8") providing internal access for features.

The rear panel is sealed with a protection label. Opening the rear panel invalidates the warranty and may cause damage to internal components.

**Figure 4: Rear Panel (panel mount)**

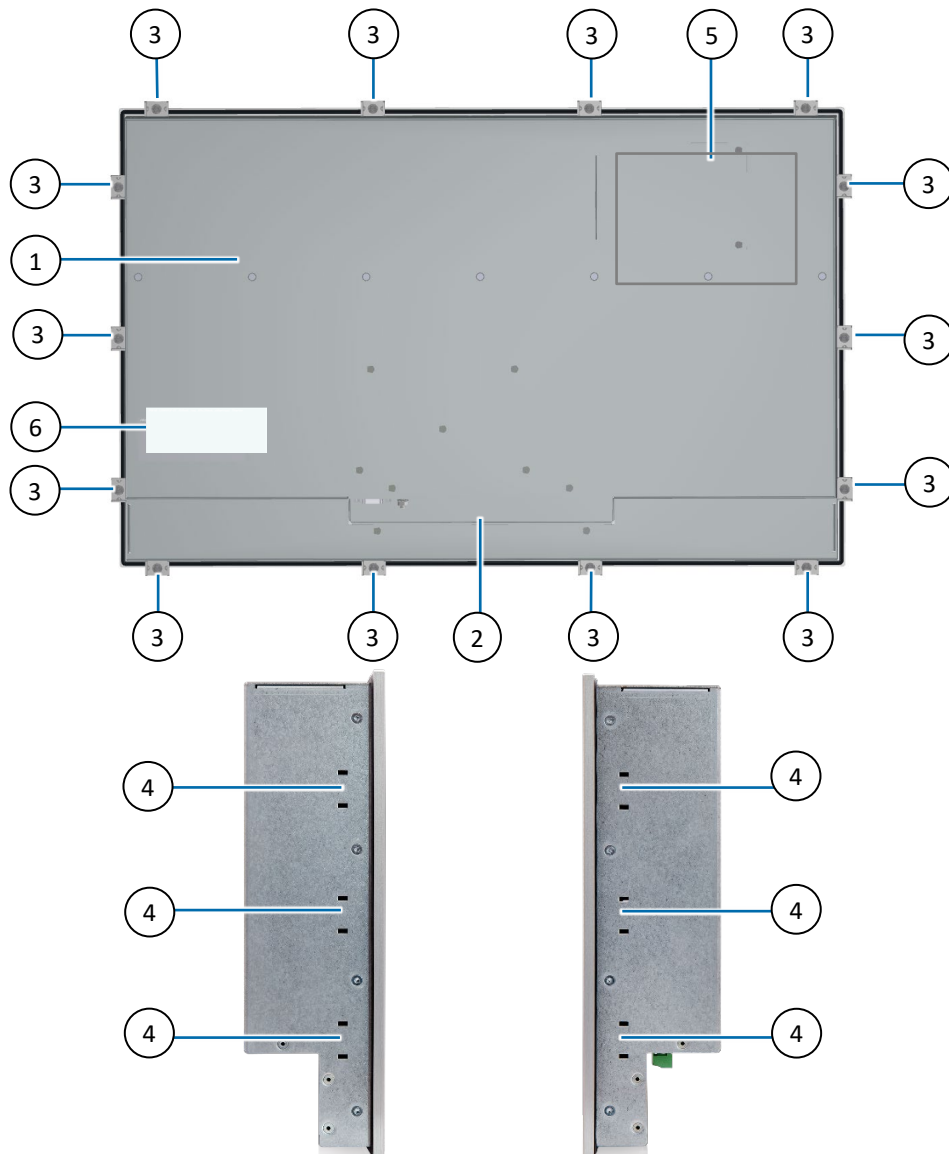

- |                      |                                 |
|----------------------|---------------------------------|
| 1. Rear panel        | 4. Opening for clamping bracket |
| 2. Interface panel   | 5. Service flap (option)        |
| 3. Clamping brackets | 6. Type label position          |



The number of clamping brackets depends on the size of the display. For more information, see Table 7: Display Specification.

Figure 5: Rear Panel (VESA)

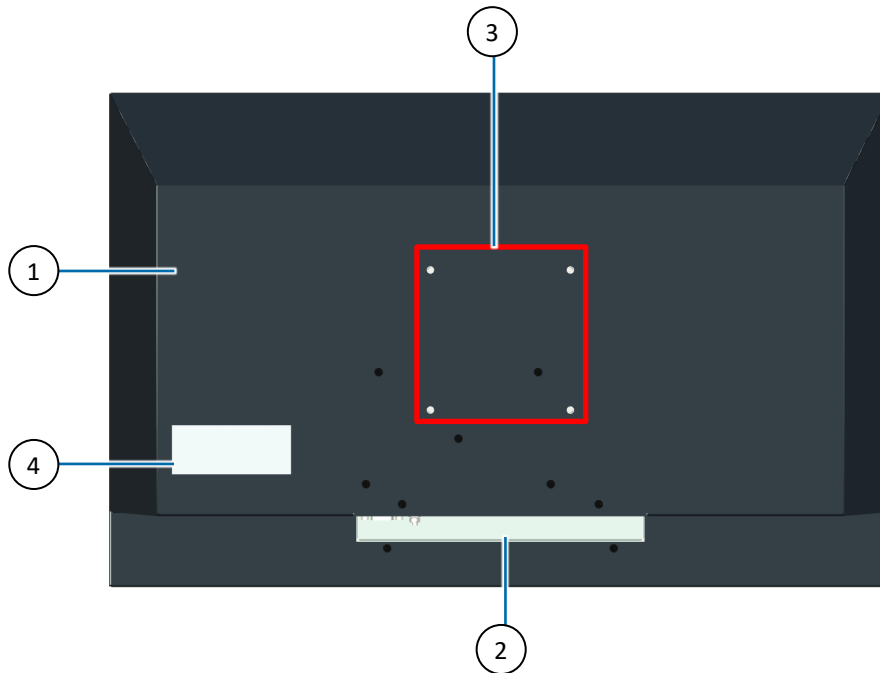

- |   |                 |   |  |
|---|-----------------|---|--|
| 1 | Rear Panel      | 3 | VESA mount openings<br>(75 mm or 100 mm) |
| 2 | Interface panel | 4 | Type Label position                      |



The VESA (75 mm or 100 mm) mount options are for:

- VESA 75 mm for display size 10.1" and 12.1"
- VESA 100 mm for display sizes 15.6", 18.6", 21.5" and 23.8"

### **NOTICE**

#### **Protection Label**

The product is factory configured to meet customer requirements and then sealed with a protection label. Opening the product's rear panel invalidates the warranty and may cause damage to internal components.

## 4.3. Interface Panel Features

Figure 6: Interface Panel

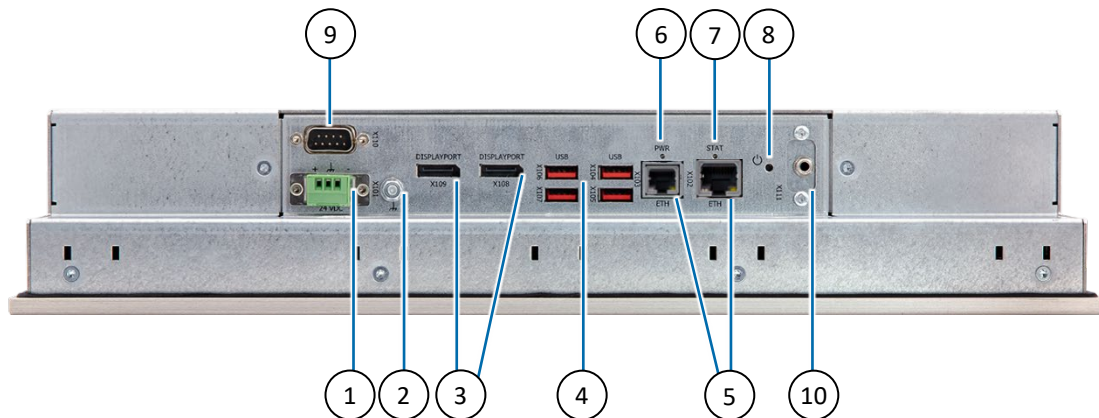

- |   |                                     |    |                            |
|---|-------------------------------------|----|----------------------------|
| 1 | Power IN (X101)                     | 6  | Power LED                  |
| 2 | Functional earth bolt               | 7  | State LED                  |
| 3 | 2x Display Port (DP++) (X108, X109) | 8  | Power button               |
| 4 | 4x USB 3.2 Gen 2 (X104-X107)        | 9  | Breakout (X110) for option |
| 5 | 2x 2.5 GbE Ethernet (X102, X103)    | 10 | Breakout (X111) for option |

### 4.3.1. Power IN Connector (X101)

The 3-pin Power IN connector (PSC 1.5/ 3-M) connects to an appropriate DC power supply using the mating power connector (PSC 1.5/ 3-F) included in the delivery. To wire the mating power connector, see Chapter 10.2.1: Wiring the Mating Power Connector. The FlatClient automatically switches on when the Power IN connector is connected to power or after a power-fail when power is recovered.

For the pin assignment of the Power IN connector, see Chapter 11.1: Power IN Connector (X101).

### 4.3.2. Power Button

The power button, when pressed shortly, switches on or switches off the product. Pressing the power button for more than 4 seconds triggers a hard shutdown.

### 4.3.3. Functional Earth Bolt

The functional earth bolt connects to the chassis ground.

### 4.3.4. Power LED and State LED

The STAT LED indicates the product's power status and the PWR LED indicates the product's power-good status.

Table 4: STAT LED and PWR LED Description

STAT LED (green)	PWR LED (yellow)	Description
On	On	Power on (fully operational)
Flashing	On	Suspend to RAM
Off	On	Suspend to disk or Soft off
Off	Off	Power off

### 4.3.5. Ethernet 2.5 GbE Ports (X102, X103)

The Ethernet ports (X102 and X103) each support one channel of 10/100/1000/2500 Mbit Ethernet.



To achieve the specified performance, Category 5 twisted pair cables must be used with 10/100 MByte and Category 5E, 6 or 6E with 1 GbE/2.5 GbE Ethernet networks.

---

For the pin assignment of the Ethernet ports and information regarding the Ethernet status LEDs, see Chapter 11.2: Ethernet 2.5 GbE Ports (X102, X103).

### 4.3.6. USB 3.2 Gen 2 ports (X104, X105, X106, X107)

The four USB ports (X104, X105, X106 and X107) support USB 3.2 Gen 2 compatible device using a USB Type A connector.



The four USB 3.2 Gen 2 ports are backwards compatible with earlier USB 3.0 versions and USB 2.0.

---

For the pin assignment of the USB 3.2 Gen 2 ports, see Chapter 11.3: USB 3.2 Gen 2 Connectors (X104, X105, X106, X107).

### 4.3.7. Display Ports (X108, X109)

The two Display Ports (DP) (X108, X109) are standard DP++, with a maximum resolution of 7680 x 4230 at 60 Hz.



Display port ++ supports the use of passive adapters to connect to HDMI or DVI.

---

For the pin assignment of the DP connector, see Chapter 11.4: Display Port Connectors (X108, X109).

### 4.3.8. Breakout Panels (X110, X111) (option)

The two breakout panels (X110 and X111) support factory installed options. The supported breakout panel options are COM (RS232) and Wi-Fi.

#### 4.3.8.1. COM (RS232) (option)

The two serial ports (COM) support RS232 with RX/TX support and no handshaking.

For the pin assignment of the COM connector(s), see Chapter: 11.5.1: Serial Port (COM) Connector (X110, X111).

#### 4.3.8.2. Wi-Fi (option)

The Wi-Fi/Bluetooth® features supported are listed in Table 5: Wi-Fi/BT® Features. The Wi-Fi connectors in the breakout panels are type RP-SMA (female) and required the RP-SMA (male) antenna included in the delivery.

**Figure 7: Connectors and Antenna Type**



Users are responsible for connecting the correct antenna type to the antenna connectors. The antenna position may affect the performance. Do not place the antenna close to a noise source that may cause interference. For spare part information, see Table 2: List of Accessories

For antenna pin information, see Chapter 11.5.2: Wi-Fi/BT® Antenna (X110, X111).

**Table 5: Wi-Fi/BT® Features**

Wi-Fi/BT® Feature	Description
Module	Wi-Fi 6E
Socket Type	M.2 Key E 2230
Channels	2x2 160 MHz
Bandwidth	2.4 Gbps
IEEE Standards	Wi-Fi: 802.11a/b/g/n/ac R2/ax R2 (Pre-Standard)
Bluetooth standard	V5.3
Interface	PCIe x1–Wi-Fi & USB 2.0 - BT
MIMO Support	2x2 MIMO
Security levels	WPA2, WPA3
Wi-Fi Connector	RP-SMA (female)

#### Antenna RF exposure

#### ⚠ CAUTION

- Avoid placing the antenna near people, minimum distance 20 cm.
- Avoid pointing the antenna at people.
- Keep a safe distance from the antenna especially when transmitting.

**NOTICE****RP-SMA and SMA Antenna are not Interchangeable!**

RP-SMA and SMA connectors and antenna are not electrically compatible. Incorrect connection may result in an insufficient connection or destroy the center pin.



Kontron recommends the use of Kontron's reference antenna chosen to meet RF performance requirements and with a nominal impedance of 50 ohms. The reference antennas are included in the delivery and available as an accessory see Table 2: List of Accessories.

## 4.4. Additional Features

### 4.4.1. Automotive Battery (option)

The optional automotive battery is a Real Time Clock (RTC) battery with a lifetime of up to 10 years (3700 days) at a temperature not higher than 25°C. The automotive battery is installed at the factory.

If the automotive battery is installed in a panel mount display of sizes 18.5", 21.5" and 23.8" with the service flap, the service flap can be opened to access and change the automotive battery. For more information. See Chapter 13.3: Exchanging the Automotive Battery (option).

For variants without a service flap the FlatClient must be returned to Kontron to change the automotive battery. For more information see, Chapter 14.1: Returning Defective Merchandise.



An empty RTC lithium battery BIOS does not affect the BIOS settings. However, the system time and date are affected when the RTC lithium battery is empty and must be reconfigured after replacing the battery.

### 4.4.2. RFID-Reader (option)

The RFID reader supports the RFID 13.56 MHz (HF) range and can be installed in combination with Wi-Fi/Bluetooth®.

The RFID-Reader option is factory installed and available for the display size 23.8", other display sizes are on request only, see Chapter 4.4.3: Additional Features (On Request Only).

### 4.4.3. Additional Features (On Request Only)

The following features are available on request only. For more Information regarding on request items, contact your Kontron sales representative.

#### Audio Line-out Jack

- › Enables the connection of external speakers, headphones, or other output devices.

#### CAN BUS

- › Dual CAN bus connector
- › Prerequisite is the Linux (Debian) Operating System

#### Exchangeable Button Cell Battery (type: 2032)

- › Accessible through the service flap (display sizes 18.5", 21.5" & 23.8")
- › Rear panel service flap is mandatory

#### Exchangeable 2.5" SSD SATA III

- › Accessible through the service flap (display sizes 18.5", 21.5" & 23.8")
- › Rear panel service flap is mandatory

### **RFID-Reader**

- › Display sizes 10.1", 12.1", 15.6", 18.5" and 21.5"
- › Located on the front display

## 5/Order Information

**Table 6: Order Number Information**

Product Name	Description
<b><u>2-A1H</u></b> v-yxxx	Flat monitor standard product family
2-A1H <b><u>v</u></b> -yxxx	7: FlatClient PRO RPL 8: FlatClient ECO AML/ADN
2-A1Hv- <b><u>y</u></b> xxx	2: Standard 0: Customer specific product (MOST)
2-A1Hv-y <b><u>xxx</u></b>	Sequential number

# 6/Product Specification

## 6.1. Block Diagram

Figure 8: FlatClient PRO RPL Block Diagram

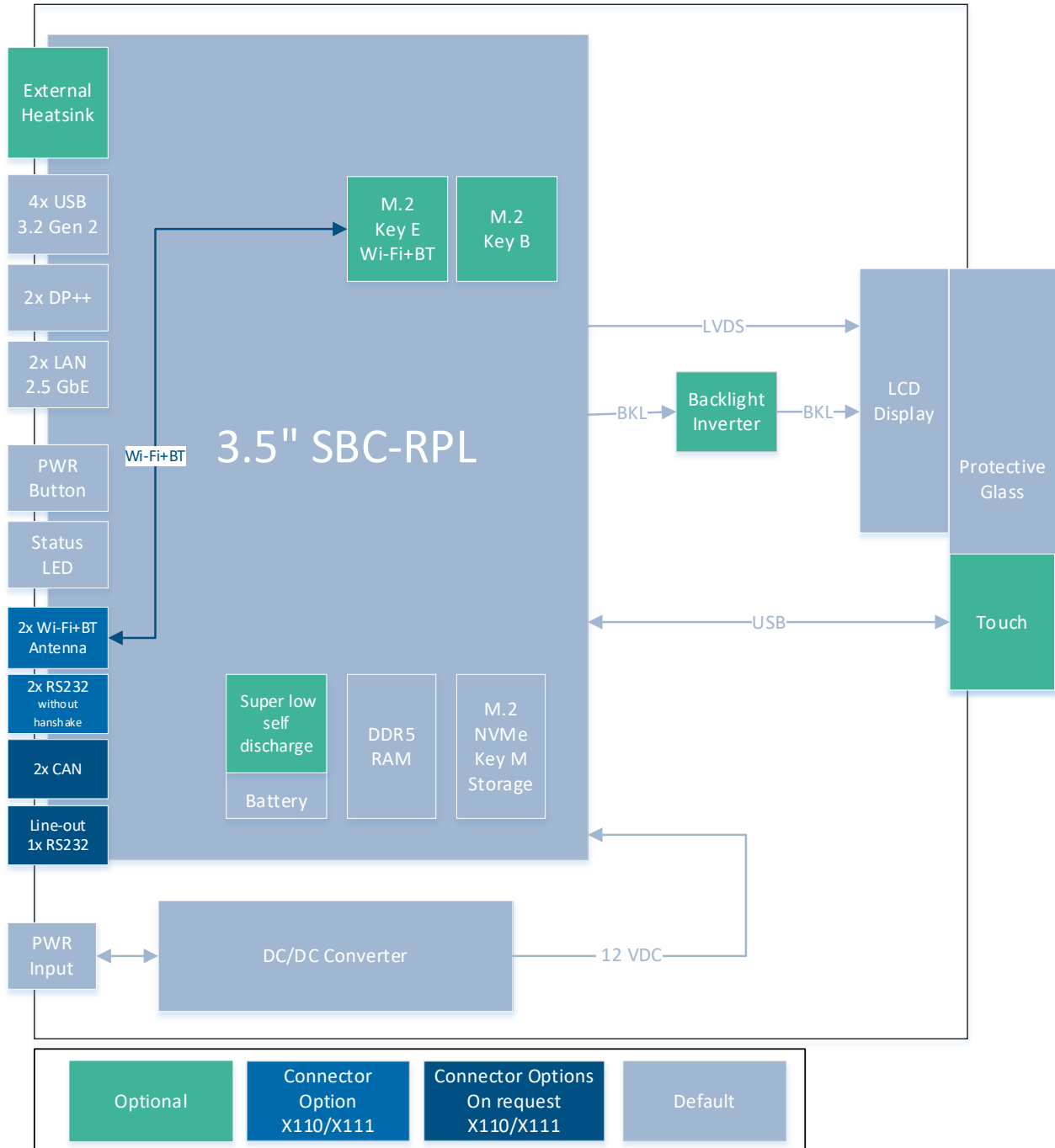

## 6.2. Technical Specifications

**Table 7: Display Specification**

Display	10.1"	12.1"	15.6"
Resolution (pixel)	1280x800	1280x800	1920x1080, Full HD
Format	16:10	16:10	16:9
Contrast Ratio	800:1	1000:1	1000:1
Brightness	500 cd/m <sup>2</sup>	500 cd/m <sup>2</sup>	500 cd/m <sup>2</sup>
Angle View (H/V)	178°/178°	178°/178°	178°/178°
LED Lifetime (> 50%, 25°C)	> 50.000 hr	> 70.000 hr	> 50.000 hr
Dimensions (WxHxD)	276 x 195 x 65 mm	315 x 228 x 65 mm	399 x 260 x 75 mm
Protection Glass	✓	✓	✓
PCAP (Multitouch)	✓	✓	✓
Color	RAL 7021 (black anthracite)		
VESA Stand	VESA 75	VESA 75	VESA 100
Panel Mount Clamping Brackets	Up to 6 (6 min. recommended)	Up to 8 (8 min. recommended)	Up to 16 (12 min. recommended)
Protection Class	Front: IP65, Housing IP20		
Material	VESA: Rear panel stainless steel (RAL 7021 Black Grey) Panel Mount: Rear panel galvanized metal sheet		
Cooling	Fanless passive cooling		

Display	18.5"	21.5"	23.8"
Resolution	1920x1080, Full HD	1920x1080, Full HD	1920x1080, Full HD
Format	16:9	16:9	16:9
Contrast Ratio	1000:1	1000:1	1000:1
Brightness	500 cd/m <sup>2</sup>	300 cd/m <sup>2</sup>	400 cd/m <sup>2</sup>
Angle View	178°/178°	178°/178°	178°/178°
LED Lifetime (> 50%, 25°C)	> 50.000 hr	> 50.000 hr	> 50.000 hr
Dimensions (WxHxD)	465 x 299 x 75 mm	533 x 339 x 75 mm	575 x 364 x 75 mm
Protection Glass	✓	✓	✓
PCAP (Multitouch)	✓	✓	✓
Color	RAL 7021 (black anthracite)		
Mounting (VESA)	VESA 100	VESA 100	VESA 100
Panel Mount Clamping Brackets	Up to 16 (14 min. recommended)	Up to 16 (14 min. recommended)	Up to 16 (14 min. recommended)
Protection Class	Front: IP65, Housing IP20		
Material	VESA: Rear panel stainless steel (RAL 7021 Black Grey) Panel Mount: Rear panel galvanized metal sheet		
Cooling	Fanless passive cooling		

**Table 8: Hardware Specification**

FlatClient PRO RPL	Description			
Board	3.5"-SBS-RPL			
Processor	<b>Type</b>	<b>Cores</b>	<b>Speed</b>	<b>TDP max</b>
	Intel® U300	5	Up to 4.4 GHz	25 W
	Intel® Core™ i3-1315UE	6	Up to 4.5 GHz	25 W
	Intel® Core™ i5-1345UE	10	Up to 4.6 GHz	25 W
	Intel® Core™ i7-1365UE	10	Up to 4.9 GHz	25 W
System Memory	Up to 64 GByte max. 2x DDR5 SO-DIMM (options: 1x 8 GByte, 1x 16 GByte, 2x 16 GByte, 2x 32 GByte)			
Storage	1x M.2 2280 NVMe SSD (128 Gbyte, 256 Gbyte, 512 Gbyte, 1 TByte)			
Graphics	Intel® Iris Xe Graphics or Intel® UHD Graphics Max. DP Resolution: 7680 x 4320@60 Hz			
I/O (Standard)	2x 2.5 GbE 4x USB 3.2 Gen 2 2x DP++			
RTC	Integrated: lifetime 3 years (min.) at temperatures not higher than 25°C			
Options	<p>COM</p> <ul style="list-style-type: none"> <li>➤ Up to 2x COM (RS232)</li> <li>➤ Available on the interface panel breakout (X110, X111)</li> </ul> <p>Wi-Fi</p> <ul style="list-style-type: none"> <li>➤ 2x Wi-Fi /BT® antenna</li> <li>➤ Available on the interface panel breakout (X110, X111)</li> </ul> <p>Automotive battery</p> <ul style="list-style-type: none"> <li>➤ Lifetime 10 years (3700 days) @ temperature &lt;25°C</li> <li>➤ For Panel mount display sizes 18.5", 21.5" and 23.8" only</li> </ul> <p>RFID</p> <ul style="list-style-type: none"> <li>➤ Wide range of RFID technologies at 13.56 MHz (HF)</li> <li>➤ For display size 23.8"</li> </ul>			
On Request	<p>The following options are available on request only:</p> <p>Audio Line-out</p> <ul style="list-style-type: none"> <li>➤ Stereo 3 W, on the interface panel breakout (X110, X111)</li> </ul> <p>Dual CAN bus connector</p> <ul style="list-style-type: none"> <li>➤ For Linux (Debian) OS only on the interface panel breakout (X110, X111)</li> </ul> <p>RFID</p> <ul style="list-style-type: none"> <li>➤ Display sizes 10.1", 12.1", 15.6", 18.5" and 21.5"</li> </ul> <p>Exchangeable button cell battery (type: 2032)</p> <ul style="list-style-type: none"> <li>➤ Accessible through the service flap (display sizes 18.5", 21.5" &amp; 23.8")</li> <li>➤ Mandatory service flap</li> </ul> <p>Exchangeable 2.5" SSD SATA III</p> <ul style="list-style-type: none"> <li>➤ Accessible through the service flap (display sizes 18.5", 21.5" &amp; 23.8")</li> <li>➤ Mandatory service flap</li> </ul> <p>For On Request Option information, contact your Kontron sales representative.</p>			

## 6.3. Software Specification

**Table 9: Software Specification**

FlatClient PRO RPL	Description
BIOS	AMI uEFI BIOS
Operating System (OS)	Windows 10 IoT / 11 IoT Linux (Debian) Kontron OS – hardened & secure Linux®-based Operating System (on request only) QIWI toolkit – for WEB panel operation



For the available BIOS updates and Board Support Packages (BSP), visit Kontron's [Customer Section](#).

## 6.4. Environmental Specification

**Table 10: Environmental Specification**

FlatClient PRO RPL		Description
Temperature	Operating	0°C to 50°C (32°F to 122°F)
	Storage	-20°C to 70°C (-4°F to 158°F)
Humidity (relative)		93% @ 40°C, non condensing
Altitude		Up to 3000 m (9900 ft.)
Shock, according to EN 60068-2-27	Operating	15 G, 11 ms duration (half sine), shock count 3/direction, total 18
	Storage	30 G, 11 ms duration (half sine) shock count 3/direction, total 18
Vibration, according to EN 60068-2-6	Operating	10-500 Hz: 1 G
	Storage	10-500 Hz: 2 G

### Indoor Use Only

The product is intended for indoor use only. To avoid product damage, do not use the product in a sheltered outdoor, outdoor or sunlit environment.

Observe that the product is not exposed to direct sunlight (UV radiation):

### NOTICE

- Prolonged exposure shortens field life and invalidates the warranty
- Short exposure may lead to higher temperatures inside the product and cause permanent damage
- Direct exposure accelerates long-term aging

For intend use in an outdoor environment or a sunlit environment, contact your Kontron sales representative.

## 6.5. Power Specification

Before connecting the product to an external 24 VDC power supply, ensure that the power supply meets the electrical specification for the product as specified in this user guide and documented on the product's Type Label, and that protection and supply limitation have been taken into consideration. The power supply must automatically recover from AC power loss and start up under peak loading. Connect the product only to a power supply designed to achieve NEC Class-2 and Limited Power Source (LPS) and used according to the manufacturer's instructions.

### ⚠ CAUTION

#### External Power Supply

Only connect the product to an external power supply providing the voltage type (AC or DC) and the Power IN (max. current) specified on the Kontron Product Label.

The external power supply must meet the requirements of ES1/PS2 according to IEC/UL 62368-1.

### ⚠ CAUTION

#### Disconnection Device

Observe that wiring and short-circuit/overcurrent protection is performed according to the applicable standards, regulations and in respect to the product's electrical specification. The disconnecting device (fuse/circuit breaker) rating must be in accordance with the product's wire cross-section.

### NOTICE

#### Avoid Forced Shutdown

Do not disconnect the power while the product is operating!

Performing a forced shut down can lead to loss of data or other undesirable effects!

### NOTICE

#### Minimum Immunity

Ensure the external DC power supply has been fully tested to meet the minimum immunity of AC inputs requirements, as stipulated in IEC 55024. Including power supplies marketed with a separate AC/DC power converter.

**Table 11: Electrical Specification 24 VDC**

Electrical Specification	Description
Input Voltage	24 VDC, Range: 12 VDC to 34 VDC (36 VDC max.)
Power	90 W max.

The following table provides the typical power consumption at typical load during burn in, with 50 % processor and RAM, 2D, 3D and disk test 50% (for internal M.2 SSD) and max. display brightness and nominal 15 W TDP Power.

**Table 12: Typical Power Consumption @ Typical Load and 24 VDC**

Display Size	Processor Platform RPL
10.1"	27.8 W
12.1"	33.9 W
15.6"	36.6 W
18.5"	46.2 W
21.5"	37.5 W
23.8"	46.3 W

### 6.5.1. Power Supply Protection Requirements

The external DC power supply is required to incorporate protection and supply features such as over current protection, inrush current protection, over voltage protection and under voltage (brownout) protection, to protect the product against fluctuations and interruptions in the delivered DC power supply.

---

**NOTICE****Power Cables**

To protect the product and any connected peripherals, make sure that the power cables have the right diameter to withstand the maximum available current.

---

**NOTICE****Brownout**

If there is an unintentional voltage drop in the mains power supply for longer than the specified holdup time (brownout), all supply voltages should be shut down and remain in the off state long enough to allow internal voltages to discharge sufficiently. During the off-state time do not disconnect or add cables to/from the I/O connectors. Failure to observe the off-state time means that parts of the product or attached peripherals may work incorrectly or suffer a reduction of MTBF.

The minimum off state time, to allow internal voltages to discharge, depends on the power supply used and additional electrical factors. To determine the required off state time, each case must be considered individually. For more information, contact [Kontron Support](#).

---

### 6.5.2. Functional Earth Bolt

The functional earth bolt connects to the internal shield.

**CAUTION****Ground Properly**

The installation sites ground must meet your local, national and international region grounding requirements.

---

To avoid damage to the product, observe proper grounding methods:

1. Connect the product to ground before switching on the product.
2. Only connect the product to an applied ground that meets all applicable local, national and international grounding requirements.
3. When assembling, connect the first cable to the functional earth bolt and when disassembling, the last cable to be removed is the ground cable.

## 6.6. Compliance

The FlatClient PRO RPL plans to comply with the relevant requirements and the approximation of the laws relating to 'CE' or 'CE RED' and the standards that are constitutional parts of the declaration.

**Table 13: Compliance CE Mark**

Europe – CE Mark	
<b>Directives</b>	<b>2014/30/EU</b> Electromagnetic compatibility <b>2014/35/EU</b> Low Voltage <b>2011/65/EU</b> RoHS II Restriction of the use of Hazardous Substances in electrical and electronic equipment
<b>EMC</b>	<b>EN 55032</b> Electromagnetic compatibility of multimedia equipment – Emission requirements <b>EN 61000-6-2</b> Electromagnetic compatibility (EMC), Part 6-2: Generic Standards - Immunity for industrial environments
<b>Safety</b>	<b>EN 62368-1</b> Audio/video, information and communication technology equipment – Part 1: Safety requirements

**Table 14: Compliance CE RED Mark**

Europe – CE RED Mark	
<b>Directives</b>	<b>2014/53/EU</b> RED: Radio equipment Directive <b>2011/65/EU</b> RoHS II Restriction of the use of Hazardous Substances in electrical and electronic equipment
<b>EMC</b>	<b>EN 55032</b> Electromagnetic compatibility of multimedia equipment – Emission requirements <b>EN 61000-6-2</b> Electromagnetic compatibility (EMC), Part 6-2: Generic Standards - Immunity for industrial environments
<b>Radio</b>	<b>EN 301 893 V2.1.1</b> 5 GHz RLAN - Harmonized Standard covering the essential requirements of article 3.2 of Directive 2014/53/EU <b>EN 303 687 V1.1.1</b> 6 GHz WAS/RLAN - Harmonized Standard for access to radio spectrum <b>EN 300 328 V2.2.2</b> Wideband transmission systems; Data transmission equipment operating in the 2,4 GHz ISM band and using wide band modulation techniques <b>EN 300 330 V2.1.1</b> Short Range Devices (SRD); Radio equipment in the frequency range 9 kHz to 25 MHz and inductive loop systems in the frequency range 9 kHz to 30 MHz <b>EN 62311</b> Assessment of electronic and electrical equipment related to human exposure restrictions for electromagnetic fields (0 Hz - 300 GHz)

Europe – CE RED Mark	
<b>Safety</b>	<b>EN 62368-1</b> Audio/video, information and communication technology equipment – Part 1: Safety requirements

The FlatClient PRO RPL plans to comply with the following International specific certifications.

**Table 15: Compliance International**

USA/CANADA	
<b>EMC</b>	<b>FCC 47 CFR Part 15 (Class B)</b> Complies with part 15 FCC rules and regulations of title 47 of the CFR rules for class B products; under which an unintentional radiator may be operated, administrated and other conditions relating to the marketing of part 15 devices.
<b>Safety</b>	<b>UL 62368-1/CSA-C22.2 No. 62368-1</b> Audio/video, information and communication technology equipment – Part 1: Safety requirements
UK CA (UK Conformity Assessed)	
<b>EMC</b>	<b>EN 55032</b> Electromagnetic compatibility of multimedia equipment – Emission requirements <b>EN 61000-6-2</b> Electromagnetic compatibility (EMC), Part 6-2: Generic Standards - Immunity for industrial environments
<b>Safety</b>	<b>EN 62368-1</b> Audio/video, information and communication technology equipment – Part 1: Safety requirements
International Certifications	
<b>Safety</b>	<b>IEC 62368-1</b> Audio/video, information and communication technology equipment – Part 1: Safety requirements



If the product is modified, the prerequisites for specific approvals may no longer apply.



For the product's Declaration of Conformity (DoC), visit Kontron's [Customer Section](#).



Kontron is not responsible for any radio television interference caused by unauthorized modifications of the delivered product or the substitution or attachment of connecting cables and equipment other than those specified by Kontron. The correction of interference caused by unauthorized modification, substitution or attachment is the user's responsibility.

## 7/Thermal and Power Management

### 7.1. Passive Cooling

The FlatClient PRO RPL panel mount and VESA variants are both passively cooled. The entire rear panel surface can get hot, and precautions must be taken before handling or touching. Do not obstruct the airflow around the rear panel as this may cause a build-up of heat. Observe the specified minimum clearance distance around the FlatClient, see Chapter 7.4: Minimum Clearance.

Both the panel mount and VESA variants support the installation of an optional heatsink for a more efficient path for the transfer of heat out of the product and into the ambient surrounding environment.



#### Caution: Hot Surface

The rear panel can get hot. To avoid burns and personal injury when handling the rear panel:

- › Do not touch while in operation
- › Allow to cool before handling
- › Wear protective gloves

The product's operating range is 0°C to 50°C (32°F to 122°F). However, when operated at temperatures above 35°C (95°F) the performance of the processor reduces, see Figure 9, Blue line. Full performance over the operating temperature range may require the installation of a heatsink on the rear panel, to enable sufficient heat dissipation into the environment, see Figure 9, green line.

Figure 9: Performance vs Temperatures (35°C /95°F), 50°C /122°F)

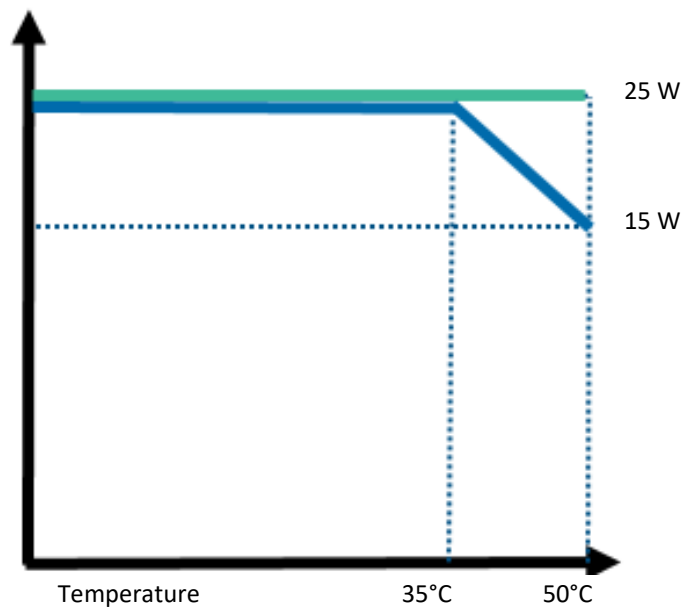

### 7.2. Heatsink (optional)

A heatsink installed on the rear panel is available for both the panel mount and VESA variants to improve the thermal performance of the FlatClient. Do not obstruct the airflow around the heatsink as this may cause a build-up of heat. Observe a minimum clearance distance around the product, see Chapter 7.4: Minimum Clearance.



### Hot Surface

Heatsinks can get hot. To avoid burns and personal injury when handling the heatsink:

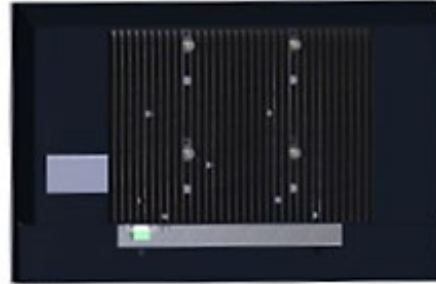

- Do not touch while in operation
- Allow to cool before handling
- Wear protective gloves

Figure 10: Rear Panel (panel mount and VESA) with Heatsink

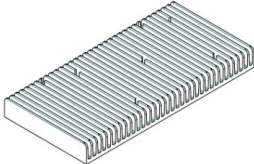

The heatsink's mechanical specifications differ depending on the type of rear panel and the display size. All heatsinks add an additional 25 mm (0.99 inch) to the FlatClient's overall depth.

Table 16: Heatsink Dimensions

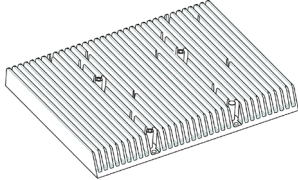
Display Size	Panel Mount Heat sink	VESA Heat Sink
10.1	245 mm x 120 mm x 25 mm (9.65 inch x 4.72 inch x 0.99 inch)	245 mm x 120 mm x 25 mm (9.65 inch x 4.72 inch x 0.99 inch)
12.1		
15.6		245 mm x 180 mm x 25 mm (9.65 inch x 7.09 inch x 0.99 inch)
18.5		
21.5		
23.8		

### 7.3. Mount Orientation

The product is designed for vertical operation (+/-25°) and intended for indoor use only without exposure to direct sunlight (UV radiation). When mounting the product take care not to obstruct the airflow over the rear side, as this can stop sufficient heat dissipating into the ambient environment and cause a build-up of heat. For more information, see Chapter 9/: Installation.

#### Mounting Considerations

Users must ensure the following:

#### NOTICE

- Mount the product in the vertical position +/-25°
- Observe a suitable clearance distance all around the product
- Provide sufficient ventilation
- Ensure no other devices heat up the product

### 7.4. Minimum Clearance

To provide maximum airflow away from the product's rear panel a minimum clearance distance (keep out area) of 20 mm (0.79 inch) to the surrounding environment (with/without heatsink) must be observed, also known as keep out area in this user guide.

#### NOTICE

Ensure proper operation by observing a suitable minimum clearance distance of 20 mm (0.79 inch) at the rear side of the product.

### 7.5. Maximum Processor Power and Temperature

The Intel® processor series used provides internal thermal monitoring with a temperature sensor. To allow for optimal operation and long-term reliability, the processor must operate in the specified temperature range. To avoid overheating the processor performs automatic thermal management, to keep the processor temperature below the highest value of the temperature range.

**Table 17: Processor TDP and Maximum Temperatures**

Processor	Description	Power	Temperature	
			TDP <sup>[1]</sup>	DTR
Intel® U300E	5 Cores, 8 MB Cache and up to 4.3 GHz	25 W	+/-70°C (158°F)	100°C (212°F)
Intel® Core™ i3-1315UE/URE	6 Cores, 10 MB Cache and up to 4.5 GHz	25 W	+/-70°C (158°F)	100°C (212°F)
Intel® Core™ i5- 1345UE/URE	10 Core, 12 MB Cache and up to 4.6 GHz	25 W	+/-70°C (158°F)	100°C (212°F)
Intel® Core™ i7- 1365UE/URE	10 Core, 12 MB Cache and up to 4.9 GHz	25 W	+/-70°C (158°F)	100°C (212°F)

<sup>[1]</sup> TDP High power



Dynamic Temperature Range (DTR) defines the maximum temperature range during operation starting from boot time temperature and within the T-Junction limits. For further DTR information for your processor or a higher DTR-value, contact [Kontron Support](#).



T-Junction is the maximum junction temperature allowed at the processor die.

## 7.6. Power Consumption and Thermal Monitoring

The Intel® processor series used provides settings for maximal power consumption to help limit the thermal load. Changing these settings influences the performance of the application. The product's ambient maximum temperature depends mainly on the power consumption of the processor and chipset and installed M.2 modules and connected USB devices. Typical power consumption values are provided in Chapter 6.5: Power Specification.



The maximum system ambient temperature depends mostly on the power consumption of the processor, chipset and third-party components such as M.2 modules and USB devices.

## 7.7. Derating TDP Curves

The derating TDP curves show how TDP power dissipation reduces to prevent overheating as the surrounding ambient temperature rises. The reference derating TDP curves act as a guideline to help users set TDP power limits to maintain safe operating conditions for the product's various load configurations.

To configure the TDP power limits, see Chapter 7.8: Configuring the Processor TDP.

The derating TDP curves consider the absolute maximum configuration and reduced configurations without external load and additionally without M.2 modules and external load.

## 7.8. Configuring the Processor TDP

The TDP can be configured in the BIOS Advanced setup menu, using the Configurable TDP Boot Mode, see Figure 18: Advanced Setup Menu Example. The BIOS default setting is [nominal] and possible BIOS settings are [Nominal, Low Level, High Level], see Table 27: Advanced Setup Menu Sub-screens.

## 7.9. Third Party Components

The product is factory configured as ordered and requires no further hardware configuration with third party components by the user. Opening the product to configure additional third-party components invalidates the warranty and the user must consider that an approximate internal temperature rise occurs. In this case, to avoid overheating the user is responsible for including an adequate cooling solution for any additional third-party components to absorb and transfer the excess heat produced.

### **NOTICE**

#### **Protection Label**

The product is factory configured to meet customer requirements and then sealed with a protection label. Opening the product may damage internal components and invalidate the warranty.

## 8/Mechanical Specification

The FlatClient PRO RPL is available with display sizes 10.1", 12.1", 15.6", 18.5", 21.5" and 23.8".

This chapter provides an overview of the mechanical dimension for each display size and gives the panel cutout dimension, and the mounting bracket height requirements when mounting each of the display sizes. The dimensions are without a heatsink. If the heatsink option is included, the depth increases by 25 mm.

**Table 18: Mechanical Dimensions Overview**

Panel Mount						
Display Size	Width		Height		Depth (no heatsink)	
	mm	inch	mm	inch	mm	inch
10.1"	276.5	10.88	195.2	7.69	64.45	2.54
12.1"	315.5	12.42	228	8.97	64.45	2.54
15.6"	399	15.71	260	10.24	75.1	2.96
18.5"	465.3	18.32	299	11.77	75.1	2.96
21.5"	532.5	20.96	338.5	13.33	75.05	2.95
23.8"	575.1	22.64	364.9	14.37	75.01	2.95

VESA						
Display Size	Width		Height		Depth (no heatsink)	
	mm	inch	mm	inch	mm	inch
10.1"	276.5	10.88	195.2	7.69	64.5	2.54
12.1"	315.5	12.42	228	8.97	64.45	2.54
15.6"	399	15.71	260	10.24	73.85	2.91
18.5"	465.3	18.32	299	11.77	73.85	2.91
21.5"	532.5	20.96	338.5	13.33	73.85	2.91
23.8"	575.1	22.64	364.9	14.37	73.85	2.91

For mechanical drawings and 3D files and panel cutout dimensions for each display size, visit Kontron's [Customer Section](#) to access the FlatClient PRO RPL Mechanical Drawings and 3D Files information.



If you need to register as a new customer, fill out and send the registration form. The login password will be sent to you within a maximum of 72 hours.

### 8.1. 10.1" Panel Mount

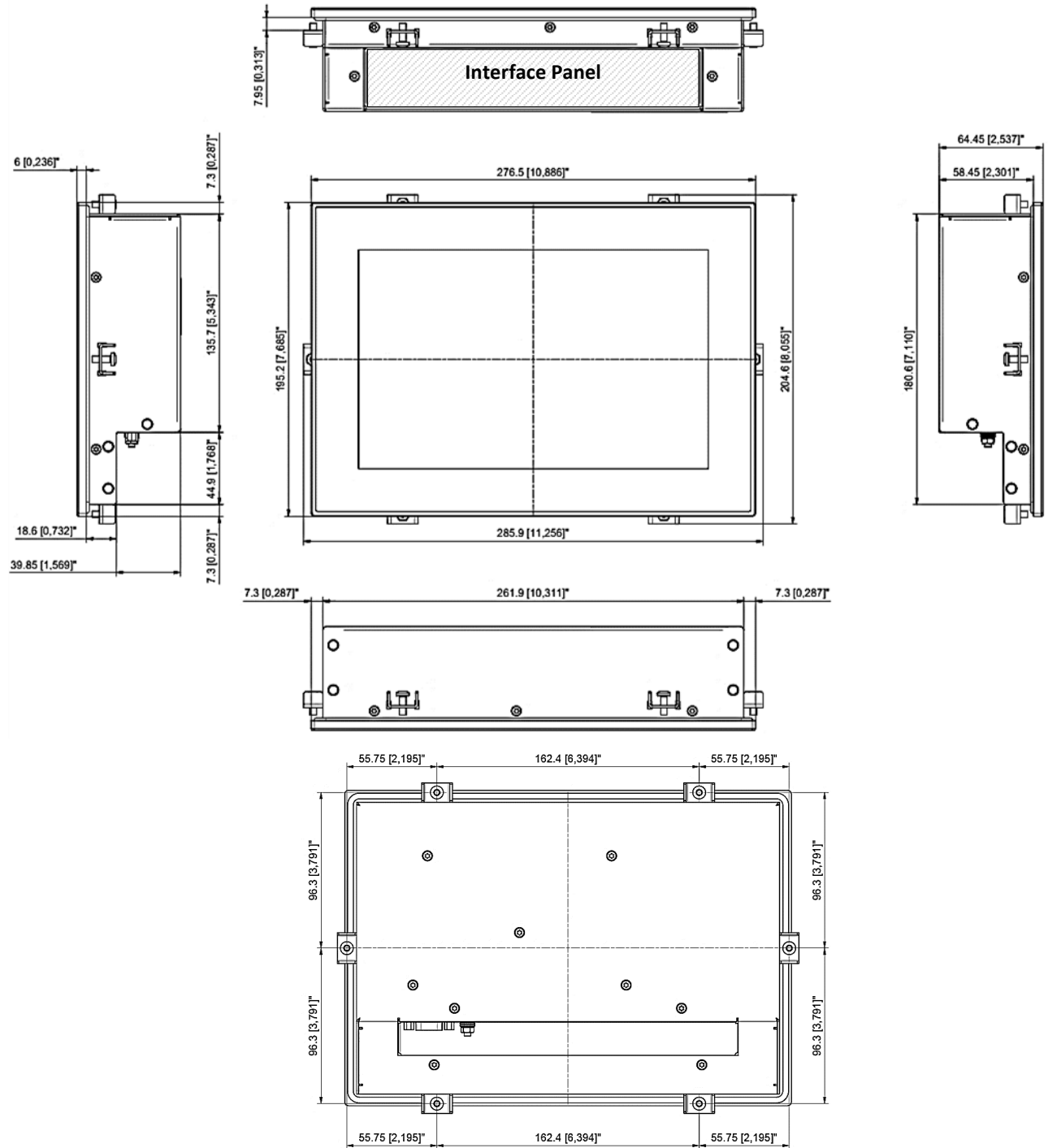

Dimensions	Panel Cutout Horizontal	Panel Cutout Vertical	Height for Mounting Brackets (max.)
10.1" Display	263.9 mm [10.390"]	182.6 mm [7.189"]	5.00 mm [0.197"]

## 8.2. 10.1" VESA

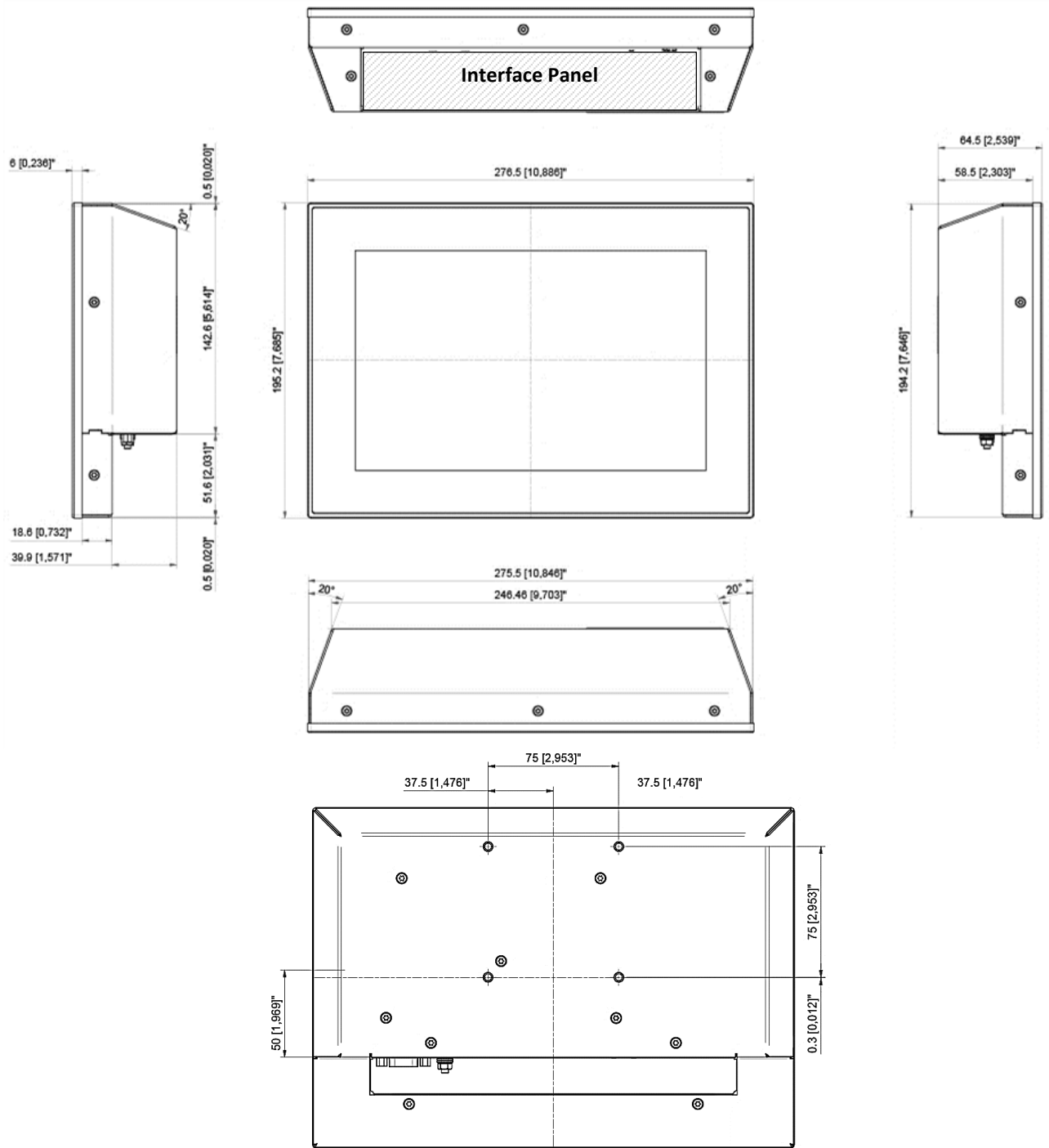

For the mechanical drawings and 3D Files, visit Kontron's [Customer Section](#).

### 8.3. 12.1" Panel Mount

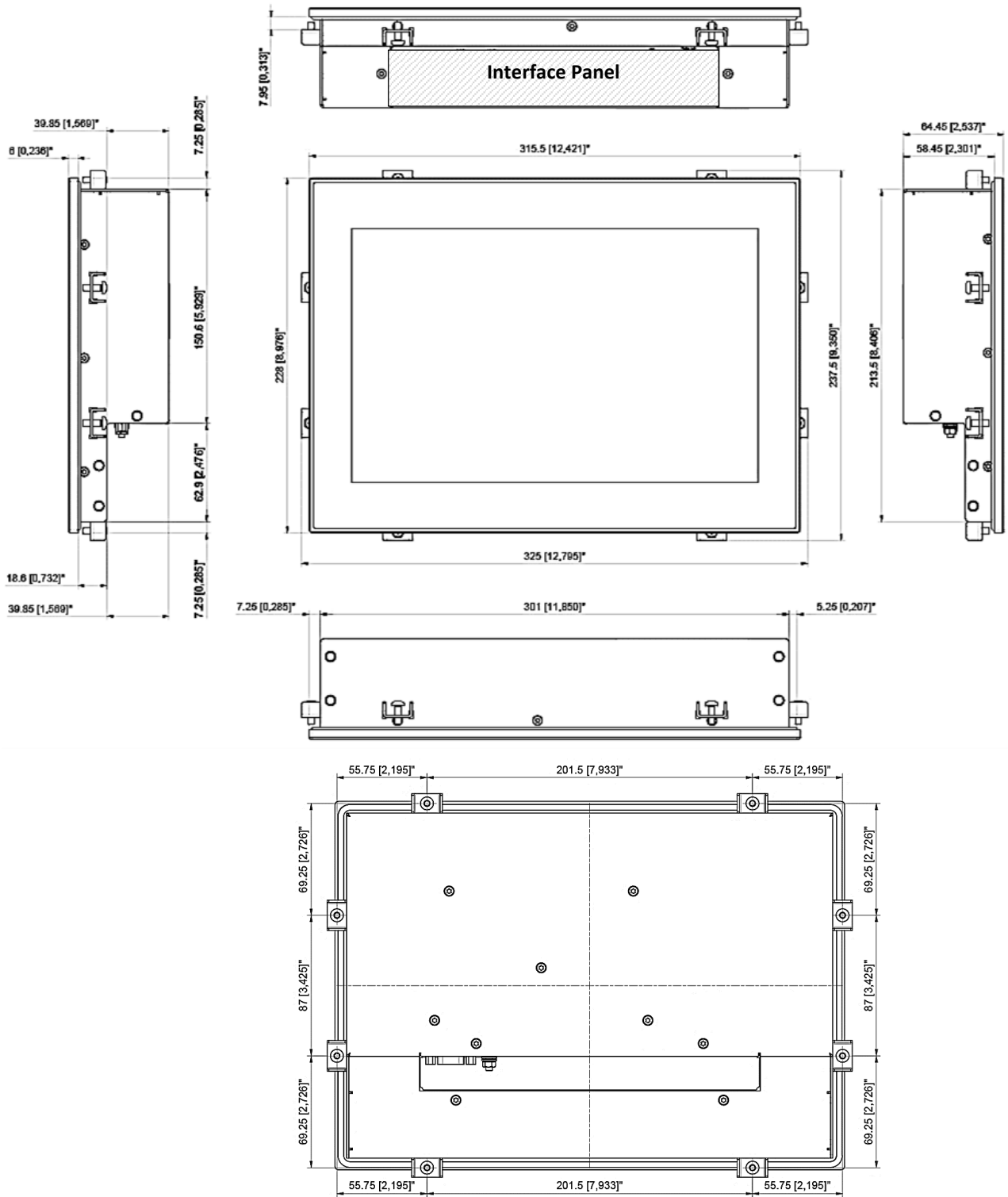

Dimensions	Panel Cutout Horizontal	Panel Cutout Vertical	Height for Mounting Brackets (max.)
12.1" Display	303 mm [11.929"]	215.5 mm [8.484"]	5.00 mm [0.197"]

### 8.4. 12.1" VESA

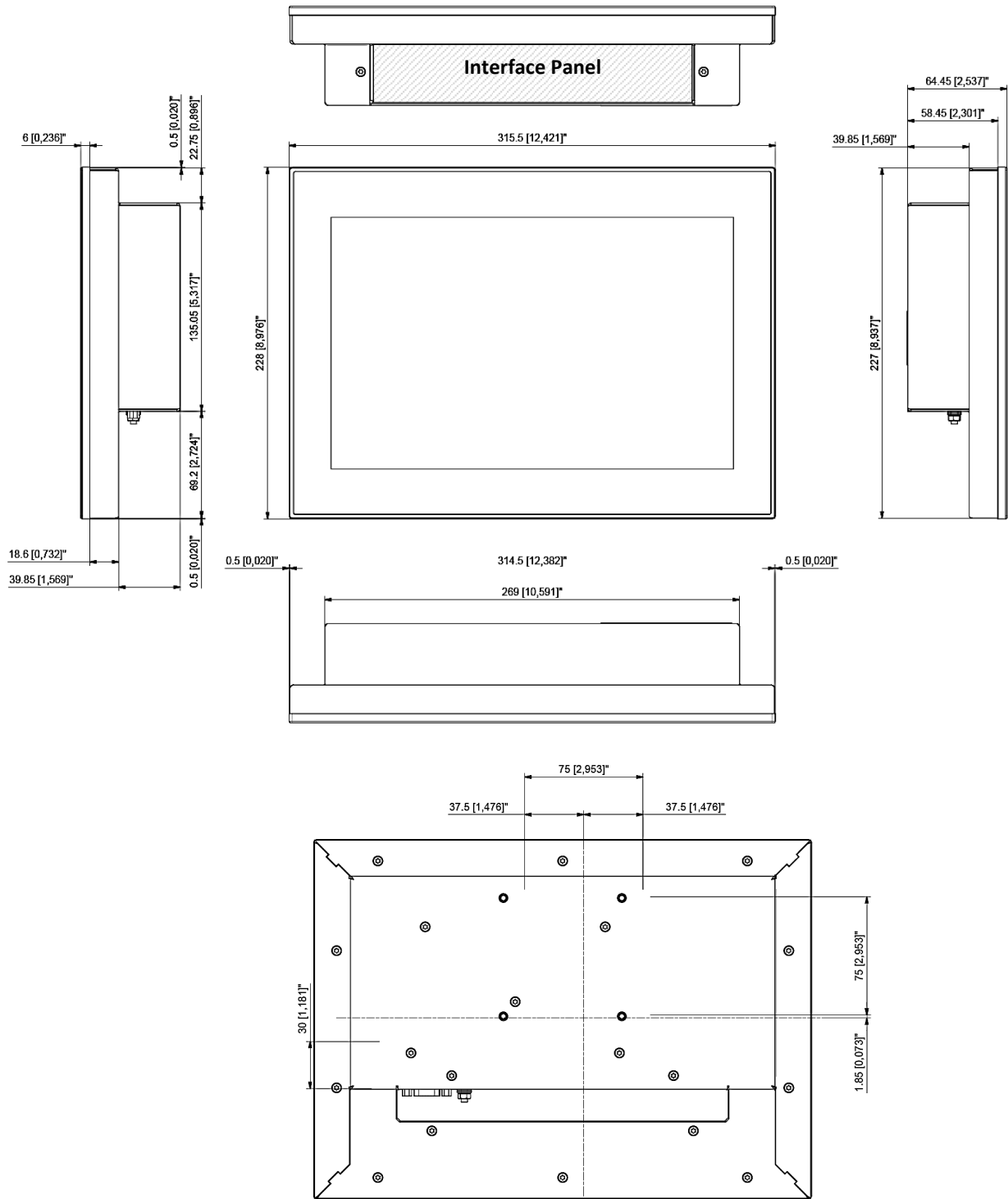

For the mechanical drawings and 3D Files, visit Kontron's [Customer Section](#).

### 8.5. 15.6" Panel Mount

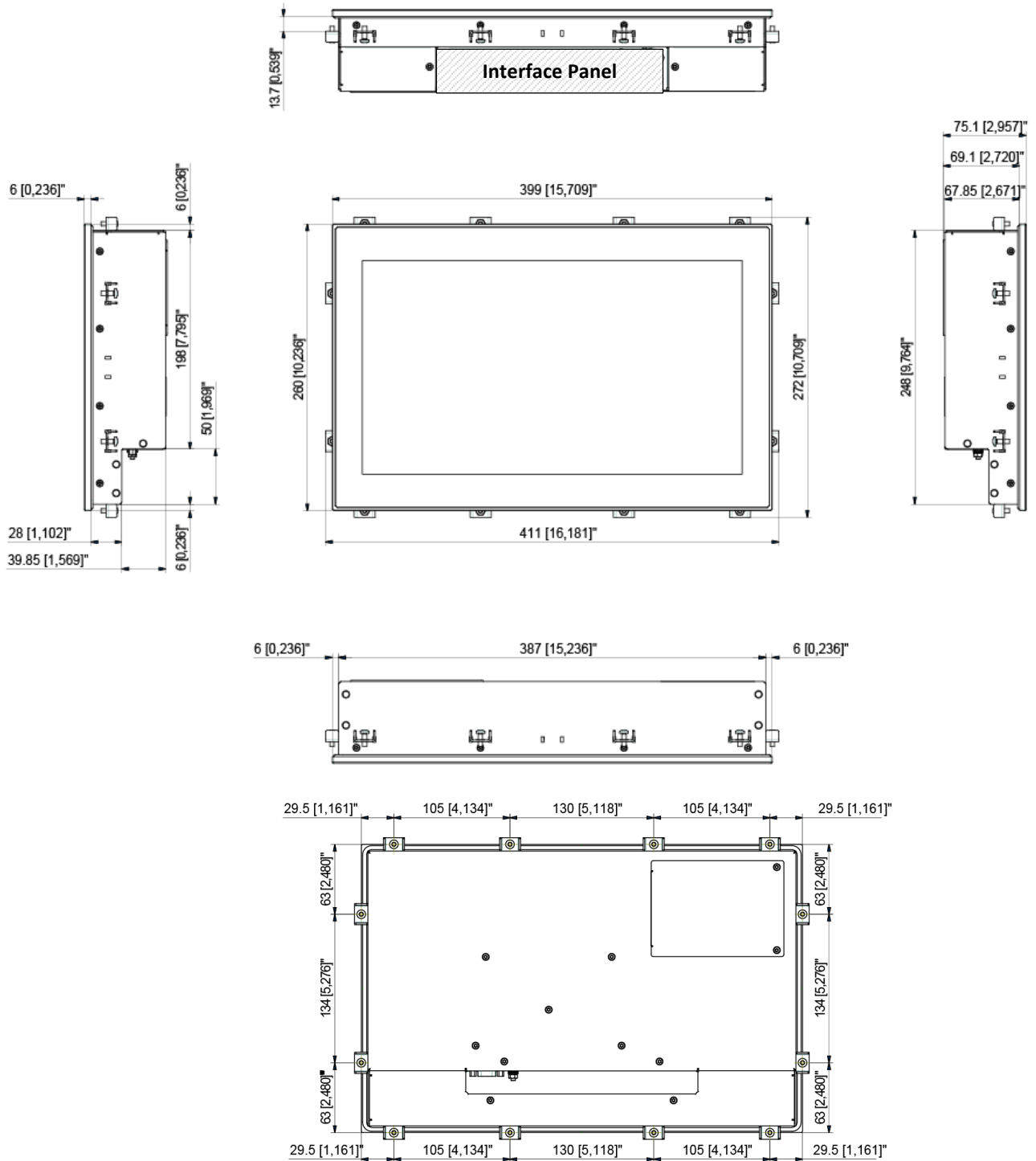

Dimensions	Panel Cutout Horizontal	Panel Cutout Vertical	Height for Mounting Brackets (max.)
15.6" Panel	389 mm [15.315"]	250 mm [9.843"]	10.75 mm [0.423"]

## 8.6. 15.6 VESA

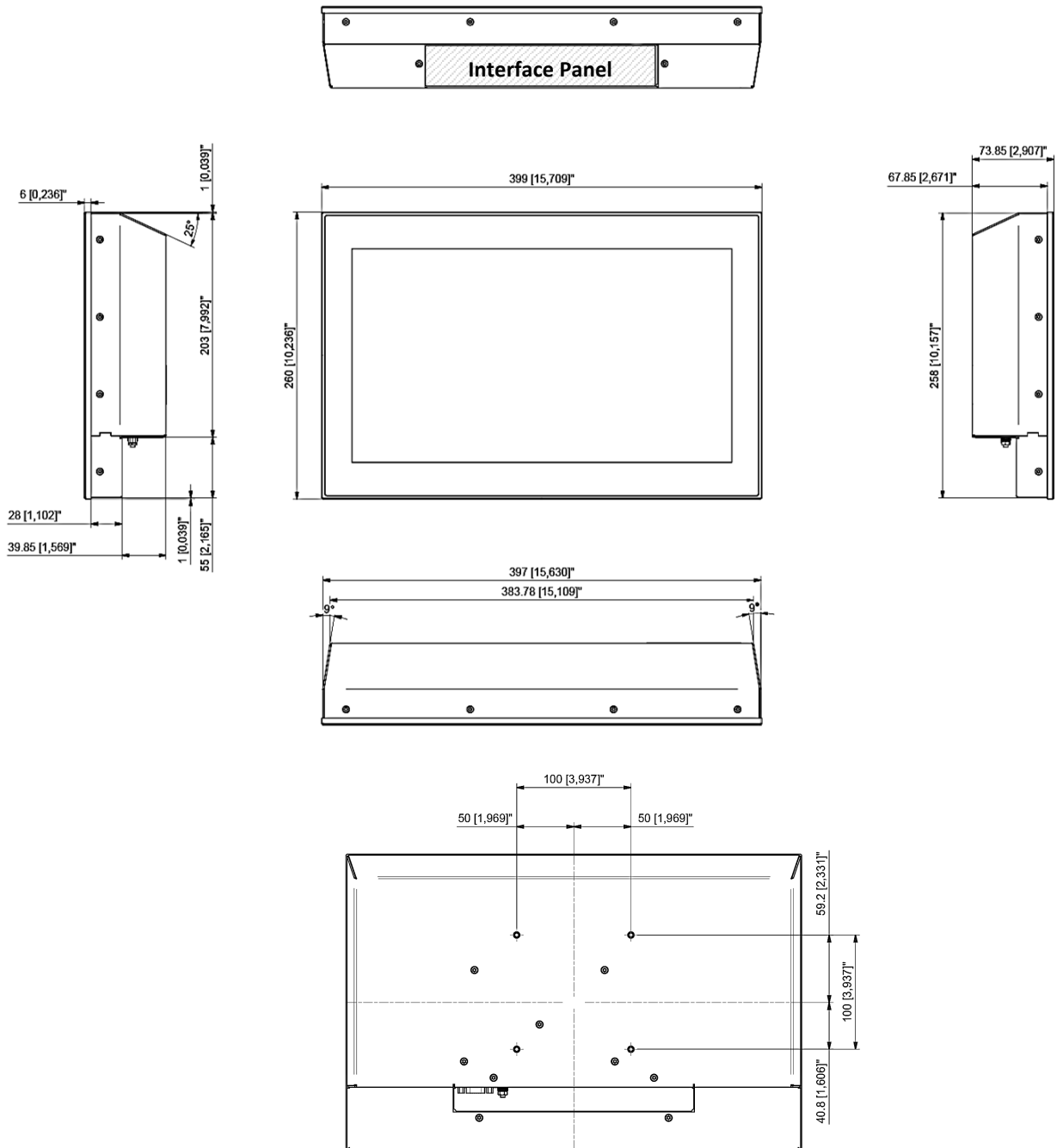

For the mechanical drawings and 3D Files, visit Kontron's [Customer Section](#).

### 8.7. 18.5" Panel Mount

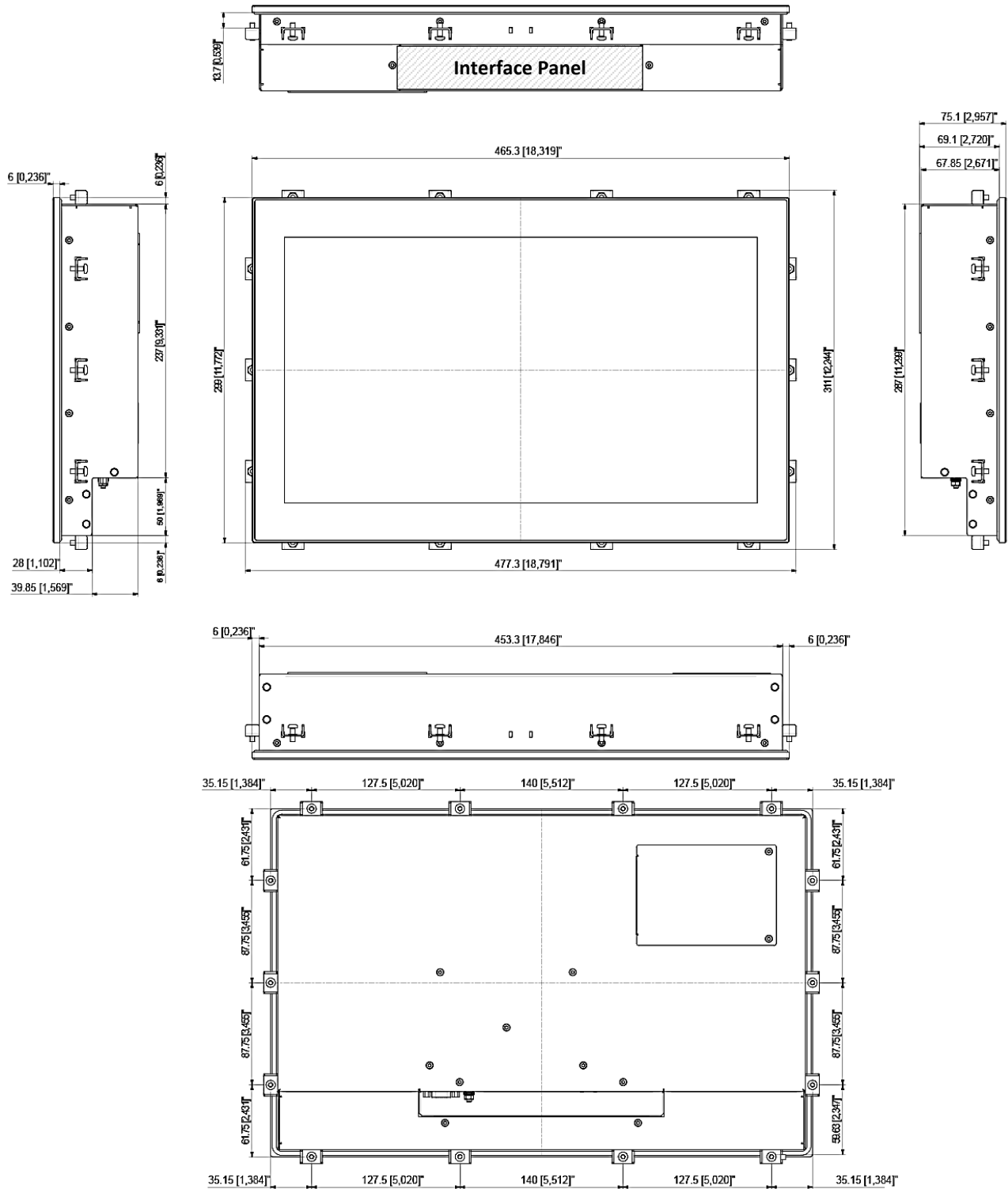

Dimensions	Panel Cutout Horizontal	Panel Cutout Vertical	Height for Mounting Brackets (max.)
18.5" Display	455.3 mm [17.925"]	289 mm [11.378"]	10.75 mm [0.423"]

## 8.8. 18.5" VESA

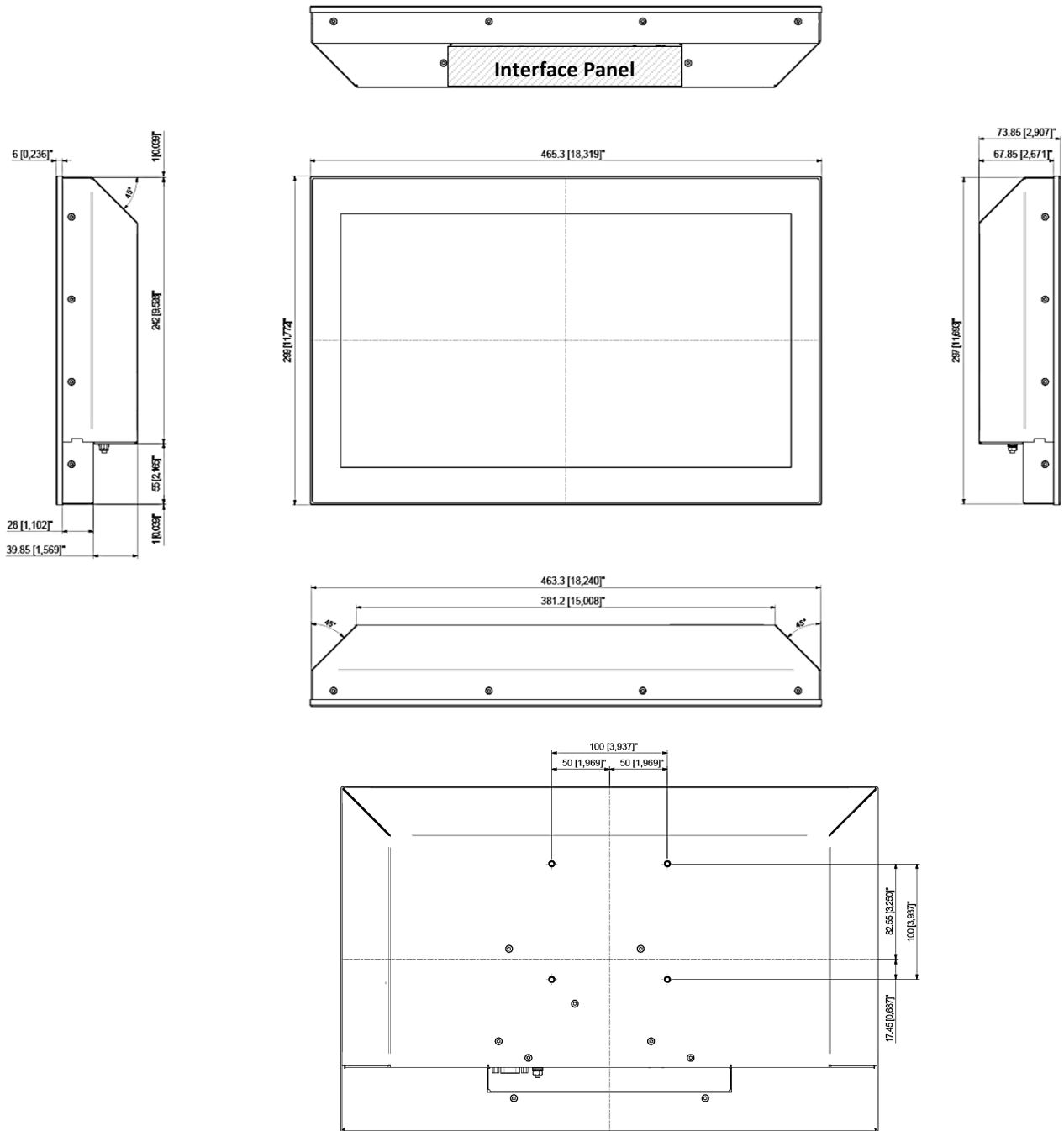

For the mechanical drawings and 3D Files, visit Kontron's [Customer Section](#).

### 8.9. 21.5" Panel Mount

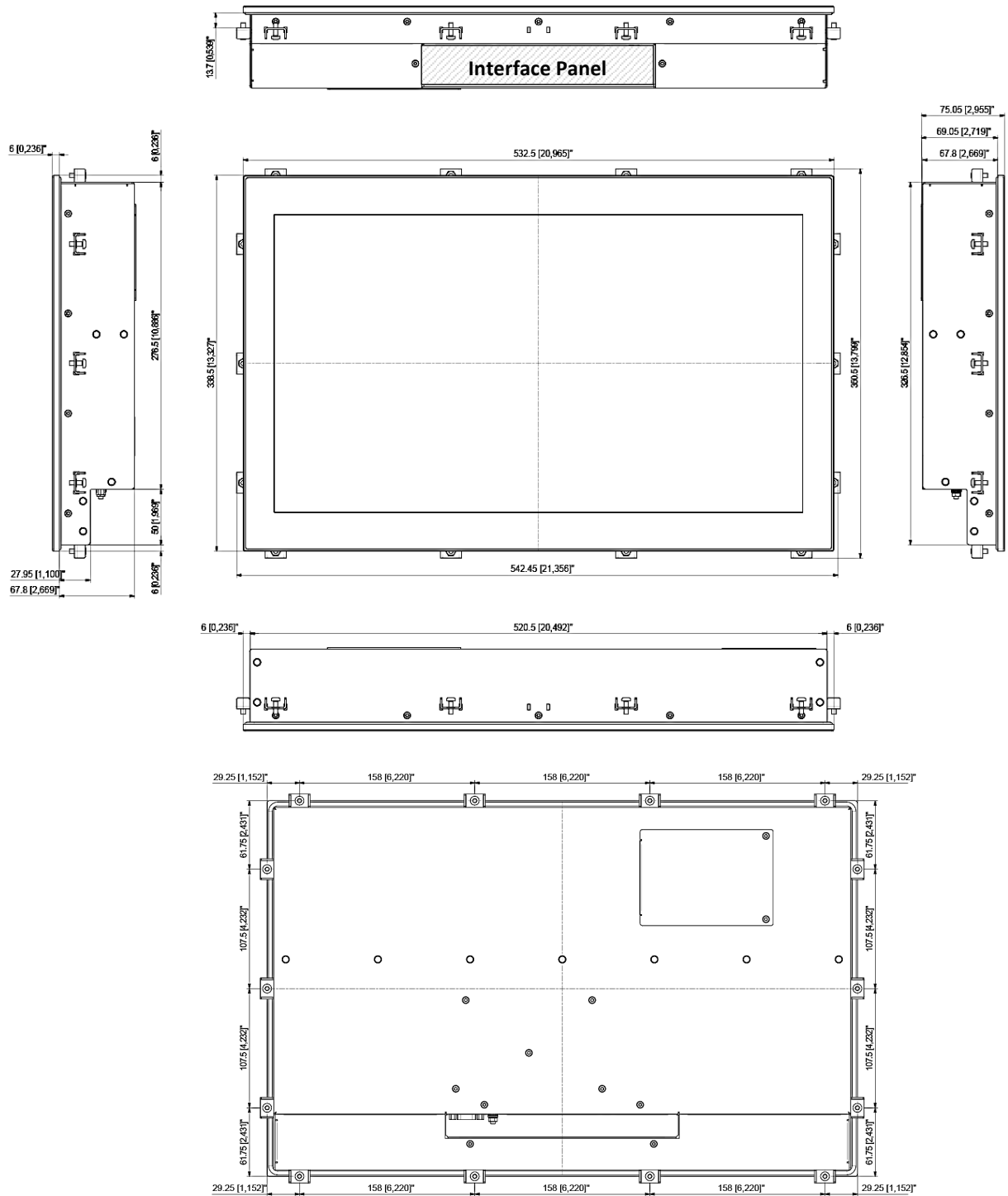

Dimensions	Panel Cutout Horizontal	Panel Cutout Vertical	Height for Mounting Brackets (max.)
<b>21.5" Display</b>	522.5 mm [20.571"]	328.5 mm [12.933"]	10.75 mm [0.423"]

## 8.10. 21.5" VESA

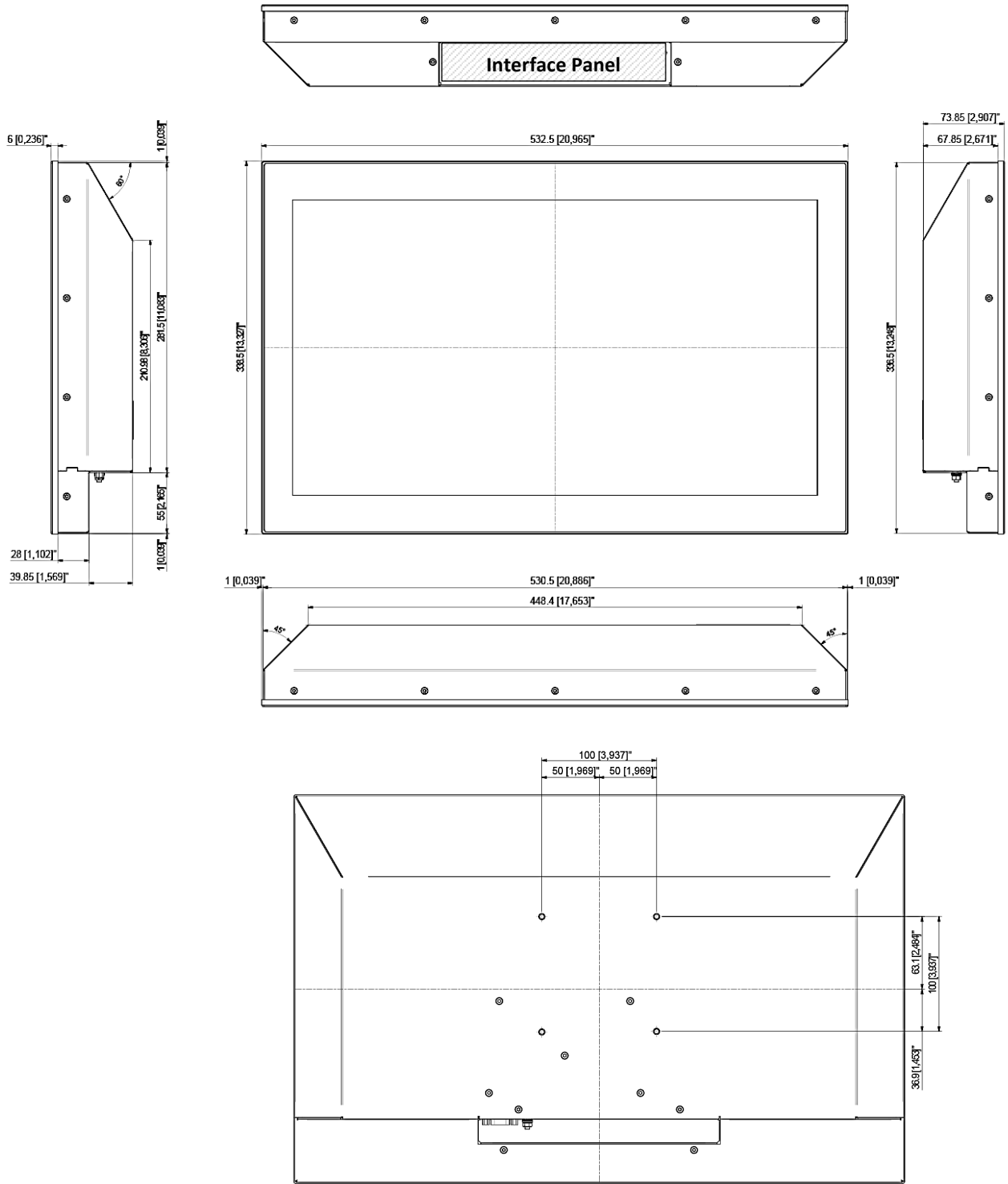

For the mechanical drawings and 3D Files, visit Kontron's [Customer Section](#).

### 8.11. 23.8" Panel Mount

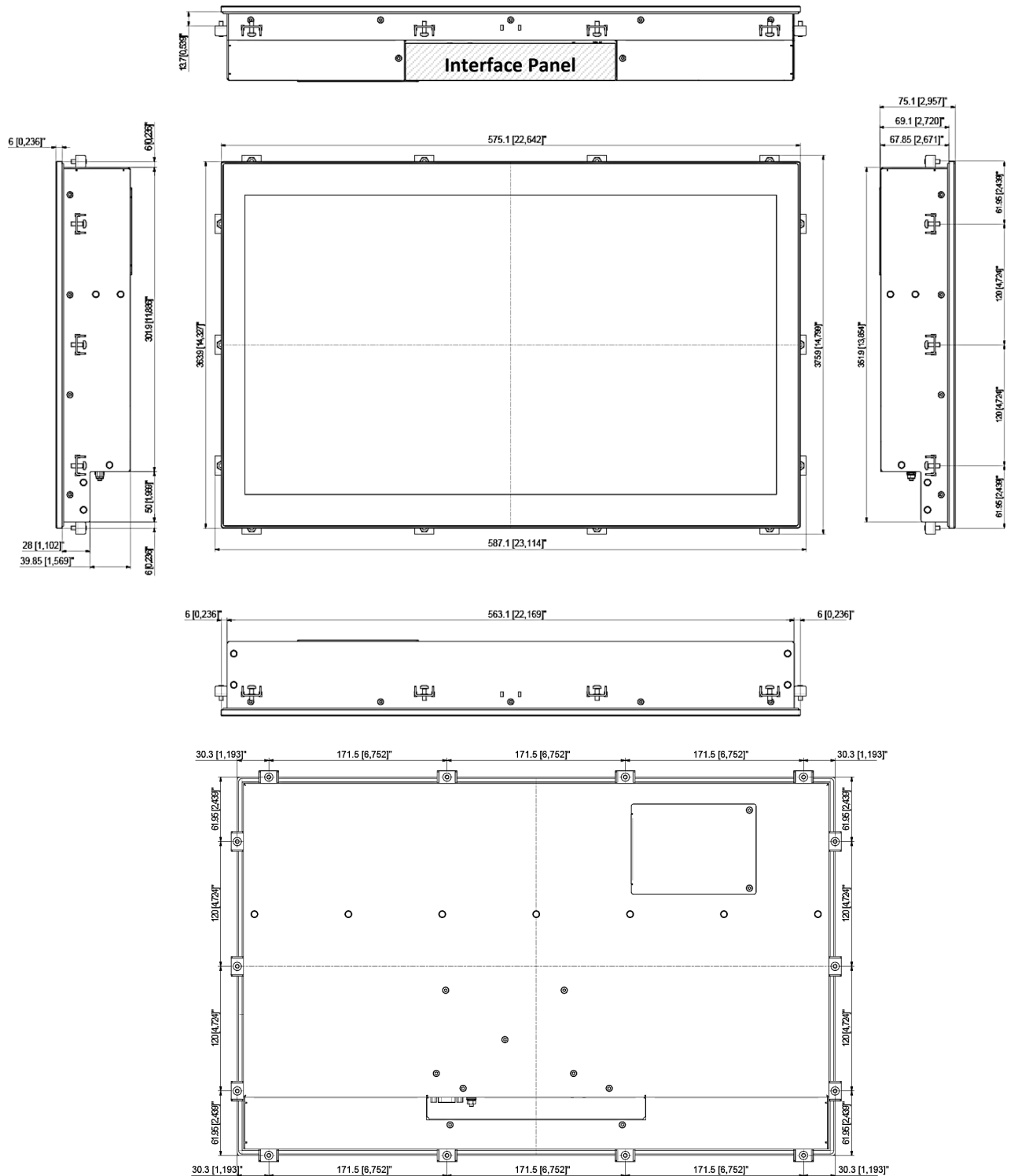

Dimensions	Panel Cutout Horizontal	Panel Cutout Vertical	Height for Mounting Brackets (max.)
23.8" Display	565.1 mm [22.248"]	353.9 mm [13.933"]	10.75 mm [0.423"]

## 8.12. 23.8" VESA

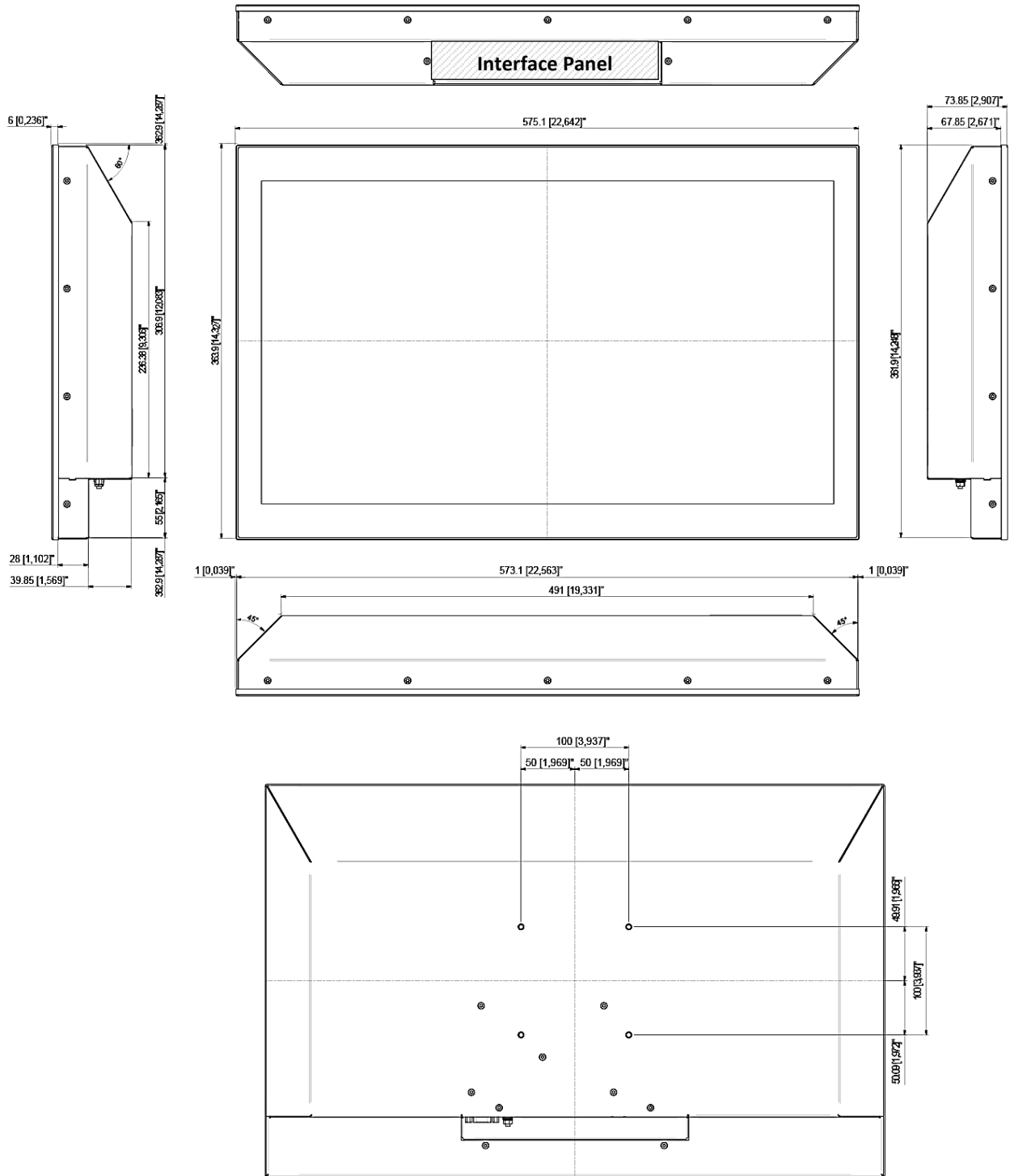

For the mechanical drawings and 3D Files, visit Kontron's [Customer Section](#).

## 9/Installation

Before installing the FlatClient PRO RPL in the operating environment, ensure that the operating environment meets the specification stated within this user guide, and that there is sufficient access to the Power IN connector (X101).

The product is designed for vertical operation (+/-25°) and intended for indoor use only without exposure to direct sunlight (UV radiation).

### ⚠ CAUTION

#### Do Not Mount Alone

Due to the weight of the product, mounting alone may result in product damage or personal injury.

### NOTICE

#### Proper Operation

User must ensure the following:

- › Mount the product in the vertical position +25°
- › Observe a suitable clearance distance all around the product
- › Provide sufficient ventilation
- › Ensure no other devices heat up the product

### NOTICE

#### Indoor Use Only

The product is intended for indoor use only. To avoid product damage do not use the product in a sheltered outdoor, outdoor or sunlit environment.

Observe that the product is not exposed to direct sunlight (UV radiation):

- › Prolonged exposure shortens field life and invalidates the warranty
- › Short exposure may lead to higher temperatures inside the product and cause permanent damage
- › Direct exposure accelerates long-term aging

For intend use in an outdoor environment or a sunlit environment, contact your Kontron sales representative.

### NOTICE

#### Handle Carefully

Handle with care to avoid damage to the front display screen.

### 9.1. Mounting Instructions - Panel Mount

To mount the FlatClient (panel mount variant) in a panel, follow the steps below:

1. Create the cutout required to mount the FlatClient in the panel by referring to the panel cutout dimensions for the corresponding display size in Chapter 8/: Mechanical Specification.
2. Make sure the panel mounting surface is clean, smooth and meets the thickness requirements of 3 mm to 7 mm.
3. Use all the clamping brackets and screws provided in the Mounting Set (see Figure 11). The number of clamping brackets and screws depends on the display size, see Table 2: List of Accessories.

**Figure 11: Mounting Set with Clamping Brackets and Screws**

4. Insert the screw into the clamping bracket (see Figure 12).

**Figure 12: Clamping Bracket with Screw**

5. Insert the clamping bracket in the housing (see Figure 13).

**Figure 13: Clamping Bracket Insertion**

6. Fasten the screw, to mount (see Figure 14). The recommended tightening torque is 0.8 Nm  $\pm$ 0.2 Nm. Use the correct screwdriver to fasten the M4x12 Torx screws.

**NOTICE****Do not use Force**

Do not use force when fastening the screw. Too much force may cause damage. The recommended torque to fasten the screws is 0.8 Nm  $\pm$ 0.2 Nm.

**Figure 14: Fastening the Clamping Bracket**

7. Repeat step 4 for all delivered clamping brackets (see Figure 15).

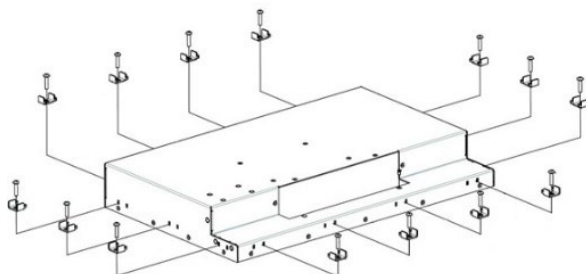
**Figure 15: Clamping Bracket Positions**

**Verify Secure Mounting:****CAUTION**

- Always use all the clamping brackets and screws in the delivered Mounting Set
- Mount on a mounting surface 3 mm to 7 mm thick



The number of clamping brackets depends on the size of the display. For more information, see Table 7: Display Specification.

## 9.2. Mounting Instructions - VESA

To mount the FlatClient (VESA variant) on a VESA stand or pole, follow the steps below:

1. Selecting a VESA mounting bracket that corresponds to the VESA requirement VESA (75 mm or 100 mm).
2. Mount using all four threaded openings and M4 screws that are long enough to secure the product. The required screw length depends on the VESA bracket's thickness. However, to avoid damaging the product, the screws provided by the user must not exceed the specified maximum penetration length 8 mm (0.31 inch).

**NOTICE****Screw length**

Mount using all four threaded holes with screws long enough to secure the product. Do not use screws longer than 8 mm (0.31 inch).



The VESA (75/100) mount option are for:

- VESA 75 mm for display size 10.1" and 12.1"
- VESA 100 mm for display sizes 15.6", 18.6", 21.5" and 23.8"

## 10/ Starting Up

Before connecting the FlatClient PRO RPL to power, read the instruction in this user guide and observe the safety instructions in Chapter 2/: General Safety Instructions.

The product comes hardware configured and on request with a pre-installed Operating System (OS) and all the necessary drivers. Enabling full operation when connected to power and switched on for the first time.

The product boots automatically when connected to power and restarts automatically when power returns after an interruption.

---

### External Power Supply

**CAUTION**

Only connect the product to an external power supply providing the voltage type (AC or DC) and the Power IN (max. current) specified on the Kontron Product Label.

The external power supply must meet the requirements of ES1/PS2 according to IEC/UL 62368-1.

---

### Switch off Properly

**CAUTION**

Switching off the product using the power button does not disconnect the product from the mains power source. Complete disconnection is only possible by removing the power cable from the Power IN connector (X101) or the mains power supply plug.

---

**CAUTION**

### Visible Damage

Do not switch on or handle the product if there is any visible damage.

---

**NOTICE**

### Mark the Power Supply Wires

Mark the supply wires (+/-) clearly to ensure a safe connection from the power connector to the DC power supply.

---

**NOTICE**

### Protection

To protect the product and any connected peripherals, make sure that the power cables have the right diameter to withstand the maximum available current.

---

**NOTICE**

### Support Cables

Support the power and I/O cables to minimize the strain on the connectors.

---

**NOTICE**

### Proper Cabling Procedure

The last cable to be connected must always be the power cable.

---



For essential drivers, visit Kontron's [Customer Section](#) website.

---

## 10.1. Connecting to the AC/DC Power Supply

To connect the FlatClient to the delivered AC/DC power supply with power connector, perform the following:

1. Connect the ground to the functional earth bolt if not already connected.
2. Connect the power supply to the Power IN connector (Figure 6, pos. 1) using the Phoenix connector. Pay attention to the polarity of the connections
3. Connect the power cord for your region to the AC/DC power supply and then to the mains power source.
4. The FlatClient boots automatically when connected to power and the STAT LED illuminates green and the PWR LED illuminates yellow.

## 10.2. Connecting to an External 24 VDC Power Supply

To connect the FlatClient to an external 24 VDC power supply, perform the following:

1. Connect the ground to the functional earth bolt if not already connected.
2. Wire the mating power connector with an appropriate wired power cabled as described in Chapter 10.2.1: Wiring the Mating Power Connector.
3. Switch off the external 24 VDC power supply via a disconnecting device (fuse/circuit breaker), to ensure that no power flows during the connection procedure.
4. Connect the wired mating power connector to the Power IN connector on the interface panel. Pay attention to the polarity of the connections.
5. Connect the other end of the wired mating power connector cable to the external 24 VDC power supply and switch on the external 24 VDC power supply.
6. The FlatClient boots automatically when connected to power and the STAT LED illuminates green and the PWR LED illuminates yellow.

### 10.2.1. Wiring the Mating Power Connector

When wiring the mating power connector, mark the supply wires (+/-) clearly to ensure a safe connection from the power connector to the DC power supply.

**Figure 16: Mating Power Connector**

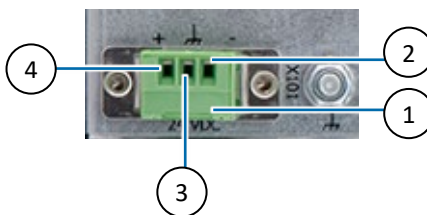

- |  |                        |
|--|------------------------|
| 1 Cover over the slotted pan head screws | 3 Not Connected (NC)   |
| 2 Clamp for 0 VDC wire                   | 4 Clamp for + VDC wire |

To wire the supplied mating power connector, perform the following:

1. Cut three (1 mm<sup>2</sup>) AWG18 isolated wires to the required length and strip each end 5 mm to 7 mm.
2. Twist the striped wire-ends and provide them with ferrules.
3. Access the slotted pan head screws by opening the mating power connector's cover (Figure 16, pos. 1).

4. Loosen the slotted pan head screws far enough so that you can insert the end of the prepared wires.
5. Insert the wires into the corresponding clamp of the mating power connector. Pay attention to the polarity of the connections.
6. Fasten the screws to secure the wires into the mating power connector's clamps.
7. Close the mating power connector's cover (Figure 16, pos. 1).

### 10.3. Switching On/Off

Once connected to power, the product may be switched on and switched off using the power button on the rear panel. Switching off using the power button performs an orderly system shutdown but does not fully disconnect the product from the mains power source. To ensure the product is fully disconnected, remove the power cable from the product's Power IN connector (X101) or the mains power supply plug. Ensure that there is free and easy access to the power cable, to enable disconnection of the power cable.

---

#### Switch off Properly

##### **CAUTION**

Switching off the product using the power button does not disconnect the product from the mains power source. Complete disconnection is only possible by removing the power cable from the Power IN connector (X101) or the mains power supply plug.

---

#### Avoid Forced Shutdown

##### **NOTICE**

Do not disconnect the power while the product is operating. This performs a forced shutdown and can lead to loss of data. To shutdown properly without data loss, switch off using the power button.

---

# 11/ Connector Pin Assignments

## 11.1. Power IN Connector (X101)

**Table 19: Power IN Connector Pin Assignment**

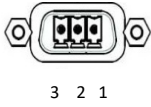
3-Pin Phoenix PSC 1.5/3-M	Pin	Signal Name/ Description
	1	GND (-)
	2	Connected to system chassis (electrical connected to functional earth bolt)
	3	VCC (+)
<b>Mating Connector</b>		3-pin Phoenix PSC 1.5/ 3-F

### Include a Functional Earth

#### ⚠ CAUTION

There is no isolation between Power IN GND and the system chassis, include a functional earth.

## 11.2. Ethernet 2.5 GbE Ports (X102, X103)

**Table 20: Ethernet 2.5 GbE Port Pin Assignment (X102, X103)**

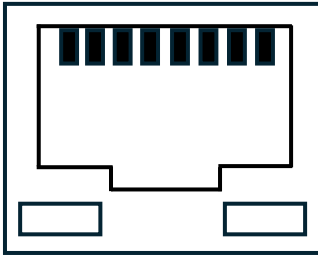
RJ45 (female)	Pin	Signal Name
	1	TX1+
	2	TX1-
	3	TX2+
	4	TX3+
	5	TX3-
	6	TX2-
	7	TX4+
	8	TX4-

LED: Speed		LED: Link Activity	
Off	10 Mbps	Off	Link down
Orange	1000 Mbps	Yellow Flashing	Link up and active
Green	2500 Mbps	Yellow	Link up and no activity

Signal	Description
TX1+ / TX1-	In MDI mode, this is the first pair in 2.5GBase-T and 1000Base-T, i.e. the BI_DA+/- pair, and is the transmit pair in 10Base-T and 100Base-TX. In MDI crossover mode, this pair acts as the BI_DB+/- pair, and is the receive pair in 10Base-T and 100Base-TX.
TX2+ / TX2-	In MDI mode, this is the second pair in 2.5GBase-T and 1000Base-T, i.e. the BI_DB+/- pair, and is the receive pair in 10Base-T and 100Base-TX. In MDI crossover mode, this pair acts as the BI_DA+/- pair, and is the transmit pair in 10Base-T and 100Base-TX.
TX3+ / TX3-	In MDI mode, this is the third pair in 2.5GBase-T and 1000Base-T, i.e. the BI_DC+/- pair. In MDI crossover mode, this pair acts as the BI_DD+/- pair.

Signal	Description
TX4+ / TX4-	In MDI mode, this is the fourth pair in 2.5GBase-T and 1000Base-T, i.e. the BI_DD+/- pair. In MDI crossover mode, this pair acts as the BI_DC+/- pair.



To achieve the specified performance, Category 5 twisted pair cables must be used with 10/100 MByte and Category 5E, 6 or 6E with 1 GbE/2.5 GbE Ethernet networks.



Connected only to internal Ethernet networks located within the facility and not classified as TNV circuits.

### 11.3. USB 3.2 Gen 2 Connectors (X104, X105, X106, X107)

The four USB ports connectors support USB 3.2 Gen 2 compatible devices.



USB 3.2 Gen 2 ports are backwards compatible with earlier USB 3.0 versions and USB 2.0.

**Table 21: USB 3.2 Gen 2 Type A Pin Assignment (X104, X105, X106, X107)**

USB 3.2 Gen 2 Type A	Pin	Signal Name	Description
	1	USB VCC (+)	+5 V power supply for USB device
	2	USB_D-	USB 2.0 differential pair (-)
	3	USB_D+	USB 2.0 differential pair (+)
	4	GND	Ground
	5	USB_RX-	USB 3.2 receiver differential pair (-)
	6	USB_RX+	USB 3.2 receiver differential pair (+)
	7	GND	Ground
	8	USB_TX-	USB 3.2 transmitter differential pair (-)
	9	USB_TX+	USB 3.2 transmitter differential pair (+)



For USB 3.2 Gen 2 cabling, use only HiSpeed USB cable specified in the USB 3.2 Gen 2 standard.

## 11.4. Display Port Connectors (X108, X109)

The two Display Port (DP) connectors are standard DP ports.

**Table 22: Display Port Pin Assignment (X108, X109)**

20-pin Standard DP Connector (female)	Pin	Signal Name	Pin	Signal Name
	1	ML_Lane0+	11	GND
	2	GND	12	ML_Lane3-
	3	ML_Lane0-	13	Config1
	4	ML_Lane1+	14	Config2
	5	GND	15	AUX_CH+
	6	ML_Lane1-	16	GND
	7	ML_Lane2+	17	AUX_CH-
	8	GND	18	Hot_Plug
	9	ML_Lane2-	19	GND
	10	ML_Lane3+	20	DP_PWR

Signal Name	Description
ML_Lane# +/-	DisplayPort Lane # transmitter differential pair (+/-)
Aux +/-	DisplayPort Auxiliary channel differential pair (+)
HPD	Display Port hot plug detect
Config#	Connect to Ground directly or via a pulldown device
GND	Ground signal
PWR	Power supply signal for connector



Display port ++ supports the use of passive adapters to connect to HDMI or DVI.

## 11.5. Breakout Panel (option)

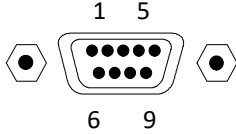

### 11.5.1. Serial Port (COM) Connector (X110, X111)

Table 23: Serial Port (RS232) Pin Assignment

9-pin D-SUB (male)	Pin	RS232	Description
	1	NC	-
	2	RxD	Received Data, receives data from the link.
	3	TxD	Transmitted Data, sends data to the link.
	4	NC	-
	5	GND	Ground signal
	6	NC	-
	7	NC	-
	8	NC	-
	9	NC	-

### 11.5.2. Wi-Fi/BT® Antenna (X110, X111)

Table 24: Wi-Fi/BT® Antenna Pin Assignment

Antenna Connector	Antenna Description
Wi-Fi/BT®  RP-SMA (female) with center pin and outer thread.	Wi-Fi Antenna  RP-SMA (male) antenna with pin socket and inner thread. 

#### Antenna RF exposure

Avoid RF antenna exposure by:

#### ⚠ CAUTION

- Avoid placing the antenna near people, minimum distance 20 cm.
- Avoid pointing the antenna at people.
- Keep a safe distance from the antenna especially when transmitting.

#### NOTICE

#### RP-SMA and SMA Antenna are not Interchangeable!

RP-SMA and SMA connectors and antenna are not electrically compatible. Incorrect connection may result in an insufficient connection or destroy the center pin.



Users are responsible for connecting the correct antenna type to the product's antenna connectors. Kontron recommends using Kontron's Wi-Fi/BT® reference antenna (RP-SMA male), included in the delivery, and chosen to meet RF performance requirements and supporting a nominal impedance of 50 ohms.

## 11.6. Internal Headers

This chapter describes internal headers accessible to the user through the service flap on the rear panel.

### 11.6.1. Automotive Battery Header

**Table 25: Automotive Battery Header Pin Assignment**

9-pin D-SUB (male)	Pin	Signal	Description
	1	+VRTC	RTC Battery VCC input voltage (red)
	2	GND	RTC Battery Ground (black)

#### Polarity

#### ⚠ CAUTION

When connecting the RTC Battery cable to the RTC battery header pay attention to the polarity of the connection.

## 12/ BIOS

The FlatClient PRO RPL uses the AMI Aptio V uEFI BIOS based on the Unified Extensible Firmware Interface (uEFI) specification and the Intel® Platform Innovation Framework for EFI. The uEFI BIOS preferences are preset and do not require further adjustment for operation.

The UEFI BIOS Setup menus and available selections are open to change. For specific information on the BIOS for your product, visit Kontron's [Customer Section](#), and access the FlatClient PRO RPL information.



UEFI only! No legacy support and no Master Boot Record (MBR) installation.



For the latest uEFI BIOS Information, visit Kontron's [Customer Section](#) to download the BIOS. If the information you require is not available within the Customer Section, contact [Kontron Support](#).

### 12.1. Starting the uEFI BIOS

The uEFI BIOS's Setup program provides quick and easy access to the individual function settings for control or modification of the uEFI BIOS configuration

Use the navigation hot keys, to navigate the BIOS. The hot key legend bar is located at the bottom right of each Setup screen. For a list of navigation hot keys, see Table 26: Navigation Hot Keys.

**Table 26: Navigation Hot Keys**

Sub-screen	Description
<F1>	<F1> key invokes the General Help window
<->	<Minus> key selects the next lower value within a field
<+>	<Plus> key selects the next higher value within a field
<F2>	<F2> key loads previous values
<F3>	<F3> key loads optimized defaults
<F4>	<F4> key Saves and Exits
<←> or <→>	<Left/Right> arrows select major Setup menus on menu bar, for example, Main or Advanced
<↑> or <↓>	<Up/Down> arrows select fields in the current menu, for example, Setup function or sub-screen
<ESC>	<ESC> key exits a major Setup menu and enters the Exit Setup menu Pressing the <ESC> key in a sub-menu displays the next higher menu level
<RETURN>	<RETURN> key executes a command or selects a submenu

To start the uEFI BIOS Setup program, follow the steps below:

1. Switch on the product.
2. Wait until the first characters appear on the screen (POST messages or splash screen).
3. Press the <DEL> key.
4. If the uEFI BIOS is password-protected, a request for password will appear. Enter either the User Password or the Supervisor Password, press <RETURN>, and proceed with step 5.
5. The BIOS setup utility appears in the Main menu.

6. Use the Navigation Hot Keys arrow keys to navigate to the required Setup menu to “change,” or “reset,” settings.
7. Navigate using Navigation Hot Key arrow keys to the “Save & Exit” Setup menu and select “Save Changes”.

## 12.2. BIOS Update

To ensure compatibility with new OS, hardware, software or to integrate new BIOS functions Kontron recommends performing regular BIOS updates. Additionally, if a problem cannot be solved using a new driver, Kontron recommends updating the BIOS.

For the latest BIOS downloads and release information, visit Kontron’s [Customer Section](#). Select the latest version of the BIOS Update and the preferred method to update the BIOS with instructions.



To discover your current BIOS version, refer to the Kontron BIOS Version number within the Main menu.

## 12.3. Setup Menus

The Setup menus listed in the selection bar at the top of the screen are:

- › Main
- › Advanced
- › Chipset
- › Security
- › Boot
- › Save & Exit

The current active menu and active BIOS Setup item are highlighted in white. Use the left and right arrow keys to select the Setup menus.

Each Setup menu is made up of two main frames. The left frame displays all available functions. Configurable functions are displayed in blue. Functions displayed in grey provide information about the status or the operational configuration. The right frame displays an explanation of the respective function in a help window.

### Advanced Setup Menu – Caution when Changing

#### NOTICE

Making changes within the Advanced Setup menu without understanding the full implications may cause system malfunction.

Kontron recommends users to make changes only when the user is sure of the impact.



Functions displayed in “grey” in the following setup menus and tables provide information about the status or the operational configuration of the product but are not selectable and not changeable.

## 12.4. Main Setup Menu

The Main Setup menu provides basic system information and functions for setting the system time and date.

Figure 17: Main Setup Menu Example

Aptio Setup - AMI					
Main	Advanced	Chipset	Security	Boot	Save & Exit
<b>Product Information</b>					
Product Name		3.5-SBC-RPL			
<b>BIOS Information</b>					
BIOS Vendor		American Megatrends			
Core Version		5.32			
Compliance		UEFI 2.9 ; PI 1.7			
Kontron BIOS Version (FLATCRPL100)		RPLUVEXR.140 (x64)			
Access Level		Administrartor			
<b>FPS Information</b>					
FSP version		0C.01.DE.40			
RC version		0C.00.DE.40			
Build Date					
FSP Mode		Dispatch Mode			
<b>Processor Information</b>					
Name		RaptorLake ULT			
Type		13 <sup>th</sup> Gen Intel® Core™ i3-1315UE			
Speed		1200 MHz			
ID		0xB06A3			
Stepping		Q0			
Package		Not Implemented Yet			
Number of Efficient-cores		4Core(s) / 4Thread(s)			
Microcode Revision		4121			
GT Info		0xA7A9			
IGFX GOP Version		21.0.1065			
Memory RC Version		0.0.4.224			
Total Memory		16384 MB			
Memory Frequency		5200 MHz			
<b>PCH Information</b>					
Name		PCH-P			
PCH SKU		RPL-P: Premium			
Stepping		A1			
ChipsetInit Base Revision		2			

Aptio Setup - AMI					
Main	Advanced	Chipset	Security	Boot	Save & Exit
ChipsetInit OEM Revision		0			
Package		Not Implemented Yet			
TXT Capability of Plattform/PCH		Unsupported			
Production Type		Production			
Dual Output Fast Read support		Supported			
Read ID/Status Clock Freq		50 MHz			
Write and Erase Clock Freq		50 MHz			
Fast Read Clock Freq		50 MHz			
Fast Read support		Supported			
Number of Components		1 Component			
SPI Component 0 Density		32 MB			
eSPI Flash Sharing Mode		G3			
EC PECI Mode		Legacy PECI mode			
ME FW Version		16.1.30.2307			
ME Firmware SKU		Consumer SKU			
PMC FW Version		160.1.0.1030			
<b>System Language</b>		[English]			
<b>► Platform Information</b>					
Board Information					
Product Name		3.5-SBC-RPL			
Serial#		XXXXXXXX			
UUID		XXXXXXXX-XXXX-XXXX-XXXX-XXXXXXXXXXXX			
<b>KSC Information</b>					
Controller		KSC Main Controller			
Operating Mode		Normal			
Board Name		3.5-RPL			
Platform ID		000C			
KSC Spec. Version		1.20			
BIOS Protocol Version		2.3.1			
BIOS SW Spec. Version		1.18			→ ←: Select Screen
Core Firmware Version		1.4.1 Release			↑ ↓: Select Item
Board Firmware Version		1.1.0 Release			Enter: Select
SCM Info		30-F4-D1-45			+/-: Change Opt.
Boot counter		N/A			F2: Previous Values
					F3: Optimized Defaults
System Date		xxx xx/xx/xxxx			F4: Save & Reset
System Time		xx:xx:xx			ESC: Exit

## 12.5. Advanced Setup Menu

Figure 18: Advanced Setup Menu Example

Aptio Setup - AMI					
Main	Advanced	Chipset	Security	Boot	Save & Exit
Configurable TDP Mode			[Nominal]		
In-Band ECC Support			[Disabled]		
Compliance Test Mode			[Disabled]		
HD Audio			[Enabled]		
Power Mode Selection			AT Mode		
Resore AC Power Loss			Power Off		
Power Saving Mode			[Disabled]		
ME FW Image Re-Flash			[Disabled]		
Unconfigure ME			[Disabled]		
AMT BIOS Feature			[Disabled]		
▶ Display Configuration					
▶ Trusted Computing					
▶ ACPI Settings					
▶ Miscellaneous					
▶ MEBx					
▶ H/W Monitor					
▶ S5 RTC Wake Settings					
▶ Serial Port Console Redirection					
▶ SIO Configuration					
▶ USB Configuration					
▶ Network Stack Configuration					
▶ NVME Configuration					
▶ CH7513A Configuration					
▶ F81435 Configurations					
▶ Intel® Ethernet Controller I226-LM – XX:XX:XX:XX:XX:XX					
▶ Intel® Ethernet Controller I226LM – XX:XX:XX:XX:XX:XX					
▶ Driver Health					
				→ ←: Select Screen	
				↑ ↓: Select Item	
				Enter: Select	
				+/-: Change Opt.	
				F1: General Help	
				F2: Previous Values	
				F3: Optimized Defaults	
				F4: Save & Reset	
				ESC: Exit	

**Table 27: Advanced Setup Menu Sub-screens**

Sub-screen	BIOS Default	Possible Settings
Configurable TDP Boot Mode	Nominal	Nominal, Low Level, High Level
In-Band ECC Support	Disabled	Disabled, Enabled
Compliance Test Mode	Disabled	Disabled, Enabled
HD Audio	Enabled	Disabled, Enabled
Power Mode Selection	ATX Mode	
Resore AC Power Loss	Power Off	Power Off, Last State
Power Saving Mode	Disabled	Disabled, Enabled
ME FW Image Re-Flash	Disabled	Disabled, Enabled
Unconfigure ME	Disabled	Disabled, Enabled
AMT BIOS Features	Disabled	Disabled, Enabled

**Display Configuration**

Sub-screen	BIOS Default	Possible Settings
Display Configuration		
VBT Select	DP	DP, HDMI
Primary Display	IGFX	Auto, IGFX, PEG Slot; PCH PCI
Internal Graphics	Enabled	
Aperture Size	256MB	128MB, 256MB, 512MB, 1024MB

**Trusted Computing**

Sub-screen	BIOS Default	Possible Settings
TPM 2.0 Device Found		
Firmware Version	16.13	
Vendor	IFX	
Security Device Support	Enable	Disabled, Enable
Active PCR banks	SHA256	
Available PCR banks	SHA256,SHA384	
SHA256 PCR Bank	Enabled	Disabled, Enabled
SHA384 PCR Bank	Disabled	Disabled, Enabled
Pending Operation	None	None, TPM Clear
Platform Hierarchy	Enabled	Disabled, Enabled

Sub-screen	BIOS Default	Possible Settings
Storage Hierarchy	Enabled	Disabled, Enabled
Endorsement Hierarchy	Enabled	Disabled, Enabled
Physical Presence Spec Version	1.3	1.2, 1.3
TPM 2.0 InterfaceType	TIS	
Device Select	Auto	TPM 1.2, TPM 2.0, Auto

### ACPI Settings

Sub-screen	BIOS Default	Possible Settings
ACPI Settings		
Enable ACPI Auto Configuration	Disabled	Disabled, Enabled
Enable Hibernation	Enabled	Disabled, Enabled
ACPI Sleep State	S3 (Suspend to RAM)	Suspend Disabled, S3 (Suspend to RAM)

### Miscellaneous

Sub-screen	BIOS Default	Possible Settings
Miscellaneous Configuration		
▶ Present DIO in BIOS		
GPIO OS usable	GPIO 0 – GPIO 7	All available GPIO, GPIO 0 – GPIO 7
Control DIO in BIOS	Disabled	Disabled, Enabled
▶ Control KSC firmware		
Lock FW update access	Enabled	Disabled, Enabled
▶ KSC OTP area control		
KSC OTP access lock	Enabled	Disabled, Enabled
▶ Update KSC firmware		
Auto update KSC FW	Enabled	Disabled, Enabled
▶ Generic eSPI Decode Rangers		
Generic LPC via eSPI Decode 1	Disabled	Disabled, Enabled
▶ Watchdog		
Auto-reload	Disabled	Disabled, Enabled
Global Lock	Disabled	Disabled, Enabled
WDT Strobe	Disabled	Disabled, Enabled
Stage 1 Mode	Disabled	Disabled, Reset, Delay, WDT Signal only
Reset Button Behavior	Disabled	Chipset Reset, Power Cycle

Sub-screen	BIOS Default	Possible Settings
I2C Speed	100 KHz	100 KHz, 400 KHz, 1 MHz
On-board I2C Mode	Multimaster	Multimaster, Busclear
Manufacturing Mode	Disabled	
BIOS Test Mode	Disabled	
Last system reset through	Power-on reset	
PCIe Wake	Enabled	Disabled, Enabled
On-board EEPROM Write Protect	WP Enabled	WP Disabled, WP Enabled

## MEBX

Sub-screen	BIOS Default	Possible Settings
Intel® ME Password <sup>[1]</sup>		

<sup>[1]</sup> Submenu is only accessible when “AMT BIOS Features” is enable

## H/W Monitor

Sub-screen	BIOS Default	Possible Settings
KSC based H/W Monitor		
Temperature sensors:		
#1: CPU Temp	x xxx.x C	
#2: PCH Temp	x xxx.x C	
#3: System Temp	x xxx.x C	
Voltage sensors:		
#1: V_IN	xx.x V	
#1: 12V_S0	xx.x V	
#1: 5V_S0	xx.x V	
#1: 3V3_S0	xx.x V	
#1: 3V_BAT	xx.x V	
Fan speed & control:		
#1: CPU FAN	x RPM	
Fan Control	Auto	Disabled, Manual, Auto
Signal Filter Control	Auto	Disabled, Manual, Auto
Signal Filer	Enabled	
Fan Pulse	Auto	Auto, 1, 2, 3, 4, 5, 6, 7, 8

Sub-screen	BIOS Default	Possible Settings
Fan Pulse	2	
Fan Speed Control	Auto	Auto, 1, 2, 3, 4, 5, 6, 7, 8
Fan Speed Control	Normal	
Reference Temperature	All Temperatures	#1: CPU Temp, #2: PCH Temp, #3: System Temp, All Temperatures
▶ Fan Trip Point Table		
Fan 1 Automode	Internal table	Internal table, User table

### S5 RTC Wake Settings

Sub-screen	BIOS Default	Possible Settings
Wake system from S5	Disabled	Disabled, Fixed Time, Dynamic Time

### Serial Port Console Redirection (COM0, COM1, EMS)

Sub-screen	BIOS Default	Possible Settings
COM0		
Console Redirection	Disabled	Disabled, Enabled
▶ Console Redirection Settings		
Terminal Type	ANSI	VT100, VT100Plus, VT-UTF8, ANSI
Bits per second	115200	9600, 19200, 38400, 57600, 115200
Data Bits	8	7, 8
Parity	None	None, Even, Odd, Mark, Space
Stop Bits	1	1, 2
Flow Control	None	None, Hardware RTS/CTS
CT-UTF8 Combo Key Support	Enabled	Disabled, Enabled
Recorder Mode	Disabled	Disabled, Enabled
Resolution 100x31	Disabled	Disabled, Enabled
Putty KeyPad	VT100	VT100, LINUX, XTERMR6, SCO, ESCN, VT400
COM1		
Console Redirection	Disabled	Disabled, Enabled
▶ Console Redirection Settings		
Terminal Type	ANSI	VT100, VT100Plus, VT-UTF8, ANSI
Bits per second	115200	9600, 19200, 38400, 57600, 115200
Data Bits	8	7, 8

Sub-screen	BIOS Default	Possible Settings
Parity	None	None, Even, Odd, Mark, Space
Stop Bits	1	1, 2
Flow Control	None	None, Hardware RTS/CTS
CT-UTF8 Combo Key Support	Enabled	Disabled, Enabled
Recorder Mode	Disabled	Disabled, Enabled
Resolution 100x31	Disabled	Disabled, Enabled
Putty KeyPad	VT100	VT100, LINUX, XTERMR6, SCO, ESCN, VT400
Legacy Control Redirection		
▶ Legacy Console Redirection Settings		
Serial Port for Out-of-Band Management / Windows Emergency Management Services (EMS)		
Console Redirection EMS	Disabled	Disabled, Enabled
▶ Console Redirection Settings		
Out-of-Band Mgmt Port	COM0	COM0 COM1
Terminal Type EMS	VT-UTF8	VT100, VT100Plus, VT-UTF8, ANSI
Bits per second EMS	115200	9600, 19200, 57600, 115200
Flow Control EMS	None	None, Hardware RTS/CTS
Data Bits EMS	8	
Parity EMS	None	
Stop Bits EMS	1	

### SIO Configuration (Serial Port 0, Serial Port 1)

Sub-screen	BIOS Default	Possible Settings
AMI SIO Driver Version: A5.19.00		
WARNING: Logical Device state on the left side of the control reflects the current Logical Device state. Changes made during Setup Session will be shown after you restart the system.		
Super IO Chip Logical Device(s) Configuration		
▶ [*Active*] Serial Port 0		
Serial Port 0 Configuration		
Use This Device	Enabled	Disabled, Enabled
Logical Device Settings:		

Sub-screen	BIOS Default	Possible Settings
Current: IO=3F8h; IRQ=4;		
Possible:	Use Automatic Settings	Use Automatic Settings IO=3F8h; IRQ=4; IO=3F8h; IRQ=4; IO=2F8h; IRQ=3
Warning: Disabling SIO Logical Device may have unwanted side effects. PROCEED WITH CAUTION.		
▶ [*Active*] Serial Port 1		
Serial Port 1 Configuration		
Use This Device	Enabled	Disabled, Enabled
Logical Device Settings:		
Current: IO=2F8h; IRQ=3;		
Possible:	Use Automatic Settings	Use Automatic Settings IO=2F8h; IRQ=3; IO=2F8h; IRQ=3; IO=3F8h; IRQ=4
Warning: Disabling SIO Logical Device may have unwanted side effects. PROCEED WITH CAUTION.		

## USB Configuration

Sub-screen	BIOS Default	Possible Settings
USB configuration		
USB Module Version 34		
USB Controllers:		
2 XHCIs		
USB Devices:		
xxxxxxx		
Legacy USB Support	Enabled	Disabled, Enabled, Auto
XHCI Hand-off	Disabled	Disabled, Enabled
USB Mass Storage Driver Support	Enabled	Disabled, Enabled

Sub-screen	BIOS Default	Possible Settings
USB hardware delays and time-outs:		
USB transfer time-out	20 sec	1 sec, 5 sec, 10 sec, 20 sec
Device reset time-out	20 sec	10 sec, 20 sec, 30 sec, 40 sec
Device power-up delay	Auto	Auto, Manuel

### Network Stack Configuration

Sub-screen	BIOS Default	Possible Settings
Network Stack	Disabled	Disabled, Enabled
IPv4 PXE Support	Disabled	Disabled, Enabled
IPv4 HTTP Support	Disabled	Disabled, Enabled
IPv6 PXE Support	Disabled	Disabled, Enabled
IPv6 HTTP Support	Disabled	Disabled, Enabled
PXE boot wait time	0	0-5
Media detect count	1	1-50

### NVME Configuration

Sub-screen	BIOS Default	Possible Settings
NVMe Configuration		
No NVME Device Found		

### CH7513A Configuration

Sub-screen	BIOS Default	Possible Settings
CH7513A Configuration (DP/eDP to LVDS Convertor)		
LFP Selection	LVS	Disabled, LVDS, eDP

### F81435 Configurations

Sub-screen	BIOS Default	Possible Settings
F81435 Configurations (Multiprotocol RS232/RS422/RS485 Transceiver)		
COM1 Mode Selection	RS232	RS422 Single Master, RS232, RS485 with Auto Flow Control, RS422 Multi Master

Sub-screen	BIOS Default	Possible Settings
COM1 Transceiver	Normal mode	Shut down mode, Normal mode
COM1 Internal Terminator Switch Control	Terminator switch is disabled.	Terminator switch is disabled. Terminator switch is enabled.
COM1 External Terminator Switch Control	Terminator switch is disabled.	Terminator switch is disabled. Terminator switch is enabled.
COM2 Mode Selection	RS232	RS422 Single Master, RS232, RS485 with Auto Flow Control, RS422 Multi Master
COM2 Transceiver	Normal mode	Shut down mode, Normal mode
COM2 Internal Terminator Switch Control	Terminator switch is disabled.	Terminator switch is disabled. Terminator switch is enabled.
COM2 External Terminator Switch Control	Terminator switch is disabled.	Terminator switch is disabled. Terminator switch is enabled.

### Intel Ethernet Controller

Sub-screen	BIOS Defaults	Possible Setting
Intel Ethernet Controller I226LM-XX:XX:XX:XX:XX		

### Intel Ethernet Controller

Sub-screen	BIOS Defaults	Possible Setting
Intel Ethernet Controller I226LM-XX:XX:XX:XX:XX		

### Drive Health

Sub-screen	BIOS Defaults	Possible Setting
▶ Intel® 2.5G Ethernet Controller 0.10.06 Healthy		
▶ Intel® Ethernet Controller 0.10.06 Healthy		
▶ Intel® 2.5G Ethernet Controller 0.10.06 Healthy		
▶ Intel® Ethernet Controller 0.10.06 Healthy		

## 12.6. ChipSet Setup Menu

Figure 19: Chipset Setup Menu

Aptio Setup - AMI					
Main	Advanced	Chipset	Security	Boot	Save & Exit
<ul style="list-style-type: none"> <li>▶ System Agent (SA) Configurations</li> <li>▶ PCH-IO Configuration</li> </ul>					
				→ ←: Select Screen ↑ ↓ : Select Item Enter: Select +/-: Change Opt. F1: General Help F2: Previous Values F3: Optimized Defaults F4: Save & Reset ESC: Exit F4: Save & Reset	

The following table gives more information about important setup options within the Chipset Menu.

Table 28: Chipset Setup Menu Sub-screens

### System Agent (SA) Configuration

Sub-screen	BIOS Defaults	Possible Setting
System Agent (SA) Configuration		
VT-D	Supported	
▶ Graphics Configuration		
Graphics Turbo IMON Current	31	14-31
Skip Scanning of External Gfx Card	Disabled	Disabled, Enabled
Select PCIE Card	Auto	Auto, Elk Creek 4, PEG Eval
HG Delay After Power Enable	300	300
HG Delay After Hold Reset	100	100
▶ External Gfx Card Primary Display Configuration		
External Gfx Card Primary Display Configuration		

Sub-screen	BIOS Defaults	Possible Setting
GTT Size	8MB	2MB, 4MB, 8MB
PSMI SUPPORT	Disabled	Disabled, Enabled
DVMT Total Gfx Mem	256M	128M, 256M, MAX
Igfx Gsm2	0GB	0GB, 2GB, 4GB, 6GB, 8GB, 10GB, 12GB, 14GB, 16GB, 18GB, 20GB, 22GB, 24GB, 26GB, 28GB, 30GB, 32GB
Intel Graphics Pei Display Peim	Disabled	Disabled, Enabled
VDD Enable	Enabled	Disabled, Enabled
Configure GT for use	Enabled	Disabled, Enabled
RC1p Support	Disabled	Disabled, Enabled
PAVP Enable	Enabled	Disabled, Enabled
Cdynmax Clamping Enable	Disabled	Disabled, Enabled
Cd Clock Frequency	Max CdClock freq based on Reference Clk	192 Mhz, 307.2 Mhz, 556.8 Mhz, 652.8 Mhz, Max CdClock freq based on Ref. Clk
Enable Display Audio Link in Pre-OS	Disabled	Disabled, Enabled
IUER Button Enable	Disabled	Disabled, Enabled
▶ LCD Control		
LCD Panel Type	VBIOS Default	VBIOS Default 640x480 LVDS 800x600 LVDS 1024x768 LVDS 1280x1024 LVDS 1400x1050 LVDS 1400x1050 LVDS 1600x1200 LVDS 1280x768 LVDS 1280x1050 LVDS 1680x1050 LVDS 1920x1200 LVDS 1600x900 LVDS 1280x800 LVDS 1280x600 LVDS 2048x1536 LVDS 1366x768 LVDS
Panel Scaling	Auto	Auto, Off, Force Scaling
Backlight Control	PWM Normal	PWM Inverted, PWM Normal
Active LFP	eDP Port-A	No eDP, eDP Port-A
Panel Color Depth	18 Bit	18 Bit, 24 Bit

Sub-screen	BIOS Defaults	Possible Setting
Backlight Brightness	255	255
▶ Intel® Ultrabook Event Support		
IUER Slate Enable	Disable	Disabled, Enabled
IUER Dock Enable	Disable	Disabled, Enabled
VT-d	Enabled	Disabled, Enabled
Above 4GB MMIO BIOS assignment	Enabled	Disabled, Enabled

## PCH-IO Configuration

Sub-screen	BIOS Defaults	Possible Setting
PCH-IO Configuration		
▶ PCI Express Configuration		
DMI Link ASPM Control	Auto	Disabled, L0s, L1, L0L1, Auto
Port8xh Decode	Disabled	Disabled, Enabled
PCIe function swap	Enabled	Disabled, Enabled
PCH PCIE Clock Gating	Disabled	Disabled, L0s, L1, L0L1, Auto
PCH PCIE Power Gating	Disabled	Disabled, L0s, L1, L0L1, Auto
▶ PCIe EQ settings		
PCIe EQ override	Disabled	Disabled, Enabled
PCI Express Root Port 1	Lane configured as USV/SATA/UFS	
PCI Express Root Port 2	Lane configured as USV/SATA/UFS	
PCI Express Root Port 3	Lane configured as USV/SATA/UFS	
PCI Express Root Port 4	Lane configured as USV/SATA/UFS	
▶ PCI Express Root Port 5		
PCI Express Root Port 5	Enabled	Disabled, Enabled
Connection Type	Slot	Built-in, Slot
ASPM	Auto	Disabled, L1, Auto
L1 Substates	L1.1 & L1.2	Disabled, L1.1, L1.1 & L1.2
L1 Low	Enabled	Disabled, Enabled
ACS	Enabled	Disabled, Enabled

Sub-screen	BIOS Defaults	Possible Setting
PTM	Enabled	Disabled, Enabled
DPC	Disabled	Disabled, Enabled
EDPC	Enabled	Disabled, Enabled
URR	Disabled	Disabled, Enabled
FER	Disabled	Disabled, Enabled
NFER	Disabled	Disabled, Enabled
CER	Disabled	Disabled, Enabled
SEFE	Disabled	Disabled, Enabled
SENF	Disabled	Disabled, Enabled
SECE	Disabled	Disabled, Enabled
PME SCI	Enabled	Disabled, Enabled
Hot Plug	Disabled	Disabled, Enabled
Advanced Error Reporting	Enabled	Disabled, Enabled
PCIe Speed	Auto	Auto, Gen1, Gen2, Gen3
Transmitter Half Swing	Disabled	Disabled, Enabled
Detect Timeout	0	0-65535
Extra Bus Reserved	0	0-7
Reserved Memory	10	1-20
Reserved I/O	4	4-20
PCH PCIe LTR Configuration		
LTR	Enabled	Disabled, Enabled
Snoop Latency Override	Auto	Disabled, Manual, Auto
Non Snoop Latency Override	Auto	Disabled, Manual, Auto
LTR Lock	Disabled	Disabled, Enabled
Peer Memory Write Enable	Disabled	Disabled, Enabled
PCI Express Root Port 6	Shadowed by x2/x4 port	
▶ PCI Express Root Port 7	(refer to PCI Express Port 5)	
▶ PCI Express Root Port 8	(refer to PCI Express Port 5)	
▶ PCI Express Root Port 9	(refer to PCI Express Port 5)	
▶ PCI Express Root Port 10	(refer to PCI Express Port 5)	
PCI Express Root Port 11	Lane configured as USV/SATA/UFS	
PCI Express Root Port 12	Lane configured as USV/SATA/UFS	

Sub-screen	BIOS Defaults	Possible Setting
▶ PCIe Clocks		
Clock0 assignment	Enabled	Platform-POR, Enabled, Disabled
ClkReq for Clock0	Platform-POR	Platform-POR, Disabled
Clock1 assignment	Enabled	Platform-POR, Enabled, Disabled
ClkReq for Clock1	Platform-POR	Platform-POR, Disabled
Clock2 assignment	Enabled	Platform-POR, Enabled, Disabled
ClkReq for Clock2	Platform-POR	Platform-POR, Disabled
Clock3 assignment	Enabled	Platform-POR, Enabled, Disabled
ClkReq for Clock3	Platform-POR	Platform-POR, Disabled
Clock4 assignment	Enabled	Platform-POR, Enabled, Disabled
ClkReq for Clock4	Platform-POR	Platform-POR, Disabled
Clock5 assignment	Enabled	Platform-POR, Enabled, Disabled
ClkReq for Clock5	Platform-POR	Platform-POR, Disabled
Clock6 assignment	Enabled	Platform-POR, Enabled, Disabled
ClkReq for Clock6	Platform-POR	Platform-POR, Disabled
Clock7 assignment	Enabled	Platform-POR, Enabled, Disabled
ClkReq for Clock7	Platform-POR	Platform-POR, Disabled
Clock8 assignment	Enabled	Platform-POR, Enabled, Disabled
ClkReq for Clock8	Platform-POR	Platform-POR, Disabled
Clock9 assignment	Enabled	Platform-POR, Enabled, Disabled
ClkReq for Clock9	Platform-POR	Platform-POR, Disabled
▶ SATA Configuration		
SATA Controller(s)	Enabled	Disabled, Enabled
SATA Mode Selection	AHCI	AHCI
SATA Test Mode	Disabled	Disabled, Enabled
Aggressive LPM Support	Enabled	Disabled, Enabled
Serial ATA Port 0	Empty	
Software Preserve	Unknown	
Port 0	Enabled	Disabled, Enabled
Hot Plug	Disabled	Disabled, Enabled
Configure as eSATA	Hot Plug supported	

Sub-screen	BIOS Defaults	Possible Setting
External	Disabled	Disabled, Enabled
Spin Up Device	Disabled	Disabled, Enabled
SATA Device Type	Hard Disk Drive	Hard Disk Drive, Solid State Drive
Topology	Unknown	Unknown, ISATA, Direct connect, Flex, M2
SATA Port 0 DevSlp	Disabled	Disabled, Enabled
DITO Configuration	Disabled	Disabled, Enabled
DITO Value	625	
DM Value	15	
Serial ATA Port 1	Empty	
Software Preserve	Unknown	
Port 1	Enabled	Disabled, Enabled
Hot Plug	Disabled	Disabled, Enabled
Configure as eSATA	Hot Plug supported	
External	Disabled	Disabled, Enabled
Spin Up Device	Disabled	Disabled, Enabled
SATA Device Type	Hard Disk Drive	Hard Disk Drive, Solid State Drive
Topology	Unknown	Unknown, ISATA, Direct connect, Flex, M2
SATA Port 1 DevSlp	Disabled	Disabled, Enabled
DITO Configuration	Disabled	Disabled, Enabled
DITO Value	625	
DM Value	15	
Serial ATA Port 2	Empty	
Software Preserve	Unknown	
Port 2	Enabled	Disabled, Enabled
Hot Plug	Disabled	Disabled, Enabled
Configure as eSATA	Hot Plug supported	
External	Disabled	Disabled, Enabled
Spin Up Device	Disabled	Disabled, Enabled
SATA Device Type	Hard Disk Drive	Hard Disk Drive, Solid State Drive
Topology	Unknown	Unknown, ISATA, Direct connect, Flex, M2
SATA Port 2 DevSlp	Disabled	Disabled, Enabled
DITO Configuration	Disabled	Disabled, Enabled

Sub-screen	BIOS Defaults	Possible Setting
DITO Value	625	
DM Value	15	
▶ USB Configuration		
xDCI Support	Disabled	Disabled, Enabled
USB2 PHY Sus Well Power Gating	Enabled	Disabled, Enabled
USB PDO Programming	Enabled	Disabled, Enabled
USB Overcurrent	Enabled	Disabled, Enabled
USB Overcurrent Lock	Enabled	Disabled, Enabled
USB Audio Offload	Enabled	Disabled, Enabled
USB Enable HSII on xHCI	Enabled	Disabled, Enabled
USB3.1 Portx Speed Selection	0	0-15
USB Port Disable Override	Disable link	Disable link, Select Per-Pin
▶ TSN GBE Configuration		
PCH LAN Controller	No GbE Region	
Port 80h Redirection	LPC Bus	LPC Bus, PCIE Bus
Enhance Port 80h LPC Decoding	Enabled	Disabled, Enabled
PCH LAN Controller	Disabled	

## 12.7. Security Setup Menu

Figure 20: Security Setup Menu Example

Aptio Setup - AMI					
Main	Advanced	Power	Boot	Security	Save & Exit
Password Description  If ONLY the Administrator's password is set, then this only limits access to Setup and is only asked for when entering Setup If ONLY the User's password is set, then this is a power on password and must be entered to boot or enter Setup. In Setup the User will have Administrator rights. The password length must be in the following range: Minimum Length 3 Maximum length 20 Administrator Password User Password  ► Secure Boot					
				→ ←: Select Screen  ↑ ↓: Select Item Enter: Select +/-: Change Opt. F1: General Help F2: Previous Values F3: Optimized Defaults F4: Save & Reset ESC: Exit	

The following table gives more information about important setup options within the Security Menu.

Table 29: Security Setup Menu Sub-screen

Sub-screen	BIOS Default	Possible Settings
System Mode	Setup	
Secure Boot	Disabled	Disabled, Enabled
	Not Active	
Secure Boot Mode	Standard	Standard, Custom
► Restore Factory Keys		
► Reset to Setup Mode		
► Key Management		

Sub-screen	BIOS Default	Possible Settings
Vendor Keys	Valid	
Factory Key Provision	Disabled	Disabled, Enabled
▶ Restore Factory Keys		
▶ Reset to Setup Mode		
▶ Enroll Efi Image		
▶ Export Secure Boot variables		
Secure Boot variable		
▶ Platform Key (PK)		
▶ Key Exchange Keys		
▶ Authorized Signatures		
▶ Forbidden Signatures		
▶ Authorized TimeStamps		
▶ OsRecovery Signatures		



UEFI only! No legacy support and no Master Boot Record (MBR) installation.

## 12.8. Boot Setup Menu

Figure 21: Boot Setup Menu Example

Aptio Setup - AMI					
Main	Advanced	Power	Boot	Security	Save & Exit
Boot Configuration					
Setup Prompt Timeout		[1]			
Bootup NumLock State		[Off]			
Quiet Boot		[Disabled]			
Fixed Boot order		[Enabled]			
Boot Option Priorities				→ ←: Select Screen ↑ ↓: Select Item Enter: Select +/-: Change Opt. F1: General Help F2: Previous Values F3: Optimized Defaults F4: Save & Reset ESC: Exit	
Boot Option #1		[xxxxx]			
▶ UEFI Hard Disk Drive BBS Priorities					
▶ UEFI Application Boot Priorities					

The following table gives more information about important setup options within the Boot menu.

Table 30: Boot Setup Menu Sub-screens

Sub-screen	BIOS Default	Possible Settings
Boot Configuration		
Setup Prompt Timeout	1	1-65535 Displays number of seconds the firmware waits for setup activation key. (65535 (0xFFFF) means an indefinite wait)
Bootup NumLock State	Off	On, Off
Quiet Boot	Disable	Disabled, Enabled
Fixed Boot Order	Enabled	Disabled, Enabled
Boot Option Priorities		
Boot Option #1	XXXXXX	
▶ UEFI Hard Disk Drive BBS Priorities		
Boot Option #1	XXXXXX	
▶ UEFI Application Boot Priorities		
Boot Option #1	UEFI: Built-in EFI Shell	UEFI: Built-in EFI Shell, Disabled

## 12.9. Save and Exit Setup Menu

Figure 22: Save and Exit Setup Menu Example

Aptio Setup - AMI					
Main	Advanced	Power	Boot	Security	Save & Exit
Save Options					
Save Changes and Exit					
Discard Changes and Exit					
Save Changes and Reset					
Discard Changes and Reset					
Save Changes					
Discard Changes					
Default Options				→ ←: Select Screen	
Restore Defaults				↑ ↓: Select Item	
Save as User Default				Enter: Select	
Restore User Defaults				+/-: Change Opt.	
Boot Override				F1: General Help	
UEFI: Built-in EF Shell				F2: Previous Values	
XXXXX				F3: Optimized Defaults	
				F4: Save & Reset	
				ESC: Exit	

The following table gives more information about important setup options within the Save and Exit Menu.

Table 31: Save and Exit Setup Menu Sub-screens

Sub-screen	Description
Save Changes and Exit>	Exits system after saving changes
Discard Changes and Exit>	Exits system setup without saving changes
Save Changes and Reset>	Reset system after saving changes
Discard Changes and Reset>	Resets system setup without saving changes
Save Changes>	Saves changes made so far for any setup options
Discard Changes>	Discards changes made so far to the setup values and restore the previously saved values.
Restore Defaults>	Restores/loads standard default values for all setup options
Save as User Defaults>	Saves changes made so far as user defaults
Restore User Defaults>	Restores user defaults to all setup options
UEFI Built-in EFI shell>	Attempts to launch the built in EFI Shell

## 13/ Maintenance and Prevention

Kontron products require only minimum servicing and maintenance for problem-free operation.

For FlatClient variants including a service flap on the rear panel devices behind the service flat can be installed and exchanged. For FlatClient variants without a service flap there are no user serviceable parts.

If problems of a technical nature occur, contact [Kontron Support](#). Kontron recommends returning the FlatClient to Kontron to avoid damage, see Chapter 14.1: Returning Defective Merchandise.

---

### Handling and Operation

#### ⚠ CAUTION

Handling and operation of the product is permitted only for trained personnel aware of the associated dangers, within a workplace that is access-controlled and fulfills all necessary technical and environmental requirements.

---

### Protection Label

#### NOTICE

The product is factory configured to meet customer requirements and then sealed with a protection label. Opening the product invalidates the warranty and may cause damage to internal components.

---

### Internal Components not Accessible

#### NOTICE

For replacement or installation of internal components, Kontron recommends users to return the product to Kontron to avoid damage. For more information, see Chapter 14.1: Returning Defective Merchandise.

---

### 13.1. Cleaning the Front

Before cleaning the front, read the instructions within this chapter to prevent damage to the display.

#### Penetration of liquids

#### NOTICE

The display (cover glass and frame) is IP65 protection class rated and may be cleaned with a liquid cleaner.

---

#### Damage to Display Surface

#### NOTICE

When cleaning the display, do not apply any pressure or use an abrasive substance/cloth that might scratch or damage the display's surface.

---

When cleaning the front:

- Use a clean and soft microfiber cloth.
- Use a commercially available glass cleaner or Ethanol Alcohol.
- Gently wipe the display with a cloth dampened with the glass cleaner.
- Do not press on the display when cleaning.

## 13.2. Cleaning the Rear Panel

Before cleaning the rear panel, read the instructions within this chapter, to prevent personal injury and damage to the FlatClient or the housing.



### Caution: Hot Surface

The heatsink/rear panel can get hot. To avoid burns and personal injury when handling the heatsink/rear panel:

- › Do not touch while in operation
- › Allow to cool before handling
- › Wear protective gloves

### NOTICE

#### Avoid Penetration of Liquids!

The rear panel with connector panel is rated with the IP20 protection class; and may be damaged if liquids enter through openings. Do not pour or spray any liquid directly onto the rear panel.

### NOTICE

#### Chemical Substance Damage

Do not use a chemical substance on the rear panel, this may damage the lettering and varnish finish.

When cleaning the rear panel:

- › Ensure the product is not in operation and has cooled sufficiently.
- › Do not pour or spray any liquid directly onto the rear panel.
- › Use a clean and soft microfiber cloth.
- › Use warm soapy water only.
- › Do not use a chemical substance when cleaning the rear panel, this may damage the lettering and varnish finish.
- › Gently wipe the rear panel with a cloth dampened with warm soapy water.

## 13.3. Replacing the Internal RTC Lithium Battery

An empty RTC lithium battery BIOS does not affect the BIOS settings. However, the system time and date are affected and must be reconfigured after replacing the battery.

For replacement of the internal RTC lithium battery, returning the product to Kontron, see Chapter 14.1: Returning Defective Merchandise.

## 13.4. Exchanging the Automotive RTC Lithium Battery (option)

The automotive RTC lithium battery module is an option and accessible to the user by opening the rear panel service flap.

### CAUTION

#### Danger of Explosion if the lithium battery is incorrectly placed!

- › Replace only with the same or equivalent type recommended by the manufacturer
- › Dispose of used batteries according to the manufacturer's instructions

**⚠ CAUTION****Switch Off Properly**

Before opening the service flap, switch off and disconnect by removing the power cable from the Power IN connector or the power source.



An empty RTC lithium battery BIOS does not affect the BIOS settings. However, the system time and date are affected when the RTC lithium battery is empty and must be reconfigured after replacing the battery.



When booting after replacing the RTC lithium battery, the boot time is longer, as the 3.5"-SBC-board performs several reboots before startup.



Do not dispose of lithium batteries in general trash collection. Dispose of the lithium battery according to the local regulations dealing with the disposal of these special materials, (e.g. to the collecting points for disposal of batteries).

**Figure 23: Automotive Battery Service Flap**

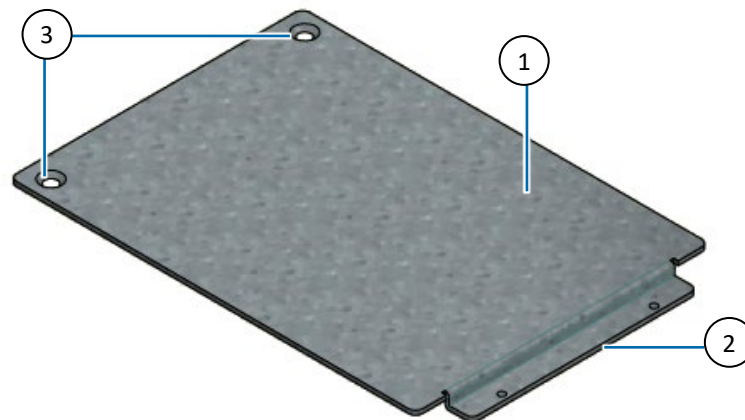

- |                         |                                   |
|-------------------------|-----------------------------------|
| 1. Service flap         | 3. 2x Service flap screw openings |
| 2. Service flap bracket |                                   |

To exchange the automotive battery module with BR2450 battery, perform the following:

1. Switched off and disconnected the product from the power source by removing the power cable.
2. Remove and retain the two screws fastening the service flap to the rear cover.
3. Slide the service flap to release the service flap bracket.
4. Locate the BAT header and remove the automotive battery cable.
5. Remove and retain the four screws on the automotive battery module.
6. Fasten a new automotive RTC battery module using the screws retained in step 4.
7. Insert the automotive battery cable into the BAT header.
8. Slide the service flap bracket into place and fasten the service flap with the screws retained in step 1.

## 13.5. Exchanging the 2.5" SSD (option)

### Switch Off properly

#### ⚠ CAUTION

Before opening the service flap, switched off and disconnected, by disconnecting the power cable from the Power IN connector or the power source.



After installing or removing a SSD drive, memory partitioning may be different and require repartitioning.

Figure 24: 2.5" SSD Service Flap

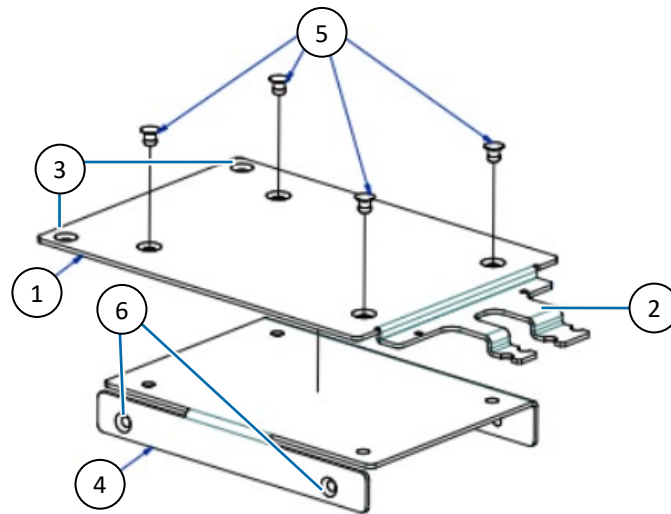

- |   |   |
|---|---|
| 1. 2.5" SSD service flap                | 4. 2.5" SSD holder                              |
| 2. 2.5" SSD service flap bracket        | 5. 2.5" SSD holder fastening screws             |
| 3. 2.5" SSD service flap screw openings | 6. 2.5" SSD screw openings (left & right sides) |

The 2.5" SSD is accessed through the service flap. To exchangeable the 2.5" SSD, perform the following:

1. Switched off and disconnected the product from the power source by removing the power cable.
2. Remove and retain the two screws fastening the service flap to the rear cover.
3. Slide the service flap to release the service flap bracket.
4. Disconnect the data and power cables from the 2.5" SSD.
5. Remove the four screws fastening the SSD holder to the service flap. Retain the screws for later use.
6. Remove the two screws on each side of the SSD holder securing the 2.5" SSD. Retain the screws for later use.
7. Replace with a new 2.5" SSD
8. Fasten the 2.5" SSD to the SSD holder on the left and right sides, using the screws retained in step 5.
9. Fasten the SSD holder to the service flap using the screws retained in step 4.
10. Connect the data and power cables to the 2.5" SSD.
11. Slide the service flap bracket into place and fasten the service flap with the screws retained in step 1.

## 14/ Technical Support

For technical support contact our Support Department:

- › E-mail: [support@kontron.com](mailto:support@kontron.com)
- › Phone: +49-821-4086-888

Make sure you have the following information available when you call:

- › Product ID Number (PN),
- › Serial Number (SN)



The serial number can be found on the Type Label, located on the product's rear panel.

---

Be ready to explain the nature of your problem to the service technician.

### 14.1. Returning Defective Merchandise

All equipment returned to Kontron must have a Return of Material Authorization (RMA) number assigned exclusively by Kontron. Kontron cannot be held responsible for any loss or damage caused to the equipment received without an RMA number. The buyer accepts responsibility for all freight charges for the return of goods to Kontron's designated facility. Kontron will pay the return freight charges back to the buyer's location in the event that the equipment is repaired or replaced within the stipulated warranty period. Follow these steps before returning any product to Kontron.

1. Visit the RMA Information website: <https://www.kontron.com/en/support/rma-information>
2. Download the RMA Request sheet for Kontron Europe GmbH and fill out the form. Take care to include a short detailed description of the observed problem or failure and to include the product identification Information (Name of product, Product number and Serial number). If a delivery includes more than one product, fill out the above information in the RMA Request form for each product. Send the completed RMA-Request form to the fax or email address given below at Kontron Europe GmbH. Kontron will provide an RMA-Number.
3. Kontron Europe GmbH  
RMA Support  
Phone: +49 (0) 821 4086-0  
Fax: +49 (0) 821 4086 111  
Email: [service@kontron.com](mailto:service@kontron.com)
4. The goods for repair must be packed properly for shipping, considering shock and ESD protection.



Goods returned to Kontron Europe GmbH in non-proper packaging will be considered as customer caused faults and cannot be accepted as warranty repairs

---

5. Include the RMA-Number with the shipping paperwork and send the product to the delivery address provided in the RMA form or received from Kontron RMA Support.

## 15/ Storage and Transportation

### 15.1. Storage

If the product is not in use for an extended period time, disconnect the power plug from the power supply. If it is necessary to store the product then re-pack the product as originally delivered to avoid damage. The storage facility must meet the product's environmental storage requirements as stated within this user guide. Kontron recommends keeping the original packaging material for future storage or warranty shipments.

### 15.2. Transportation

To ship the product, use the original packaging, designed to withstand impact and adequately protect the product. When packing or unpacking products, always take shock and ESD protection into consideration and use an EOS/ESD safe working area.

## 16/ Warranty

Due to their limited service-life, parts that by their nature are subject to a particularly high degree of wear (wearing parts) are excluded from the warranty beyond that provided by law. For example, this applies to the lithium battery.

---

**NOTICE****Protection Label**

The product is factory configured to meet customer requirements and then sealed with a protection label. Opening the product invalidates the warranty and may cause damage to internal components.

---

## 17/ Disposal

### 17.1. Disposal

Dispose of the product in accordance with country, state, or local regulations and requirements as part of your disposal and decommissioning policies or recycle the product or parts of the product for re-use after performing data sanitization to erase sensitive data stored on the product's memory devices.

When disposing of the product

- › Remove any product labels from the product that could indicate ownership and provide a clue to the type of data stored on the memory device.
- › Comply with your company's environmental requirements and the requirements of Waste Electrical and Electronic Equipment (WEEE) directive.
- › Use data sanitization guidelines to ensure that data sensitive to your business and/or confidential or proprietary data and software is removed from the product using a data sanitization method that stops the data from being retrieved or reconstructed.

### 17.2. WEEE Compliance

The Waste Electrical and Electronic Equipment (WEEE) Directive aims to:

- › Reduce waste arising from electrical and electronic equipment (EEE).
- › Make producers of EEE responsible for the environmental impact of their products, especially when the product becomes waste.
- › Encourage separate collection and subsequent treatment, reuse, recovery, recycling and sound environmental disposal of EEE.
- › Improve the environmental performance of all those involved during the lifecycle of EEE.



Environmental protection is a high priority with Kontron.  
Kontron follows the WEEE directive  
You are encouraged to return our products for proper disposal.

### 17.3. Data Sanitization

Data sanitization is the process of permanently erasing or destroying sensitive data on the product's memory devices to prevent unauthorized access to data sensitive to your business and/or confidential/proprietary data stored on the memory devices.

When designing a system, the user must plan for data sanitization and design in memory devices that are easier to sanitize, memory devices from manufacturers that provide an effective data erasure tool or a return to factory default command.

When performing data sanitization, the user must consider if the product's memory devices contain sensitive data and develop a data sanitization plan to erase all sensitive data in accordance with country, state, or local data sanitization regulations and requirements or as part of your disposal and decommissioning policies.



#### Data Sanitization

Users are responsible for erasing sensitive data on memory devices in accordance with country, state, or local data sanitization regulations and requirements, or as part of your disposal and decommissioning policies.

Kontron recommends performing data sanitization when reusing the product in a different user environment, sending the product in for repair, disposing of the product or decommissioning the product.

General guidelines when performing data sanitization on memory devices containing data sensitive to your business and/or confidential/proprietary data:

- › Before powering down, consider if power is required to perform data sanitization on the product’s memory devices.
- › When disconnected from the power source, dismantle all removable memory devices from the product and erase sensitive data.
- › Volatile memory devices only store data temporarily. Data on volatile memory can be erased easily by disconnecting the power/removing the battery for approximately 24 hours.
- › Non-volatile memory devices store data permanently and retain information when disconnected from power. Data on non-volatile memory must be actively erased using one of the following methods:
  - › Use an accredited third-party software tool that provides an audit trail, capable of performing a complete data clean including areas such as hidden data and bad blocks not accessed by general service-based utilities.
  - › Use the physical destruction methods on memory devices that cannot be securely software erased. The aim of the destruction is to break the silicon die within the chips package into two or more parts to prevent reading data from the die. Fragments should be no longer than 6 mm. If this service is performed by a third party obtain destruction certificates for confirmation.
  - › Use the manufacturer’s data erasure tool for sanitization or return to factory default command (if provided by the manufacturer). The manufacturer’s tools and commands have been designed to fulfil the data sanitization requirement of the manufacturer’s specific memory device(s).
- › Always verify that all sensitive data has been effectively sanitized.



#### **Dismantle Removable Memory**

Dismantle all removable memory devices and erase sensitive data for reuse by using:

- › An accredited third-party software tool.
- › Manufacturer’s data erasure tool’ or ‘return to factory default command’. (if provided)

If the removable memory is not for reuse, physically destruct the memory according to data sanitization guidelines.



#### **Erase Data**

To ensure that forensic tools cannot be used to recover sensitive data:

- › Use an accredited third-party software tool, with an audit trail, capable of performing a complete data clean including areas such as hidden data and bad blocks not accessed by general service-based utilities.
- › Use the manufacturer’s data erasure tool or return to factory default command designed to fulfil the data sanitization requirement of the manufacturer’s specific memory device(s).



#### **Physical Destruction**

When physically destructing the memory:

- › Follow proper safety protocols.
- › Break the chip packaged silicon die into two or more parts, fragments  $\leq$  6 mm.
- › Check both sides as memory devices may be positioned on the rear side.
- › Use a third-party destruction company providing certificates for confirmation.

## 17.4. Statement of Memory Volatility

The product's statement of memory volatility provides the user with a detailed list of the product's memory devices and their volatility, to enable the user to develop a suitable data sanitization plan.



In some cases, special tools and/or software are necessary to access the memory

Note that not all memory devices may be part of your delivered product. Some memory devices are options chosen by the user. Users are responsible for considering the memory devices installed on the product and must take appropriate action to clear the memory if required.

Third-party devices such as M.2 modules installed on the product may include memory devices and should be removed by the user before disposing of the product. It is the responsibility of the user to observe that the third-party devices are removed according to the manufacturer's instructions.



In some cases, special tools and/or software are necessary to access the memory



The Statement of Volatility list is an overview of all the known possible memory devices and due to configuration options may differ from your delivered product.

**Table 32: FlatClient PRO RPL Statement of Memory Volatility**

Memory Type	Ref. # / Loc.	Memory Size	Volatility	Retain Data when Power Off	Alterable in Field <sup>[1]</sup>	Battery Backed Up	Data Type	Write Protected	Emergency Erase	Process to Clear
DDR										
DDR5 SO-DIMM	SBC Board	Up to 48 GB	Volatile	No	Yes	No	User Data	No	No	NA
DDR5 SO-DIMM	SBC Board	Up to 48 GB	Volatile	No	Yes	No	User Data	No	No	NA
Embedded Controller (EC)										
Embedded Controller MEC1521	SBC Board	Code Storage: 480 KB (Code + Data) Data RAM: 32 KB	Non-volatile (Code storage) Volatile (RAM)	Yes	Yes	No	Embedded controller config.	Yes	No	Perform EC FW update
CMOS-FLASH SPI MX25V16 35FM2I	SBC Board	16 Mbit	Non-volatile	Yes	Yes	No	EFI Boot	Yes	Yes	Perform BIOS recovery
LAN										
FLASH SPI W25Q16J VSSIQ	SBC Board	16 Mbit	Non-volatile	Yes	Yes	No	EFI Boot	Yes (SW)	No	Perform BIOS recovery
BIOS										

Memory Type	Ref. # / Loc.	Memory Size	Volatility	Retain Data when Power Off	Alterable in Field <sup>[1]</sup>	Battery Backed Up	Data Type	Write Protected	Emergency Erase	Process to Clear
FLASH SPI W25Q256J VEIQ	SBC Board	256 Mbit	Non-volatile	Yes	Yes	No	EFI Boot	Yes (SW)	No	Perform BIOS recovery
EEPROM										
EEPROM AT24C32E-SSHM-T	SBC Board	32 Kbit	Non-volatile	Yes	Yes	No	Module ID Data	Yes	No	NA
LVDS										
EEPROM Chrontel CH9904	SBC Board	64 Kbit	Non-volatile	Yes	Yes	No	Module ID Data	Yes	No	NA
VCORE										
MP2964R	SBC Board	8 Kbit	Non-volatile	Yes	No	No	VR Config.	No	No	NA
TPM										
SLB 9672XU2.0	SBC Board	51 KByte	Non-volatile	Yes	Yes	No	User Data	Yes	No	Perform clear item under OS
M.2 Key M 2280 SSD										
M.2 2280 SSD <sup>[2]</sup>	SBC M.2 key M slot	Up to 1 TByte	Non-volatile	Yes	Yes	No	User data	No	No	Remove or use 3rd party overwrite tool

<sup>[1]</sup> Memory is an option and may not be included in your configuration.

<sup>[2]</sup> In some cases special tools and/or software are necessary to access the memory.

## 18/ Cyber Security

Cyber security is an important aspect to consider when installing, operating, maintaining and disposing the product. This chapter provides cyber security guidelines for the user.



### Security White Paper

For cyber security guidelines to protect your Kontron product from potential cyber security threats, refer to Kontron's [Security White paper](#).

---



### Security Measures

Kontron is not aware of the final target end user environment in which the product operates. It is not possible for Kontron to provide precise instructions for your cyber security measures. Kontron strives to provide hints for considerations for your threat analysis and to point out particular security mechanisms implemented in Kontron products.

---

### 18.1. Security Defense Strategy

When developing your security defense strategy consider implementing the following guidelines to help you effectively secure the product:

- › Policies and procedures developed in association with the product's/end environment's security.
- › Instructions and recommendations for periodic security maintenance activities and reporting product security incidents.
- › Security network controls/setting such as firewall rules.
- › Third party software tools that further protect the product.
- › Authentication to access the product, limit user privileges and managing user accounts.
- › Data encryption.
- › Reduced number of potential security entry points.
- › BIOS/OS and security updates that do not compromise the product's operation or defense in depth strategy.
- › User accounts with length and complexity requirements.
- › Supplied default passwords are changed.
- › Limited network access (IP address range).
- › Installation of anti-virus and malware software.
- › Network access requirements such as VPN.

## Appendix: List of Acronyms

<b>AC</b>	Alternating Current
<b>BT</b>	Bluetooth
<b>CAN</b>	Controller Area Network
<b>CE</b>	Conformité Européenne
<b>COM</b>	Communication port
<b>DC</b>	Direct Current
<b>DTR</b>	Dynamic Temperature Range
<b>DP</b>	Display Port
<b>EMC</b>	ElectroMagnetic compatibility
<b>ESD</b>	ElectroStatic Discharge
<b>FCC</b>	Federal Communications Commission
<b>GbE</b>	Giga Bit Ethernet
<b>HD</b>	High Definition
<b>HDMI</b>	High Definition Multimedia Interface
<b>IEC</b>	International Electrotechnical Commission
<b>IOT</b>	Internet of Things
<b>IP</b>	International Protection
<b>LAN</b>	Local Area Network
<b>LED</b>	Light Emitting Diode
<b>LPC</b>	Limited Power Source
<b>MDI</b>	Media Dependent Interface
<b>MTBF</b>	Mean Time Before Failure
<b>NvME</b>	Non-Volatile Memory Express
<b>PS</b>	Power Source
<b>PSU</b>	Power Supply Unit
<b>PWR</b>	Power
<b>RED</b>	Radio Equipment Directive
<b>RFID</b>	Radio Frequency Identification
<b>RMA</b>	Return of Material Authorization
<b>RoHS</b>	Restriction of Hazardous Substances
<b>RTC</b>	Real Time Clock
<b>RP-SMA</b>	Reverse Polarity Sub Miniature version A
<b>SD card</b>	Secure Digital Card
<b>SSD</b>	Solid State Drive
<b>SVGA</b>	Super Video Graphics Array
<b>TDP</b>	Thermal Design Power
<b>TPM</b>	Trusted Platform Module
<b>UEFI</b>	Unified Extensible Firmware Interface

<b>UL</b>	Underwriters Laboratories
<b>USB</b>	Universal Serial Bus
<b>UV</b>	Ultra Violet
<b>VESA</b>	Video Electronics Standards Association
<b>VGA</b>	Video Graphics Array
<b>WXGA</b>	Wide Extended Graphics Array
<b>XGA</b>	Extended Graphics Array



## About Kontron

Kontron is a global leader in IoT/Embedded Computing Technology (ECT) and offers individual solutions in the areas of Internet of Things (IoT) and Industry 4.0 through a combined portfolio of hardware, software and services. With its standard and customized products based on highly reliable state-of-the-art technologies, Kontron provides secure and innovative applications for a wide variety of industries. As a result, customers benefit from accelerated time-to-market, lower total cost of ownership, extended product lifecycles and the best fully integrated applications.

For more information, please visit: [www.kontron.com](http://www.kontron.com)

## Global Headquarters

Kontron Europe GmbH

Gutenbergstraße 2  
85737 Ismaning, Germany  
Tel.: +49 8214 4086-0  
[info@kontron.com](mailto:info@kontron.com)

[www.kontron.de](http://www.kontron.de)

