



KBox A-251

User Guide Rev. 1.3

Doc. ID: 1074-7818

This page has been intentionally left blank

KBox A-251 – User Guide

Disclaimer

Kontron would like to point out that the information contained in this user guide may be subject to alteration, particularly as a result of the constant upgrading of Kontron products. This document does not entail any guarantee on the part of Kontron with respect to technical processes described in the user guide or any product characteristics set out in the user guide. Kontron assumes no responsibility or liability for the use of the described product(s), conveys no license or title under any patent, copyright or mask work rights to these products and makes no representations or warranties that these products are free from patent, copyright or mask work right infringement unless otherwise specified. Applications that are described in this user guide are for illustration purposes only. Kontron makes no representation or warranty that such application will be suitable for the specified use without further testing or modification. Kontron expressly informs the user that this user guide only contains a general description of processes and instructions which may not be applicable in every individual case. In cases of doubt, please contact Kontron.

This user guide is protected by copyright. All rights are reserved by Kontron. No part of this document may be reproduced, transmitted, transcribed, stored in a retrieval system, or translated into any language or computer language, in any form or by any means (electronic, mechanical, photocopying, recording, or otherwise), without the express written permission of Kontron. Kontron points out that the information contained in this user guide is constantly being updated in line with the technical alterations and improvements made by Kontron to the products and thus this user guide only reflects the technical status of the products by Kontron at the time of publishing.

Brand and product names are trademarks or registered trademarks of their respective owners.

©2026 by Kontron Europe GmbH

Kontron Europe GmbH
Gutenbergstraße 2
85737 Ismaning
Germany
www.kontron.com

Intended Use

This device and associated software are not designed, manufactured or intended for use or resale for the operation of nuclear facilities, the navigation, control or communication systems for aircraft or other transportation, air traffic control, life support or life sustaining applications, weapons systems, or any other application in a hazardous environment, or requiring fail-safe performance, or in which the failure of products could lead directly to death, personal injury, or severe physical or environmental damage (collectively, “high risk applications”).

You understand and agree that your use of Kontron devices as a component in High Risk Applications is entirely at your risk. To minimize the risks associated with your products and applications, you should provide adequate design and operating safeguards. You are solely responsible for compliance with all legal, regulatory, safety, and security related requirements concerning your products. You are responsible to ensure that your systems (and any Kontron hardware or software components incorporated in your systems) meet all applicable requirements. Unless otherwise stated in the product documentation, the Kontron device is not provided with error-tolerance capabilities and cannot therefore be deemed as being engineered, manufactured or setup to be compliant for implementation or for resale as device in High Risk Applications. All application and safety related information in this document (including application descriptions, suggested safety measures, suggested Kontron products, and other materials) is provided for reference only.

NOTICE

You find the most recent version of the “General Safety Instructions” online in the download area of this product.

NOTICE

This product is not intended for use or suited for storage or operation in corrosive environments, in particular under exposure to sulfur and chlorine and their compounds. For information on how to harden electronics and mechanics against these stress conditions, contact Kontron Support.

Revision History

Revision	Brief Description of Changes	Date of Issue	Author
1.0	Initial version	24-Mar-2026	CW
1.1	Altered to enable the separation of 2.5"-SBC board and processor information. Added reverse polarity protection information in Ch. 4.1.1 and Ch. 4.1.2.	01-Apr-2026	CW
1.2	Updated RTC Battery information in Ch. 2.5, Ch. 4.7.4, Ch. 14.2 and Ch. 14.3. Updated the RS Mode Configuration for the dual serial port RS232/422/485 module in Ch 5.4.5. Changed COM to Serial Port in hardware descriptions.	17-Apr-2026	CW
1.3	Changed the 24 VDC Power range to 9 VDC to 36 VDC in Table 22: Hardware Spec.	12-May-2026	CW

Terms and Conditions

Kontron warrants products in accordance with defined regional warranty periods. For more information about warranty compliance and conformity, and the warranty period in your region, visit www.kontron.com/terms-and-conditions.

Kontron sells products worldwide and declares regional General Terms & Conditions of Sale, and Purchase Order Terms & Conditions. Visit www.kontron.com/terms-and-conditions.

For contact information, refer to the corporate offices contact information on the last page of this user guide or visit our website [CONTACT US](#).

Customer Support

Find Kontron contacts by visiting www.kontron.com/support-and-services.

Customer Service

As a trusted technology innovator and global solutions provider, Kontron extends its embedded market strengths into a services portfolio allowing companies to break the barriers of traditional product lifecycles. Proven product expertise coupled with collaborative and highly-experienced support enables Kontron to provide exceptional peace of mind to build and maintain successful products.

For more details on Kontron's service offerings such as: enhanced repair services, extended warranty, Kontron training academy, and more visit www.kontron.com/support-and-services.

Customer Comments

If you have any difficulties using this user guide, discover an error, or just want to provide some feedback, contact [Kontron support](#). Detail any errors you find. We will correct the errors or problems as soon as possible and post the revised user guide on our website.

Symbols

The following symbols may be used in this user guide



DANGER indicates a hazardous situation which, if not avoided, will result in death or serious injury.



WARNING indicates a hazardous situation which, if not avoided, could result in death or serious injury.



NOTICE indicates a property damage message.



CAUTION indicates a hazardous situation which, if not avoided, may result in minor or moderate injury
ATTENTION indique une situation dangereuse qui, si elle n'est pas évitée, peut entraîner des blessures mineures ou modérées.



Electric Shock!

This symbol and title warn of hazards due to electrical shocks (> 60 V) when touching products or parts of products. Failure to observe the precautions indicated and/or prescribed by the law may endanger your life/health and/or result in damage to your material.



ESD Sensitive Device!

This symbol and title inform that the electronic boards and their components are sensitive to static electricity. Care must therefore be taken during all handling operations and inspections of this product in order to ensure product integrity at all times.



Caution: HOT Surface!

Do NOT touch! Allow to cool before servicing.

Attention : Surface CHAUDE !

Ne pas toucher ! Laissez refroidir avant de procéder à l'entretien.



Caution: Laser!

This symbol and title inform of the risk of exposure to laser beam and light emitting devices (LEDs) from an electrical device. Eye protection per manufacturer notice shall review before servicing.



High sound pressure!

This symbol and title inform of the risk of hearing damage due to high sound pressure. Do not listen at high volume levels for long periods of time.

**Security**

This symbol indicates general information and guidelines regarding the product's cyber security to ensure secure installation, operation, maintenance and disposal of the product within the user's end environment.



This symbol indicates general information about the product and the user guide.
This symbol also indicates detailed information about the specific product configuration.



This symbol precedes helpful hints and tips for daily use.

For Your Safety

Your new Kontron product was developed and tested carefully to provide all the features necessary to ensure its compliance with electrical safety requirements. It was also designed for a long fault-free life. However, the life expectancy of your product can be drastically reduced by improper treatment during unpacking and installation. Therefore, in the interest of your own safety and of the correct operation of your new Kontron product, you are requested to conform with the following guidelines.

High Voltage Safety Instructions

As a precaution and in case of danger, the power connector must be easily accessible. The power connector is the product's main disconnect device.

⚠ CAUTION

Warning

All operations on this product must be carried out by sufficiently skilled personnel only.

⚠ CAUTION



Electric Shock!

Before installing a non hot-swappable Kontron product into a system always ensure that your mains power is switched off. This also applies to the installation of piggybacks. Serious electrical shock hazards can exist during all installation, repair, and maintenance operations on this product. Therefore, always unplug the power cable and any other cables which provide external voltages before performing any work on this product.

Earth ground connection to vehicle's chassis or a central grounding point shall remain connected. The earth ground cable shall be the last cable to be disconnected or the first cable to be connected when performing installation or removal procedures on this product.

Special Handling and Unpacking Instruction

NOTICE



ESD Sensitive Device!

Electronic boards and their components are sensitive to static electricity. Therefore, care must be taken during all handling operations and inspections of this product, in order to ensure product integrity at all times.

⚠ CAUTION

Handling and operation of the product is permitted only for trained personnel within a workplace that is access controlled. Follow the "General Safety Instructions" supplied with the product.

Do not handle this product out of the product's protective enclosure while the product is not used for operational purposes unless the product is otherwise protected.

Whenever possible, unpack or pack this product only at an EOS/ESD safe workplace. Where a safe workplace is not guaranteed, it is important for the user to be electrically discharged before touching the product with his/her hands or tools. This is most easily done by touching a metal part of your system housing.

It is particularly important to observe standard anti-static precautions when changing piggybacks, ROM devices, jumper settings etc. If the product contains batteries for RTC or memory backup, ensure that the product is not placed on conductive surfaces, including anti-static plastics or sponges. They can cause short circuits and damage the batteries or conductive circuits on the product.

Lithium Battery Precautions

If your product is equipped with a lithium battery, take the following precautions when replacing the lithium battery.

⚠ CAUTION

Risk of Explosion if the lithium Battery is replaced by an incorrect Type. Dispose of used lithium batteries according to the instructions.

Risque d'explosion si la pile au lithium est remplacée par une pile de type incorrect.
Éliminez les piles au lithium usagées conformément aux instructions.

General Instructions on Usage

In order to maintain Kontron's product warranty, this product must not be altered or modified in any way. Changes or modifications to the product, that are not explicitly approved by Kontron and described in this user guide or received from Kontron Support as a special handling instruction, will void your warranty.

This product should only be installed in or connected to systems that fulfill all necessary technical and specific environmental requirements. This also applies to the operational temperature range of the specific board version that must not be exceeded. If batteries are present, their temperature restrictions must be considered.

In performing all necessary installation and application operations, only follow the instructions supplied by the present user guide.

Keep all the original packaging material for future storage or warranty shipments. If it is necessary to store or ship the product then re-pack the product as delivered.

Special care is necessary when handling or unpacking the product, see the previous Special Handling and Unpacking Instruction.

Quality and Environmental Management

Kontron aims to deliver reliable high-end products designed and built for quality, and aims to comply with environmental laws, regulations, and other environmentally oriented requirements. For more information regarding Kontron's quality and environmental responsibilities, visit [Quality | Kontron](#) and [Material Compliance | Kontron](#).

Table of Contents

Disclaimer.....	3
Revision History.....	5
Symbols	6
For Your Safety	8
High Voltage Safety Instructions	8
Special Handling and Unpacking Instruction	8
Lithium Battery Precautions	9
General Instructions on Usage	9
Quality and Environmental Management	9
Table of Contents	10
List of Tables.....	12
List of Figures	13
1/ Introduction.....	15
2/ General Safety Instructions	17
2.1. Additional Safety Instructions for DC Power Supply Circuits	18
2.2. Instructions générales de sécurité	18
2.3. Electrostatic Discharge (ESD).....	19
2.4. Grounding Methods	20
2.5. Instructions for Lithium Battery	20
2.6. Thermal Conditions	21
3/ Shipment and Unpacking	22
3.1. Packaging.....	22
3.2. Unpacking.....	22
3.3. Scope of Delivery.....	22
3.4. Accessories and Spare Parts	23
3.5. Product Identification Type Label.....	24
4/ Product Features	25
4.1. Front Panel	25
4.1.1. Power IN 24 VDC (X101) (default)	26
4.1.2. Power IN 12 VDC (X101) (option)	26
4.1.3. Functional Earth Bolt	26
4.1.4. Power Button.....	26
4.1.5. State LED (STAT)	27
4.1.6. USB-C Port (X102)	27
4.1.7. USB 3.2 Gen 2 Ports (X103, X104)	27
4.1.8. Ethernet 2.5 GbE Ports (X105, X106).....	27
4.1.9. DisplayPorts (X107).....	28
4.1.10. Serial Port (X202).....	28
4.1.11. Serial Port (X201) (option).....	28
4.1.12. SIM Slot (X201) (option)	28
4.1.13. Antenna (X211, X212) (option).....	28
4.2. Left Side.....	30
4.3. Right Side.....	30
4.4. Rear Side.....	31
4.5. Top Side.....	31
4.6. Bottom Side.....	32
4.7. Internal 2.5"-SBC-Board Features	32
4.7.1. 2.5"-SBC-AML/ADN On-board Components.....	33
4.7.2. 2.5"-SBC-AML/ADN Expansion Sockets	34
4.7.3. Maximum Processor Power and Temperature.....	35
4.7.4. RTC Lithium Battery.....	35
5/ System Expansion.....	36
5.1. Before Expanding	36
5.2. Storage Expansion	36
5.3. Wireless Expansion Options	36

5.3.1. Wi-Fi.....	36
5.3.2. Cellular LTE	37
5.4. System Expansion I/O Door	38
5.4.1. Dual LAN	40
5.4.2. Dual CAN.....	40
5.4.3. EtherCAT	40
5.4.4. Dual Serial Ports (RS232)	41
5.4.5. Dual Serial Ports (RS232/422/485)	41
5.4.6. 8-Channel GPIO/DIO	42
6/ Thermal and Power Management.....	44
6.1. Passive Cooling	44
6.2. Heatsink.....	44
6.3. Mount Orientation	44
6.4. Minimum Heatsink Clearance	44
6.5. Power Consumption and Thermal Monitoring.....	45
6.6. Derating TDP Curves.....	45
6.7. Configuring the Processor TDP.....	47
6.8. Third Party Components.....	47
7/ Assembly	48
8/ Installation.....	49
8.1. Before Installing	49
8.2. Control Cabinet Mounting.....	49
8.3. DIN Rail Clamp	50
8.4. Rugged DIN Rail Clamp	50
8.5. Clearance.....	50
9/ Starting UP.....	52
9.1. Before Starting	52
9.2. Connecting to an External 24 VDC Power Supply.....	53
9.2.1. Wiring the Power IN Connector.....	54
9.3. Connecting to an External 12 VDC Power Supply.....	54
9.4. Operating System (OS) and Drivers	55
10/ Mobile Network	56
10.1. Before Setting Up	56
10.2. Setting up the Mobile Network.....	56
10.3. Inserting a SIM Card	56
11/ Product Specification	57
11.1. Block Diagram.....	57
11.2. Hardware Specification	58
11.3. Software Specification.....	59
11.4. Power Specifications	59
11.4.1. External 24 VDC Power Supply	59
11.4.2. External 12 VDC Power Supply	60
11.4.3. Power Supply Protection Requirements.....	61
11.4.4. Power Consumption	61
11.4.5. Functional Earth.....	62
11.5. Environmental Specification.....	63
11.6. Mechanical Specification.....	63
11.7. Compliance.....	65
12/ Connectors and LEDs.....	66
12.1. Front Panel Connector Pin Assignments	66
12.1.1. Power IN 24 VDC (X101)(default)	66
12.1.2. Power IN 12 VDC Connector (X101) (option)	66
12.1.3. USB-C Port (X102).....	67
12.1.4. USB 3.2 Gen 2 Ports (X103, X104)	68
12.1.5. Ethernet 2.5 GbE Ports (X105, X106).....	68
12.1.6. DisplayPort Connectors (X107).....	69
12.1.7. Serial Port Connectors (X202) and (X201 option).....	70

12.1.8. SIM Slot Card Holder (X201, option).....	70
12.1.9. Antenna Connectors (X211, X212).....	70
12.2. System Expansion I/O Door Options	72
12.2.1. Cellular LTE Antenna (X213, X214)	72
12.2.2. Dual LAN Connectors (X241, X242).....	73
12.2.3. Dual CAN Bus Connectors (X203, X204)	73
12.2.4. EtherCAT Connectors (X221, X222)	74
12.2.5. Dual Serial Port Connectors RS232 (X203, X204)	74
12.2.6. Dual Serial Port Connectors RS232/422/485 (X203, X204)	75
12.2.7. 8-Channel GPIO/DIO Connector (X231).....	76
12.3. On board Header Pin Assignments.....	76
12.3.1. RTC Power Input Header	76
13/ BIOS	77
13.1. Starting the uEFI BIOS.....	77
13.2. BIOS Update	78
13.3. Setup Menus	78
13.4. Main Setup Menu	79
13.5. Advances Setup Menu.....	81
13.6. Chipset Menu	90
13.7. Security Setup Menu	100
13.8. Boot Setup Menu	102
13.9. Save and Exit Setup Menu.....	103
14/ Maintenance and Prevention.....	104
14.1. Cleaning.....	104
14.2. Replacing the RTC Lithium Battery	105
14.3. Replacing the Automotive RTC Lithium Battery	106
14.4. Inserting and Extracting a SIM Card	108
15/ Technical Support.....	110
15.1. Returning Defective Merchandise.....	110
16/ Storage and Transportation	111
16.1. Storage	111
16.2. Transportation.....	111
17/ Warranty	112
18/ Disposal	113
18.1. Disposal	113
18.2. WEEE Compliance.....	113
18.3. Data Sanitization	113
18.4. Statement of Memory Volatility.....	115
19/ Cyber Security	117
19.1. Security Defense Strategy	117
Appendix: List of Acronyms.....	118

List of Tables

Table 1: Scope of Delivery- KBox A-251 (24 VDC variant)	22
Table 2: Scope of Delivery - KBox A-251 (12 VDC variant)	22
Table 3: Accessories and Spare Parts	23
Table 4: Product Identification based on AML/ADN Processor Platform	24
Table 5: State LED Description	27
Table 7: 2.5"-SBC Board M.2 Expansion Sockets.....	34
Table 6: Processor TDP and Maximum Temperature Values	35
Table 8: Storage SSD Module Specification.....	36
Table 9: Wi-Fi Module Specification.....	37

Table 10: Cellular LTE Module Specification	38
Table 11: System Expansion I/O Door Combination Overview	39
Table 12: System Expansion I/O Door Plates 1 to 4	39
Table 13: Dual LAN Module.....	40
Table 14: Dual CAN Module	40
Table 15: EtherCAT Module	40
Table 16: Dual Serial Port (RS232) Module	41
Table 17: DUAL Serial Port (RS232/422/485) Module	41
Table 18: RS Mode Configuration	41
Table 19: GPIO Input Channel Specification.....	42
Table 20. GP Output Channels Specification.....	43
Table 21: Power Consumption Example with 15 W Processor	45
Table 22: Hardware Specification	58
Table 23: Software Specification.....	59
Table 24: Electrical Specification External 24 VDC Power Supply (default)	60
Table 25: Electrical Specification External 12 VDC Power Supply (option)	60
Table 26: Power Consumption Interfaces and System Expansion I/O Door Options.....	62
Table 27: Environmental Specification.....	63
Table 28: Mechanical Specification.....	63
Table 29: Compliance	65
Table 30: Power IN Connector Pin Assignment.....	66
Table 31: 12 VDC Power Connector Pin Assignment	66
Table 32: USB-C Port Pin Assignment.....	67
Table 33: USB 3.2 Gen 2 Type A Port Pin Assignment.....	68
Table 34: Ethernet 2.5 GbE Port Pin Assignment	68
Table 35: DisplayPort Connector Pin Assignment	69
Table 36: Serial Port (RS232) Pin Assignment	70
Table 37: Antenna Type	70
Table 38: Cellular LTE Antenna Connectors	72
Table 39: Dual (2.5 GbE) LAN Ports Pin Assignment	73
Table 40: Dual CAN Ports Pin Assignment.....	73
Table 41: EtherCAT Port Pin Assignment	74
Table 42: Dual Serial Port (RS232) Pin Assignment	74
Table 43: Dual Serial Port (RS232/422/485) Pin Assignment.....	75
Table 44: GPIO/DIO Connector Pin Assignment.....	76
Table 45: RTC Power Input Header Pin Assignment.....	76
Table 46: Navigation Hot Keys	77
Table 47: Advanced Setup Menu Sub-screens Example	82
Table 48: Chipset Setup Menu Sub-screens Example	90
Table 49: Security Setup Menu Sub-screens Example	100
Table 50: Boot Setup Menu Sub-screens Example.....	102
Table 51: Save and Exit Setup Menu Sub-screens Example	103
Table 52: Statement of Memory Volatility Example - KBox A-251.....	115

List of Figures

Figure 1: KBox A-251	15
Figure 2: Type Label 24 VDC and 12 VDC Variants Examples.....	24
Figure 3: Front Panel	25
Figure 4: Wi-Fi and Cellular LTE Connectors and Antenna Type	29

Figure 5: Left Side.....	30
Figure 6: Right Side.....	30
Figure 7: Rear Side.....	31
Figure 8: Top Side.....	31
Figure 9: Bottom Side.....	32
Figure 10: 2.5"-SBC-AML/ADN - Top Side	33
Figure 11: 2.5"-SBC-AML/ADN - Bottom Side	34
Figure 12: RTC Lithium Battery Installed	35
Figure 13: Input Application Connected to GPIO	42
Figure 14: Output Application Connected to GPIO	43
Figure 15: Derating TDP versus Temperature Curves (without expansion & airflow 0.8 m/s)	45
Figure 16: Derating TDP versus Temperature Curves (with full load & airflow 0.8 m/s)	46
Figure 17: Derating TDP versus Temperature Curves (with full load & without airflow).....	46
Figure 18: Derating Current USB-C Port (X102) versus Temperature Curve	46
Figure 19: DIN Rail Clamp and Rugged DIN Rail Clamp (default position)	49
Figure 20: Connector Clearance	51
Figure 21: 24 VDC Power IN Connector and Mating Power Connector	53
Figure 22: Power IN 12 VDC Connector and Mating Power Connector	54
Figure 23: SIM Card Holder	56
Figure 24: Block Diagram - KBox A-251-AML/ADN.....	57
Figure 25: Voltage/Power Derating and Consumption/Capacity Curve Examples.....	61
Figure 26: Mechanical Dimensions (mm).....	64
Figure 27: Main Setup Menu Example	79
Figure 28: Advances Setup Menu Example	81
Figure 29: Chipset Menu Example.....	90
Figure 30: Security Setup Menu Example	100
Figure 31: Boot Setup Menu Example.....	102
Figure 32: Save and Exit Setup Menu Example	103
Figure 33: RTC Lithium Battery and Battery Header	105
Figure 34: Automotive RTC Lithium Battery Module and Battery Header.....	107

1/Introduction

This user guide describes the KBox A-251, also known as product within this user guide. This user guide focuses on describing the product's special features and how to assemble, install, operate, maintain and dispose of the product properly. New users are recommended to study the instructions within this user guide before switching on the product.

Based on Kontron's 2.5" Single Board Computer (SBC) family the KBox A-251 supports a variety of external interfaces to enable extensive connectivity, additional storage and wireless features such as Wi-Fi/Bluetooth® and cellular LTE. The system expansion I/O door expands the product's functionality, with a wide variety of expansion options.

The KBox A-251 is a flexible fanless industrial grade DIN Rail embedded box PC designed for use in applications requiring flexible DIN Rail mounting in limited space, continuous operation and longtime industrial deployment. All components are selected to ensure a long lifetime and the fanless design ensures a significantly prolonged lifespan and high system availability.

Figure 1: KBox A-251



The main KBox A-251 features are:

- 2.5"-SBC-board
- System memory up to 16 GByte LPDDR5 memory down
- Up to 128 GByte eMMC Storage
- Up to 2 TByte via M.2 Key B SSD (option)
- Front Panel Interfaces:
 - 1x DisplayPorts (DP)
 - 2x USB 3.2 Gen 2 Ports
 - 1x USB-C Port, with DP-Alt-Mode
 - 2x 2.5 GbE Ports
 - 1x Serial Port RS232
 - Wi-Fi 6E/Bluetooth® 5.3 (option)
- Metal chassis with heatsink
- Fanless passive cooling
- Power IN 24 VDC
 - 12 VDC (option)

- › System Expansion I/O Door (options)
 - › Cellular LTE
 - › Dual LAN (2.5 GbE)
 - › Dual CAN
 - › EtherCAT
 - › Dual Serial Ports (RS232)
 - › Dual Serial Ports (RS232/422/485 configurable)
 - › 8-channel GPIO/DIO



To ensure you have the latest version of this user guide, visit the [KBox A-Series](#) web site

2/General Safety Instructions

Please read this passage carefully and take careful note of the instructions, which have been compiled for your safety and to ensure to apply in accordance with intended regulations. If the following general safety instructions are not observed, it could lead to injuries to the operator and/or damage of the product; in cases of non-observance of the instructions Kontron Europe is exempt from accident liability, this also applies during the warranty period.

The product has been built and tested according to the basic safety requirements for low voltage (LVD) applications and has left the manufacturer in safety-related, flawless condition. To maintain this condition and to also ensure safe operation, the operator must not only observe the correct operating conditions for the product but also the following general safety instructions:

- The product must be used as specified in the product documentation, in which the instructions for safety for the product and for the operator are described. These contain guidelines for setting up, installation and assembly, maintenance, transport or storage.
- The on-site electrical installation must meet the requirements of the country's specific local regulations.
- If a power cable comes with the product, only this cable should be used. Do not use an extension cable to connect the product.
- To guarantee that sufficient air circulation is available to cool the product, please ensure that the ventilation openings are not covered or blocked. If a filter mat is provided, this should be cleaned regularly. Do not place the product close to heat sources or damp places. Make sure the product is well ventilated.
- Only connect the product to an external power supply providing the voltage type (AC or DC) and the input power (max. current) specified on the Kontron Product Label and meeting the requirements of the Limited Power Source (LPS) and Power Source (PS2) of UL/IEC 62368-1 .
- Only products or parts that meet the requirements for Power Source (PS1) of UL/IEC 62368-1 may be connected to the product's available interfaces (I/O).
- Before opening the product, make sure that the product is disconnected from the mains.
- Switching off the product by its power button does not disconnect it from the mains. Complete disconnection is only possible if the power cable is removed from the wall plug or from the product. Ensure that there is free and easy access to enable disconnection.
- The product may only be opened for the insertion or removal of add-on cards (depending on the configuration of the product). This may only be carried out by qualified operators.
- If extensions are being carried out, the following must be observed:
- all effective legal regulations and all technical data are adhered to
 - the power consumption of any add-on card does not exceed the specified limitations
 - the current consumption of the product does not exceed the value stated on the product label
- Only original accessories that have been approved by Kontron Europe can be used.
- Please note: safe operation is no longer possible when any of the following applies:
 - the product has visible damages or
 - the product is no longer functioning
 In this case the product must be switched off and it must be ensured that the product can no longer be operated.
- Handling and operation of the product is permitted only for trained personnel within a work place that is access controlled.
- CAUTION: Risk of explosion if the lithium battery is replaced incorrectly (short-circuited, reverse-poled, wrong lithium battery type). Dispose of used lithium batteries according to the manufacturer's instructions.
- This product is not suitable for use in locations where children are likely to be present

2.1. Additional Safety Instructions for DC Power Supply Circuits

- To guarantee safe operation, please observe that:
 - the external DC power supply must meet the criteria for LPS and PS2 (UL/IEC 62368-1)
 - no cables or parts without insulation in electrical circuits with dangerous voltage or power should be touched directly or indirectly
 - a reliable functional earth connection is provided
 - a suitable, easily accessible disconnecting device is used in the application (e.g. overcurrent protective device), if the product itself is not disconnectable
 - a disconnect device, if provided in or as part of the product, shall disconnect both poles simultaneously
 - interconnecting power circuits of different products cause no electrical hazards
- A sufficient dimensioning of the power cable wires must be selected – according to the maximum electrical specifications on the product label – as stipulated by EN62368-1 or VDE0100 or EN60204 or UL61010-1 regulations.

For the General Safety Instruction in German or French, visit Kontron's product web page > Downloads > Manuals > General Safety Instructions.

2.2. Instructions générales de sécurité

Veillez lire attentivement ce passage et prendre bonne note des instructions, qui ont été compilées pour votre sécurité et pour assurer une application conforme aux réglementations prévues. Le non-respect des consignes de sécurité générales suivantes peut entraîner des blessures pour l'utilisateur et/ou des dommages pour le produit. En cas de non-respect des consignes, Kontron Europe est exonéré de la responsabilité en cas d'accident, ceci s'applique également pendant la période de garantie.

Le produit a été construit et testé conformément aux exigences de sécurité de base pour les applications basse tension (DBT) et a quitté le fabricant dans un état impeccable en matière de sécurité. Pour maintenir cet état et pour garantir également un fonctionnement sûr, l'opérateur doit non seulement respecter les conditions d'utilisation correctes du produit, mais aussi les consignes de sécurité générales suivantes :

- Le produit doit être utilisé conformément à la documentation du produit, dans laquelle sont décrites les instructions de sécurité pour le produit et pour l'opérateur. Celles-ci contiennent des directives pour la mise en place, l'installation et le montage, la maintenance, le transport ou le stockage.
- L'installation électrique sur place doit répondre aux exigences des réglementations locales spécifiques du pays.
- Si un câble d'alimentation est fourni avec le produit, seul ce câble doit être utilisé. N'utilisez pas de rallonge pour connecter le produit.
- Afin de garantir une circulation d'air suffisante pour refroidir le produit, veuillez vous assurer que les ouvertures de ventilation ne sont pas couvertes ou obstruées. Si un élément filtrant est fourni, celui-ci doit être nettoyé régulièrement. Ne placez pas le produit à proximité de sources de chaleur ou d'endroits humides. Veillez à ce que le produit soit bien ventilé.
- Ne connectez le produit qu'à une alimentation externe fournissant le type de tension (AC ou DC) et la puissance d'entrée (courant max.) spécifiés sur le Label Produit Kontron et répondant aux exigences de la source d'alimentation limitée (LPS) et de la source d'alimentation (PS2) de la norme UL/IEC 62368-1.
- Seuls les produits ou les pièces qui répondent aux exigences de la source d'alimentation (PS1) de la norme UL/IEC 62368-1 peuvent être connectés aux interfaces (E/S) disponibles du produit.
- Avant d'ouvrir le produit, assurez-vous qu'il est bien débranché du secteur.
- Le fait d'éteindre le produit par son bouton de mise en marche ne le déconnecte pas du secteur. Une déconnexion complète n'est possible que si le câble d'alimentation est retiré de la prise murale ou du produit. Veillez à ce que l'accès soit libre et facile pour permettre la déconnexion.
- Le produit ne peut être ouvert que pour l'insertion ou le retrait de cartes supplémentaires (selon la configuration du produit). Cette opération ne peut être effectuée que par des opérateurs qualifiés.

- › Si des extensions sont effectuées, les points suivants doivent être respectés :
 - › toutes les réglementations légales en vigueur et toutes les données techniques sont respectées
 - › la consommation électrique d'une carte supplémentaire ne dépasse pas les limites spécifiées
 - › la consommation actuelle du produit ne dépasse pas la valeur indiquée sur l'étiquette du produit.
- › Seuls les accessoires d'origine approuvés par Kontron Europe peuvent être utilisés.
- › Veuillez noter que la sécurité des opérations n'est plus possible lorsque l'une des conditions suivantes s'applique.
 - › le produit présente des dommages visibles ou
 - › le produit ne fonctionne plus. Dans ce cas, le produit doit être éteint et il faut s'assurer que le produit ne puisse plus être utilisé.
- › La manipulation et le fonctionnement du produit ne sont autorisés que pour le personnel formé dans un lieu de travail dont l'accès est contrôlé.
- › ATTENTION: Risque d'explosion en cas de remplacement incorrect de la pile au lithium (court-circuit, inversion de polarité, mauvais type de pile au lithium). Éliminez les piles au lithium usagées conformément aux instructions du fabricant.
- › Ce produit n'est pas adapté à une utilisation dans des endroits où des enfants sont susceptibles d'être présents
- › Instructions de sécurité supplémentaires pour les circuits d'alimentation en courant continu
- › Pour garantir un fonctionnement sûr, veuillez observer ce qui suit:
 - › l'alimentation électrique externe en courant continu doit répondre aux critères des LPS et PS2 (UL/IEC 62368-1)
 - › aucun câble ou pièce non isolée dans les circuits électriques ayant une tension ou une puissance dangereuse ne doit être touché directement ou indirectement
 - › une connexion à la terre fonctionnelle fiable est fournie
 - › un dispositif de déconnexion approprié et facilement accessible est utilisé dans l'application (par exemple, un dispositif de protection contre les surintensités), si le produit lui-même n'est pas en mesure d'être déconnecté.
 - › un dispositif de déconnexion, s'il est prévu dans le produit ou s'il en fait partie, doit déconnecter les deux pôles simultanément
 - › l'interconnexion des circuits électriques de différents produits ne présente aucun risque électrique
- › Un dimensionnement suffisant des fils du câble d'alimentation doit être choisi - en fonction des spécifications électriques maximales figurant sur l'étiquette du produit - comme stipulé par les réglementations EN62368-1 ou VDE0100 ou EN60204 ou UL61010-1.

2.3. Electrostatic Discharge (ESD)

A sudden discharge of electrostatic electricity can destroy static-sensitive devices or micro-circuitry. Therefore, proper packaging and grounding techniques are necessary precautions to prevent damage.

Always take the following precautions:



ESD Sensitive Device!

Keep electrostatic sensitive parts in their containers until they arrive at the ESD-safe workplace. Always be properly grounded when touching a sensitive board, component, or assembly.

For more Information, see the Special Handling and Unpacking Instruction within this user guide and Chapter 2.4: Grounding Methods.

2.4. Grounding Methods

The following measures help to avoid electrostatic damage to the device:

- › Cover workstations with approved antistatic material. Always wear a wrist strap connected to the workplace, as well as properly grounded tools and equipment.
- › Use antistatic mats, heel straps, or air ionizers for more protection.
- › Always handle electrostatically sensitive components by their edge or by their casing.
- › Avoid contact with pins, leads, or circuitry.
- › Switch off power and input signals before inserting and removing connectors or connecting test equipment.
- › Keep the work area free of non-conductive materials such as ordinary plastic assembly aids and styrofoam.
- › Use field service tools such as cutters, screwdrivers, and vacuum cleaners that are conductive.
- › Always place drives and boards with the PCB-assembly-side down on the foam.

2.5. Instructions for Lithium Battery

The product is equipped with a Kontron specified RTC lithium battery. The RTC lithium battery may over time need to be replaced. Note that there is a risk of explosion if the lithium battery is replaced incorrectly (short-circuited, reverse-poled, wrong lithium battery type).

Replace the RTC lithium battery, only with the same type of lithium battery or with a Kontron recommended RTC lithium battery type, see Table 3: Accessories and Spare Parts.

For instructions on how to replace the RTC Lithium battery, see Chapter 14/: Maintenance and Prevention. After removing the lithium battery, dispose of the lithium battery according to the regulations within your region

⚠ CAUTION

Danger of Explosion if lithium battery incorrectly placed!

- › Replace only with the same or equivalent type recommended by the manufacturer
- › Dispose of used batteries according to the manufacturer's instructions

ATTENTION- Risque d'explosion avec l'échange inadéquat de la batterie!

- › Remplacement seulement par le même ou un type équivalent recommandé par le producteur
- › L'évacuation des batteries usagées conformément à des indications du fabricant

VORSICHT- Explosionsgefahr bei unsachgemäßem Austausch der Batterie!

- › Ersatz nur durch denselben oder einen vom Hersteller empfohlenen gleichwertigen Typ
- › Entsorgung gebrauchter Batterien nach Angaben des Herstellers



Do not dispose of lithium batteries in general trash collection. Dispose of the lithium battery according to the local regulations dealing with the disposal of these special materials, (e.g. to the collecting points for disposal of batteries).

2.6. Thermal Conditions

The product is passively cooled using a heatsink. There is a risk of burns or injury when touching the heatsink.

Hot Surface

The heatsink can get very hot. To avoid burns and personal injury when handling the heatsink:

- › Do not touch while in operation
- › Allow to cool before handling
- › Wear protective gloves

Surface chaude

Le dissipateur thermique peut devenir très chaud. Pour éviter les brûlures et les blessures lors de la manipulation du dissipateur thermique :

- › Ne pas toucher pendant le fonctionnement
- › Laisser refroidir avant la manipulation
- › Portez des gants de protection

Heiße Oberfläche

Der Kühlkörper kann sehr heiß werden. Um Verbrennungen und Verletzungen beim Umgang mit dem Kühlkörper zu vermeiden:

- › Während des Betriebs nicht berühren
 - › Vor der Handhabung abkühlen lassen
 - › Schutzhandschuhe tragen
-



3/ Shipment and Unpacking

3.1. Packaging

The KBox A-251 is packaged together with all parts, in a product specific cardboard package designed to provide adequate protection and absorb shock.

3.2. Unpacking

To unpack the product, perform the following:

1. Remove packaging.
2. Do not discard the original packaging. Keep the original packaging for future transportation or storage.
3. Check the delivery for completeness by comparing the delivery with the original order.
4. Keep the associated paperwork. It contains important information for handling the product.
5. Check the product for visible shipping damage.

If you notice shipping damage or inconsistencies between the contents and the original order, contact your dealer.

3.3. Scope of Delivery

The scope of delivery describes the parts included in your delivery. Check that the delivery is complete and contains the items listed. If damaged or missing items are discovered, contact your dealer.

Table 1: Scope of Delivery- KBox A-251 (24 VDC variant)

Product	Description
KBox A-251	KBox A-251 with hardware configurations (processor and system expansion)
24 VDC Power Connector	3-pin Phoenix power (1.5/ 3-STF-3.5) mating connector
DIN Rail Clamp	DIN Rail clamp (or Rugged DIN Rail Clamp if ordered)
Antenna	Wi-Fi and LTE antenna (only included in the delivery if configured with Wi-Fi and/or cellular LTE)
General Safety Instructions	General safety instructions when operating or handling IT equipment

Table 2: Scope of Delivery - KBox A-251 (12 VDC variant)

Product	Description
KBox A-251	KBox A-251- with hardware configurations (processor and system expansion)
Power Supply	240/100 VAC to 12 VDC PSU Power cable with plug for your region
DIN Rail Clamp	DIN Rail clamp (or Rugged DIN Rail Clamp if ordered)
Antenna	Wi-Fi and LTE antenna (only included in the delivery if configured with Wi-Fi and/or cellular LTE)
General Safety Instructions	General safety instructions when operating or handling IT equipment

3.4. Accessories and Spare Parts

Table 3: Accessories and Spare Parts

Part Number	Part	Description
1074-8461	Power connector	3-pin mating Phoenix power connector (1.5/ 3-STF-3.5)
1070-4091	AC/DC Power Supply Unit (PSU) 12 V	External AC/DC PSU 12 VDC, 60 W at 40°C, with 1.0 m cable and DC-connector (Ø 5.5 mm/Ø 2.1 mm)
1075-4825	AC/DC Power Supply Unit (PSU) 24 V	External AC/DC PSU 24 VDC, 60 W at 40°C, with 1.5 m cable and wire end ferrules (1.0 mm ²)
840-0059	Power cable EU	Power cable AC mains (2 m) to external Europe plug
840-0115	Power cable UK	Power cable AC mains (1.8 m) to external UK plug
0-0064-4317	Power cable US	Power cable AC mains (2 m) to external USA plug
9-5000-1155	KIT DIN-RAIL	DIN-RAIL adapter incl. screws
9-5000-1154	KIT Rugged DIN-RAIL	Rugged DIN-RAIL adapter incl. screws
1068-4995	BR2032 3V Lithium battery	BR2032 3V lithium battery with cable
1080-5909	Automotive Battery Module Set 	SET for KBox-A-251_Automotive Battery Spare part or accessory including: BR2450 3V lithium battery, battery extension cable, mounting plate, three nuts and adhesive pads.
Manufacturer: SparkLan Article Number: R3410A10050	Wi-Fi Antenna 	Product Name: AD-501AX Type: Dipole Wi-Fi 6, including 6E and BT Connector: RP-SMA (male) Frequency: 2.4 GHz/5 GHz/6 GHz Peak gain: 3.7 dBi/5 dBi/5 dBi L x W x T: 162 mm x 22 mm x 6.8 mm Hinge: 0° to 90° Impedance: 50 ohms
Manufacturer: 2J antenna conceptor Article Number: 2JW0924-C952B	Cellular LTE Antenna 	Type: 4G LTE Connector: SMA (male) Pattern: Omni - directional Standards: 2 G / 3 G / 4 G Frequency: 698-960 MHz 1710-2170 MHz 2500-2700 MHz Peak Gain: 0.6 dBi / 2.6 dBi / 2.3 dBi L x W x T: 170 mm x 18 mm x 10 mm Hinge: 0° to 90° Impedance: 50 ohms

3.5. Product Identification Type Label

The KBox A-251 is part of Kontron’s A-Series DIN Rail embedded Box PCs intended for control cabinet applications. The type label is used for product identification and includes important product specific information such as the electrical specification and the compliance of the ordered product variant.

Table 4: Product Identification based on AML/ADN Processor Platform

System Type	Model	Marketing Name	Description
KBox A	KBox A-251	KBox A-251-AML/ADN	Corresponds to hardware configurations based on the different processor platform with the 2.5”-SBC form factor.

Figure 2: Type Label 24 VDC and 12 VDC Variants Examples

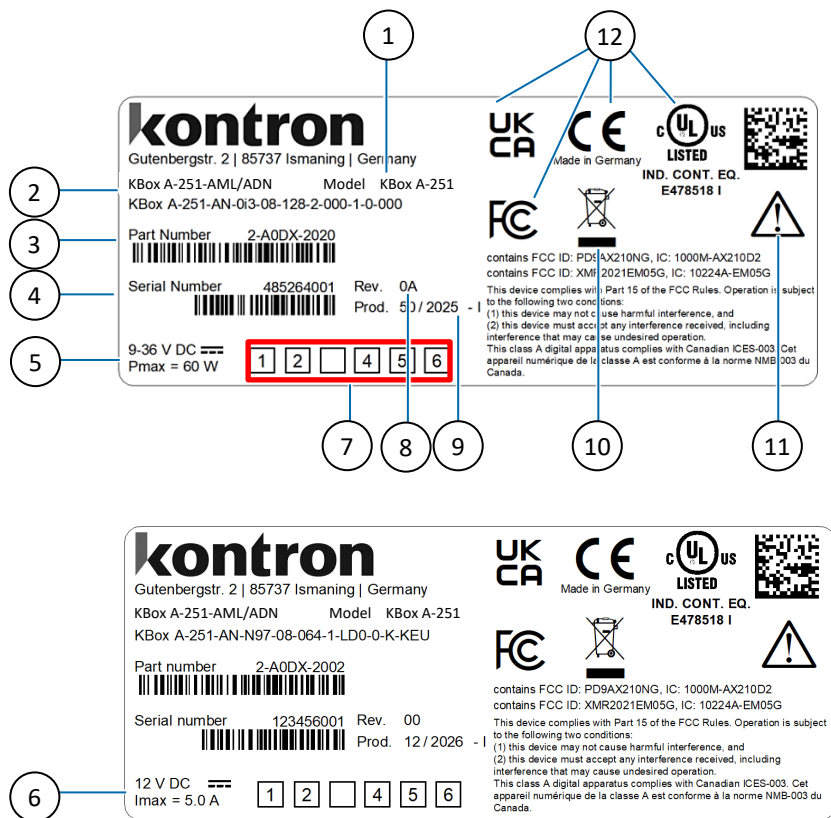

- | | |
|-----------------------------------|-------------------------|
| 1 Model name | 7 For Internal use |
| 2 Marketing name | 8 Revision |
| 3 Part Number with bar code | 9 Production date |
| 4 Serial Number and bar code | 10 Dispose of correctly |
| 5 Electrical specification 24 VDC | 11 Observe warnings |
| 6 Electrical Specification 12 VDC | 12 Compliance symbols |

4/Product Features

4.1. Front Panel

The front panel features I/O interfaces, status LEDs, functional earth bolt and power connection (24 VDC or 12 VDC).

Figure 3: Front Panel

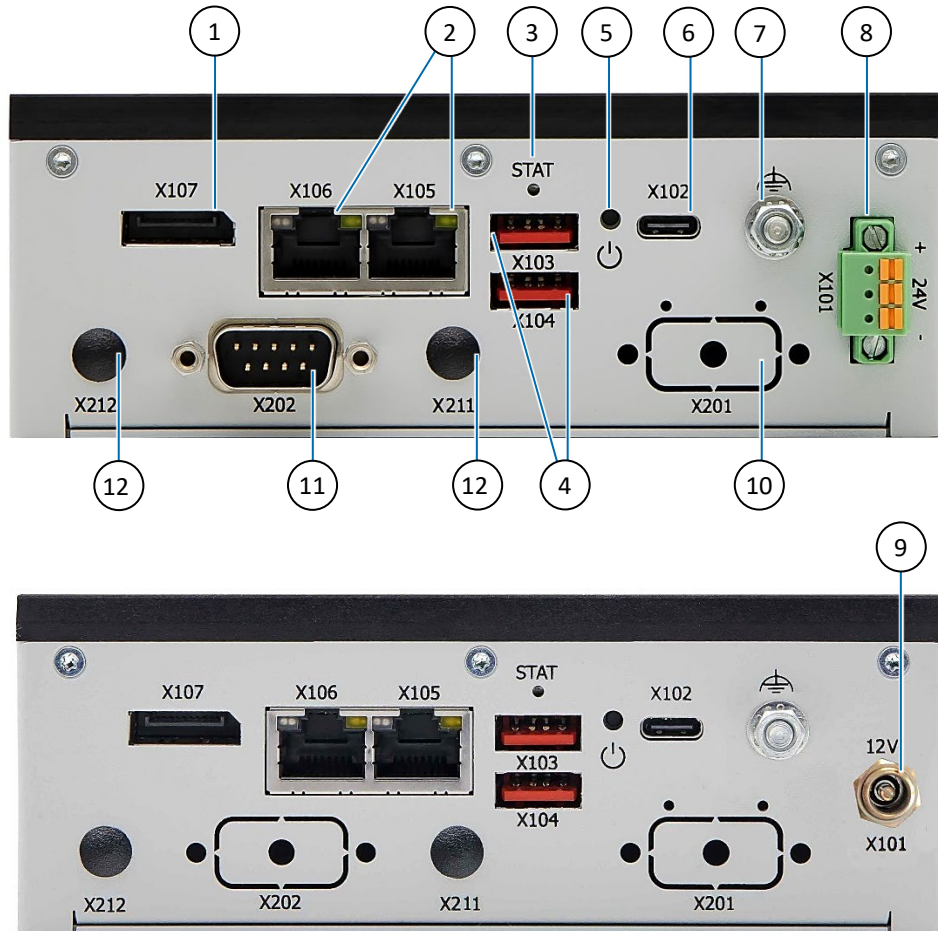

- | | | | |
|---|-----------------------------|----|---|
| 1 | DisplayPort (X107) | 7 | Functional earth bolt |
| 2 | 2x 2.5 GBE LAN (X105/106) | 8 | Power IN 24 VDC connector (X101) |
| 3 | Power LED (STAT) | 9 | Power IN 12 VDC connector (X101) |
| 4 | 2x USB 3.2 Gen 2 (X103/104) | 10 | Breakout (X201) Serial Port RS232 or SIM card for cellular option |
| 5 | Power Button | 11 | Breakout (X202) Serial Port RS232 |
| 6 | 1x USB-C (X102) | 12 | Breakouts (X211/X212) for Antenna |

4.1.1. Power IN 24 VDC (X101) (default)

The Power IN 3-pin 24 VDC connector (X101) connects to an external 24 VDC power supply that meets the product's electrical specification displayed on the product's type label and within this user guide, and the power consumption, power limitation and power protection requirements specified in this user guide. The Power IN 24 VDC connector includes reverse polarity protection with a tolerance of Urev_max = -38 VDC, to prevent damage in the event that the DC supply is connected with incorrect polarity.

The mating power connector (3-pin, 1.5/ 3-STF-3.5) is delivered with the product, to be wired suitably by the user as described in Chapter 9.2.1: Wiring the Power IN Connector. For the pin assignment of the Power IN connector and the mating connector, see Chapter 12.1: Power IN 24 VDC (X101)(default).

External Power Supply

⚠ CAUTION

Only connect to an external 24 VDC power supply that meets the product's electrical specification displayed on the product type label, and the power consumption, power limitation and power protection requirements specified in this user guide.

4.1.2. Power IN 12 VDC (X101) (option)

The Power IN 12 VDC connector (X101) connects to an external 12 VDC power supply that meets the product's electrical specification displayed on the product's type label, and the power consumption, power limitation and power protection requirements specified in this user guide. The Power IN 12 VDC connector does not include reverse polarity protection. To prevent damage, the DC supply must be connected with the correct polarity.

The mating Power connector must be provided by the user. For the pin assignment of the Power IN connector and mating connector, see Chapter 12.2: Power IN 12 VDC Connector (X101) (option).

External Power Supply

⚠ CAUTION

Only connect to an external 12 VDC power supply that meets the product's electrical specification displayed on the product type label, and the power consumption, power limitation and power protection requirements specified in this user guide.

No Reverse Polarity Protection

⚠ CAUTION

The Power IN 12 VDC connector does not include reverse polarity protection. To prevent damage, the DC supply must be connected with the correct polarity.

4.1.3. Functional Earth Bolt

The functional earth bolt connects to the internal chassis ground. There is no isolation between the Power IN GND (-) and the system chassis. Always include a functional earth connection.

⚠ CAUTION

Functional Earth

Always include a functional earth connection!

4.1.4. Power Button

The power button switches on or switches off the product. Switched on by pressing the power button once and switched off by pressing the power button again to perform an orderly shutdown. Pressing the power button for more than four seconds switches the product from the 'on' to 'off' state and performs a forced shutdown.

4.1.5. State LED (STAT)

The state LED indicates the product's current state.

Table 5: State LED Description

STAT LED (green)	Description
On (green)	Power on (fully operational)
Blinking (green)	Sleeping/suspended
Off	Power off

4.1.6. USB-C Port (X102)

The USB-C port (X102) supports USB 3.2 Gen 2 or Gen 1 depending on the processor and DP Alternate Mode to carry video, audio, data & power (PD 5 V/3 A) over a single port, to enable the direct connection of a monitor.

For the pin assignment of the USB-C Port, see Chapter 12.3: USB-C Port (X102).



The USB-C DP-Alt-Mode port can power a device with 5 V and 3 A or connect a display as an additional DP port



USB -C Type

- › Intel Atom® x7000RE series of processors support USB-C 3.2 Gen 1
- › Intel® Core™ i3 N-series & Intel® Processor N-series support USB-C 3.2 Gen 2

4.1.7. USB 3.2 Gen 2 Ports (X103, X104)

The two USB 3.2 ports (X103 and X104) support USB 3.2 Gen 2 compatible devices.

For the pin assignment of the USB 3.2 Gen 2 ports, see Chapter 12.4: USB 3.2 Gen 2 Ports (X103, X104).



The USB 3.2 Gen 2 ports are backwards compatible with USB 3.2 Gen 1 and USB 2.0 ports.



To achieve the specified performance for USB 3.2 Gen 2 performance use cables that complies with the USB 3.2 standard.

4.1.8. Ethernet 2.5 GbE Ports (X105, X106)

The Ethernet ports (X105 and X106) each support one channel of 10/100/1000/2500 Mbit Ethernet. To achieve the specified Ethernet port performance, Category 5 twisted pair cables must be used with 10/100 Mbit and Category 5E, 6 or 6E with 1 GbE/2.5 GbE networks.

For the pin assignment of the Ethernet LAN ports and information regarding the Ethernet status LEDs, see Chapter 12.5: LAN Connectors (X105, X106).



To achieve the specified performance of the Ethernet port, Category 5 twisted pair cables must be used with 10/100 MByte and Category 5E, 6 or 6E with 1 GbE/2.5 GbE networks.

4.1.9. DisplayPorts (X107)

The DisplayPort (DP) (X107) is a standard DP++ port, supporting a maximum resolution of 4096 x 2160 @ 60 Hz.

For the pin assignment of the DP connector, see Chapter 12.6: DisplayPort Connectors (X107).

4.1.10. Serial Port (X202)

The Serial Port (X202) supports RS232 with RX/TX support and no handshaking.

For the pin assignment of the Serial Port RS232, see Chapter 12.1.7: Serial Port Connectors (X202) and (X201 option).



The front panel connector (X202) is the default Serial Port RS232. The front panel connector (X201) may be implemented as a second Serial Port RS232.

4.1.11. Serial Port (X201) (option)

The breakout (X201) may be implemented as an optional Serial Port supporting RS232 with RX/TX support and no handshaking.

For the pin assignment of the Serial Port RS232 port, see Chapter 12.1.7: Serial Port Connectors (X202) and (X201 option).



The front panel connector (X201) may be implemented as an optional Serial Port supporting RS232 or an optional SIM slot for cellular LTE networks.

4.1.12. SIM Slot (X201) (option)

The breakout (X201) may be implemented as an optional SIM card slot for a standard SIM card (15 mm x 25 mm) for use in combination with the cellular LTE module only and not available for storage.

NOTICE

Switch off to Insert/Extract SIM

Only insert or extract the SIM cards if the product is switched off properly.



The front panel connector (X201) may be implemented as an optional Serial Port supporting RS232 or an optional SIM slot for cellular LTE networks.



A cellular network SIM card is not part of the delivery and must be provided by the user, to support the required network.

4.1.13. Antenna (X211, X212) (option)

The two antenna breakouts (X211 and X212) support Wi-Fi and/or cellular LTE depending on the internal configuration. If Wi-Fi and/or cellular LTE are not implemented the openings for (X211, X212) are covered.

For information regarding the Wi-Fi or cellular LTE technical specification see Table 9: Wi-Fi Module Specification and Table 10: Cellular LTE Module Specification.

Wi-Fi and Cellular LTE use different antenna types that are not electrically compatible and not interchangeable. Before connecting to the product's antenna connectors ensure that you are connecting the correct antenna type, see Figure 4. Users are responsible for connecting the correct type of antenna to the product's antenna connectors.

Figure 4: Wi-Fi and Cellular LTE Connectors and Antenna Type

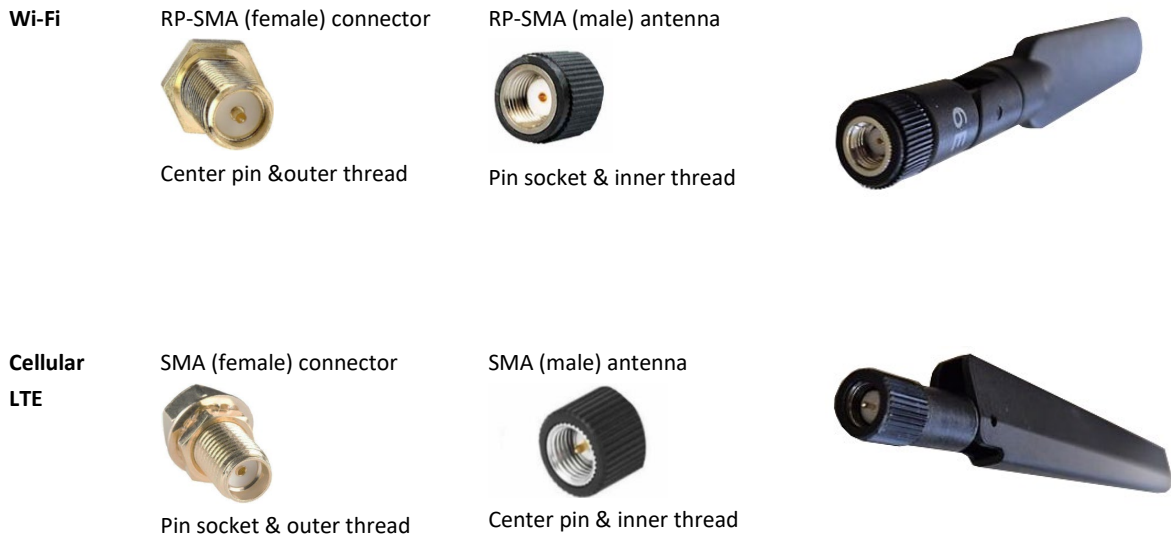

The position of the antenna may affect performance. Do not place the antenna close to a noise source that may cause interference. For more information regarding the delivered antenna and the antenna requirements, see Chapter 12.9: Antenna Connectors (X211, X212).

All the required antennas are delivered with the product. Kontron recommends that users only connect the delivered reference antenna chosen to meet product requirements. For more information regarding the reference antenna and the antenna requirements, see Chapter 12.9: Antenna Connectors (X211, X212) and Table 3: Accessories and Spare Parts.

Antenna RF exposure

To avoid RF antenna exposure:

CAUTION

- Avoid placing the antenna near people, minimum distance 20 cm.
- Avoid pointing the antenna at people.
- Keep a safe distance from the antenna especially when transmitting.

NOTICE

RP-SMA and SMA Antenna are not Interchangeable!

RP-SMA and SMA connectors and antenna are not electrically compatible. Incorrect connection may result in an insufficient connection or destroy the center pin.



Kontron recommends the use of Kontron's reference antenna included in the delivery and chosen to meet RF performance requirements, and to support a nominal impedance of 50 ohms, see Table 3: Accessories and Spare Parts.

4.2. Left Side

The left side features a system expansion I/O door supporting various interface options. For more information regarding the different system expansion I/O door plate options, see Chapter 5.5: System Expansion I/O Door.

Figure 5: Left Side

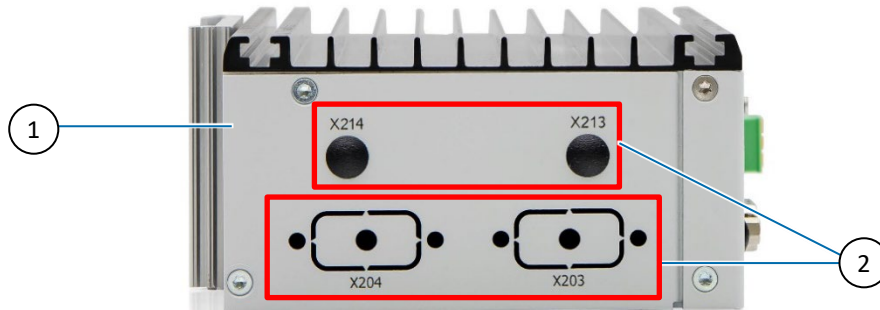

- 1 System expansion I/O door plate (four different plates are available)
- 2 System expansion I/O door connector breakouts and openings for antenna

4.3. Right Side

The right side features the product’s type label with the electrical specification.

Figure 6: Right Side



4.4. Rear Side

The rear side features two-threaded openings used to mount the reversible DIN Rail clamp (50 mm x 50 mm). The product is delivered with the DIN Rail clamp installed on the rear side.

Figure 7: Rear Side



1 DIN Rail clamp

2 2x M4x6 screws

4.5. Top Side

The top side is a heatsink and can become hot to touch.

Figure 8: Top Side

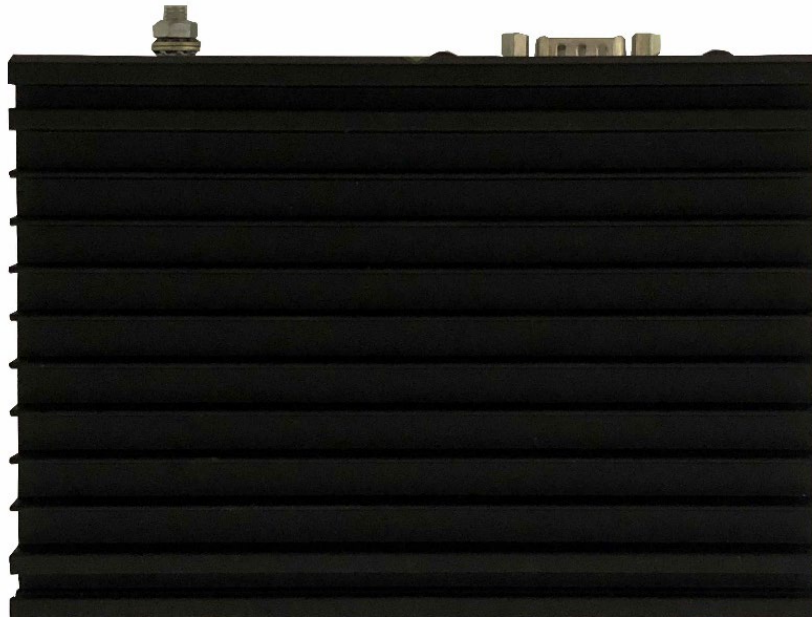

Hot Surface

Heatsinks can get very hot. To avoid burns and personal injury when handling the heatsink:



- › Do not touch while in operation
- › Allow to cool before handling
- › Wear protective gloves

4.6. Bottom Side

The bottom side features a cover plate with two screws. Removing the cover plate accesses internal components.

Figure 9: Bottom Side

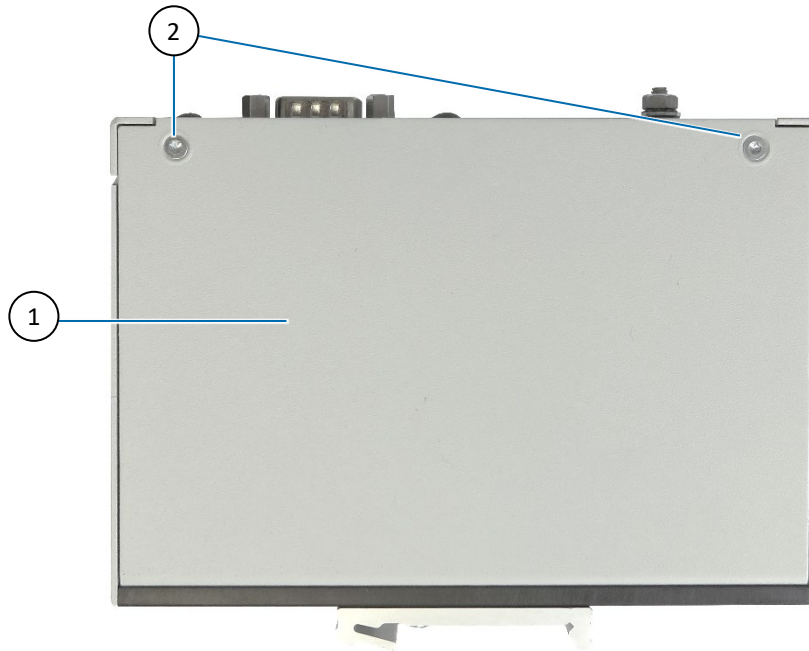

1 Cover plate

2 2x Screws

4.7. Internal 2.5"-SBC-Board Features

Protection Label

NOTICE

The product is factory configured to meet customer requirements and then sealed with a protection label. Opening the product invalidates the warranty and may cause damage to internal components. For more information, refer to Chapter 15.1: Returning Defective Merchandise.

The KBox A-251 includes an internal 2.5"-Single Board Computer (SBC) board. The KBox A-251 variant depends on the installed 2.5"-SBC Board type and processor.

For more information on the installed 2.5"-SBC-board and processor, visit the [Single Board Computer 2.5" \(pITX\)](#) website and access the user guide for your 2.5"-SBC-board and processor family.

4.7.1. 2.5"-SBC-AML/ADN On-board Components

The KBox A-251-AML/ADN includes the 2.5"-SBC-AML/ADN board with Intel Atom® x7000RE, Intel® Core™ i3 N or Intel® Processor N-Series of processors. The following figures describe the connectors and headers.

Figure 10: 2.5"-SBC-AML/ADN - Top Side

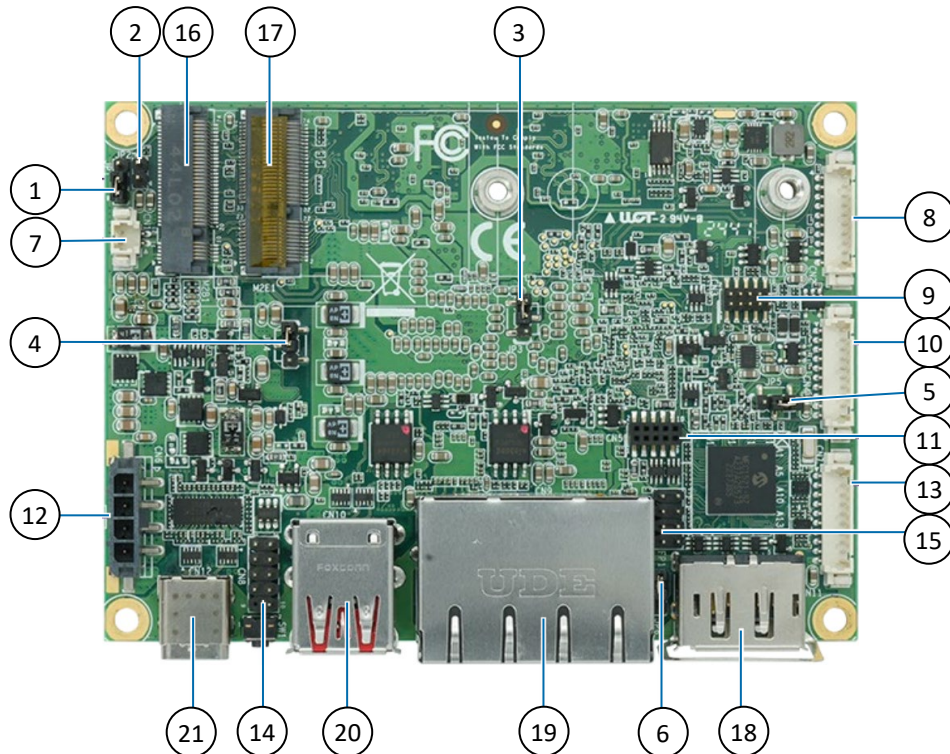

- | | | | |
|----|---|----|--|
| 1 | Flash Descriptor Security Override Selection Jumper (JP1) | 11 | P80 Holder |
| 2 | Clear CMOS Selection Jumper (JP2) | 12 | DC Power Input Connector |
| 3 | M.2 Key B Selection Jumper (JP3) | 13 | DIO Connector |
| 4 | USB Power Selection Jumper (JP4) | 14 | USB 2.0 Port 3 & 4 Header |
| 5 | eDP Panel Power Selection Jumper (JP5) | 15 | Front Panel 1 Header |
| 6 | AT /ATX Power Mode Selection Jumper (JP6) | 16 | M.2 Key B 2242/3042/3052/2280 Socket |
| 7 | RTC Power Input Header | 17 | M.2 Key E 2230 Socket |
| 8 | RS232 COM1 Connector | 18 | DisplayPort (X107) |
| 9 | SPI 10-Pins Header | 19 | 2x Ethernet 2.5 GBE ports (X106, x107) |
| 10 | RS232 COM2 Connector | 20 | 2x USB 3.2 Gen 2 ports (X103, x104) |
| | | 21 | USB-C Port (X102) |



USB -C Port (X102) Information

- Intel Atom® x7000RE series of processors support USB-C 3.2 Gen 1
- Intel® Core™ i3 N-series & Intel® Processor N-series support USB-C 3.2 Gen 2

Figure 11: 2.5"-SBC-AML/ADN - Bottom Side

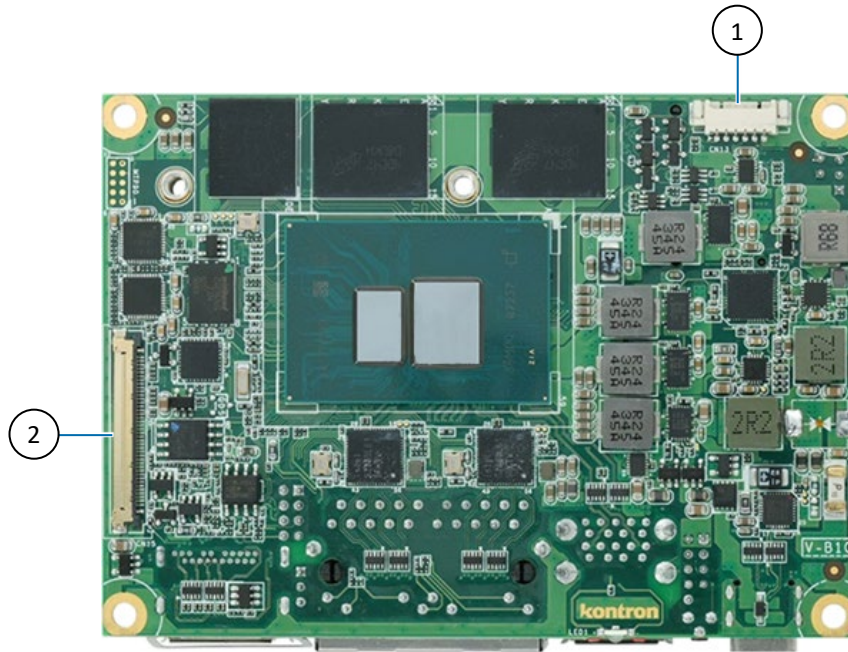

- 1 SIM Card connector (for M2B1)
- 2 eDP Connector



For more 2.5"-SBC-AML/ADN information visit the [2.5"-SBC-AML/ADN](#) website and access the user guide.

4.7.2. 2.5"-SBC-AML/ADN Expansion Sockets

The internal 2.5"-SBC board supports M.2 sockets. The quantity and type of M.2 socket may differ between 2.5"-SBC boards.

Table 6: 2.5"-SBC Board M.2 Expansion Sockets

2.5"-SBC-Board	M.2 Sockets	Description
2.5"-SBC-AML/ADN	M.2 2230 Key E	Supports PCIe x1, USB 2.0, UART, PCM and/or CNVi signals.
		Used to integrate Wi-Fi/Bluetooth.
	M.2 2242/3042/3052/2280 Key B	Supports PCIe x2, USB 2.0, SATA 3.0 signals and UIM signals connected to the SIM card wafer.
		Used to integrate storage, cellular LTE, or a system expansion I/O door option: dual CAN, EtherCAT, dual Serial Port (RS232) or dual LAN.



For more information on the expansion sockets for your 2.5"-SBC-board and processor, visit the [Single Board Computer 2.5" \(pITX\)](#) website and access the user guide for your 2.5"-SBC-board and processor family.

4.7.3. Maximum Processor Power and Temperature

The internal 2.5"-SBC board's Intel® processor provide internal thermal monitoring with a temperature sensor. To allow for optimal operation and long-term reliability, the processor must operate in the specified temperature range. To avoid overheating the processor performs automatic thermal management, to keep the processor temperature below the highest value of the temperature range.

Table 7: Processor TDP and Maximum Temperature Values

2.5"-SBC-Board & Processors	Description (Core, Cache, Max. Turbo Frequency)	Power	Temperature	
		TDP	DTR	T-Junction
2.5"-SBC-AML/ADN				
Intel® N97	Quad-Core, 6M Cache, 3.6 GHz	12 W	+/-70°C (158°F)	105°C (221°F)
Intel® Core™ i3-N305	Octa-Core, 6M Cache, 3.8 GHz	15 W	+/-70°C (158°F)	105°C (221°F)
Intel Atom® X7211RE	Dual-Core, 6M Cache, 3.2 GHz	6 W	+/- 110°C (230°F)	105°C (221°F)
Intel Atom® X7433RE	Quad-Core, 6M Cache, 3.4 GHz	9 W	+/- 110°C (230°F)	105°C (221°F)
Intel Atom® X7835RE	Octa-Core, 6M Cache, 3.6 GHz	12 W	+/- 110°C (230°F)	105°C (221°F)



Dynamic Temperature Range (DTR) defines the maximum temperature range during operation starting from boot time temperature and within the T-Junction limits. For further DTR information for your processor or a higher DTR-value, contact [Kontron Support](#).



T-Junction is the maximum junction temperature allowed at the processor die.

4.7.4. RTC Lithium Battery

The default RTC lithium battery is BR2032, with the option for an automotive RTC lithium battery module with BR2450 with a longer lifetime (lifetime > 10 years).

An empty RTC lithium battery BIOS does not affect the BIOS settings. However, the system time and date are affected when the RTC battery is empty and must be reconfigured after replacing the battery.

The RTC lithium battery may over time need to be replaced. For instruction on how to replace the RTC Lithium battery, see Chapter 14/Maintenance and Prevention.

Note that there is a risk of explosion if the lithium battery is replaced incorrectly (short-circuited, reverse-poled, wrong lithium battery type), for safety and disposal information see Chapter 2.5: Instructions for Lithium Battery.

Figure 12: RTC Lithium Battery Installed



1 RTC lithium battery BR2032
(default)

2 Automotive RTC lithium battery module
with BR2450

5/System Expansion

The KBox A-251 supports system expansion in the form of internal storage, Wi-Fi and/or cellular LTE modules and system expansion I/O door options.

5.1. Before Expanding

The expansion options are factory configured and are not accessible in the field. Return the product to Kontron to replace or install internal components, see Chapter 15.1: Returning Defective Merchandise.

NOTICE

Protection label

The product is factory configured to meet customer requirements and then sealed with a protection label. Opening the product invalidates the warranty.



Storage, Cellular LTE, dual CAN, EtherCAT, dual Serial Port (RS232) or dual LAN are mutually exclusive as each requires the use of the M.2 Key B socket and are mutually exclusive.

5.2. Storage Expansion

The M.2 2280 SSD module is factory installed. Return the product to Kontron, for replacement or installation of the M.2 SSD module, see Chapter 15.1: Returning Defective Merchandise.

Table 8: Storage SSD Module Specification

Function	Description
Storage	Module: SSD Socket type: M.2 Key B 2242 / 3042 / 3052 / 2280 Density: Up to 2 TByte Interface: SATA III 6Gb/s Type: 3D NAND Flash Features: 3000 P/E Cycles Power Consumption: 1.40 W max.



Storage, Cellular LTE, dual CAN, EtherCAT, dual Serial Port (RS232) or dual LAN are mutually exclusive as each requires the use of the M.2 Key B socket and are mutually exclusive.

5.3. Wireless Expansion Options

5.3.1. Wi-Fi

The Wi-Fi expansion option is factory installed. Return the product to Kontron, for replacement of the module, see Chapter 15.1: Returning Defective Merchandise.

The M.2 Wi-Fi module populates the M.2 key E socket and as a result this socket is no longer available for other expansion options. Configuration of the Wi-Fi M.2 Key E module is always possible and independent of other Kontron expansion options.

The antenna position may affect the performance. Do not place the antenna close to a noise source that may cause interference. Kontron recommends the use of Kontron's reference antenna chosen to meet RF performance

requirements and supports a nominal impedance of 50 ohms. The reference antennas are included in the delivery and available as an accessory, see Table 3: Accessories and Spare Parts.

Table 9: Wi-Fi Module Specification

Function	Reference Modules Description
Wi-Fi/Bluetooth® module	Module: Wi-Fi 6E AX210 Connector: 2x RP-SMA (female) with center pin & outer thread Channels: 2x2 160 MHz Bandwidth: 2.4 Gbps Socket Type: M.2 Key E 2230 IEEE Standards: Wi-Fi: 802.11a/b/g/n/ac R2/ax R2(Pre-Standard) Bluetooth standard: V5.3 Interface: PCIe x1 (Wi-Fi) and USB 2.0 (Bluetooth®) MIMO Support: 2x2 MIMO Security levels: WPA, WPA2, WPA3 Power Consumption: 2.98 W max. (@Worst case TDP Wi-Fi 2.88 W / BT 0.1 W)

Antenna RF exposure

To avoid RF antenna exposure:

⚠ CAUTION

- Avoid placing the antenna near people, minimum distance 20 cm.
- Avoid pointing the antenna at people.
- Keep a safe distance from the antenna especially when transmitting.

NOTICE

RP-SMA and SMA Antenna are not Interchangeable!

RP-SMA and SMA connectors and antenna are not electrically compatible. Incorrect connection may result in an insufficient connection or destroy the center pin.



Kontron recommends the use of Kontron's reference antenna included in the delivery and chosen to meet RF performance requirements, and to support a nominal impedance of 50 ohms, see Table 3: Accessories and Spare Parts.

5.3.2. Cellular LTE

The Cellular LTE expansion option is factory installed and requires a SIM slot on the front panel (X201). Return the product to Kontron, for replacement of the module, see Chapter 15.1: Returning Defective Merchandise.

The M.2 LTE module populates the M.2 key B socket and as a result this socket is no longer available for other expansion options.

Cellular LTE requires a SIM card that must be provided by the user for the required cellular network and inserted into the SIM slot in the front panel breakout (X201).

The antenna position may affect the performance. Do not place the antenna close to a noise source that may cause interference. Kontron recommends the use of Kontron's reference antenna (included in the delivery). The reference antenna has been chosen to meet RF performance requirements and supports a nominal impedance of 50 ohms, see Table 3: Accessories and Spare Parts.

Table 10: Cellular LTE Module Specification

Function	Reference Module Description
Cellular LTE Module	<p>Module: Quectel EM05-G Series</p> <p>LTE: LTE Cat. 4</p> <p>Connector: 2x SMA (female) with pin socket and inner thread.</p> <p>Data Rate: 150 Mbps download; 50 Mbps upload</p> <p>Socket Type: M.2 Key B 3042</p> <p>Freq. Bands: B1/2/3/4/5/7/8/12/13/14/18/19/20/25/26/28/66/71/38/39/40/41</p> <p>Interface: USB 2.0</p> <p>Power Consumption: 2.5 W max.</p> <p>MIMO Support: Yes</p>

Antenna RF exposure

To avoid RF antenna exposure:

CAUTION

- Avoid placing the antenna near people, minimum distance 20 cm.
- Avoid pointing the antenna at people.
- Keep a safe distance from the antenna especially when transmitting.

NOTICE**RP-SMA and SMA Antenna are not Interchangeable!**

RP-SMA and SMA connectors and antenna are not electrically compatible. Incorrect connection may result in an insufficient connection or destroy the center pin.



Prerequisite for Cellular LTE, is a M.2 key B socket.



Kontron recommends the use of Kontron's reference antenna included in the delivery and chosen to meet RF performance requirements, and to support a nominal impedance of 50 ohms, see Table 3: Accessories and Spare Parts.

5.4. System Expansion I/O Door

The system expansion I/O door expands the product's functionality. The supported system expansion options depend on the available M.2 sockets and on-board connectors on for your 2.5"-SBC-board and processor.



For more information on the M.2 sockets and on-board connectors for your 2.5"-SBC-board and processor, visit the [Single Board Computer 2.5" \(p1TX\)](#) website and access the user guide for your 2.5"-SBC-board and processor family.

The Cellular LTE, dual CAN, EtherCAT, dual Serial Port (RS232) and dual LAN options each required an M.2 Key B sockets and can only be implemented individually but can be used with other expansion options that do not require the use of a M.2 Key B socket, see Table 11: System Expansion I/O Door Combination Overview.



To implement a Cellular LTE, dual CAN, EtherCAT, dual Serial Port (RS232) or dual LAN, the M.2 Key B socket must be free for use.

For an overview of the allowed expansion combinations, see Table 11: System Expansion I/O Door Combination Overview.

Table 11: System Expansion I/O Door Combination Overview

Combination Options	Wi-Fi/BT	LTE	Dual 2.5 GbE	Dual CAN	EtherCAT	Dual Serial Port RS232	Dual Serial Port RSxxx	GPIO/DIO
Wi-Fi/BT®	✓	x	x	x	x	x	x	x
LTE	x	✓	-	-	-	-	x	x
Dual 2.5 GbE	x	-	✓	-	-	-	-	-
Dual CAN	x	-	-	✓	-	-	-	-
EtherCAT	x	-	-	-	✓	-	-	-
Dual Serial Port RS232	x	-	-	-	-	✓	-	-
Dual Serial Port RSxxx	x	x	-	-	-	-	✓	-
DIO/GPIO	x	x	-	-	-	-	-	✓

[✓] option considered

[x] possible additional options

[-] options not available

The four different system expansion I/O door plates support different functionality and connector types. For the functionality and connector numbering of the system expansion I/O door plates 1 to 4 see Table 12: System Expansion I/O Door Plates 1 to 4.

Table 12: System Expansion I/O Door Plates 1 to 4

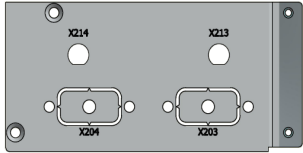
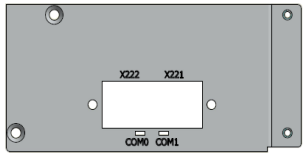
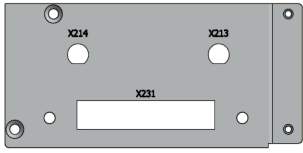
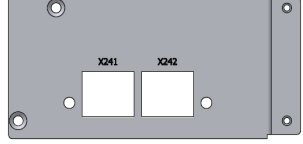
System Expansion I/O Door Plates	Functionality	Connector Number
	Dual Serial Port RS232	X203, X204
	Dual Serial Port RSxxx	X203, X204
	Dual CAN	X203, X204
	Antenna	X213, X214
	EtherCAT	X221, X222
	GPIO/DIO	X231
	Antenna	X213, X214
	Dual LAN	X241, X242

5.4.1. Dual LAN

The system expansion I/O door is factory installed and supports two 2.5 GbE LAN ports.

For the dual LAN pin assignment, see Chapter 12.2.2: Dual LAN Connectors (X241, X242).

Table 13: Dual LAN Module

Function	Description
Dual 2.5 GbE LAN	Two 2.5 GbE LAN ports Two RJ45 Connectors, with speed and activity LEDs Implements the EGPL-22S1-W1-U481 (M.2 2280 Key B module)



To achieve the specified performance of the Ethernet port, Category 5 twisted pair cables must be used with 10/100 MByte and Category 5E, 6 or 6E with 1 GbE/2.5 GbE networks.

5.4.2. Dual CAN

The system expansion I/O door with dual CAN is factory installed and supports two CAN bus 2.0B ports that are both backwards compatible with CAN bus 2.0A and meet the requirements of ISO 11898-1.

For the dual CAN Bus pin assignment, see Chapter 12.2.3: Dual CAN Bus Connectors (X203, X204).

Table 14: Dual CAN Module

Function	Description
Dual CAN	Two CAN Bus 2.0B ports (backwards compatible with CAN bus 2.0A) ISO 11898-1 compliant Baud rates of 10/20/50/100/250/500/800/1000K CAN message acceptance filter and J1939/CAN open high layer protocol Implements the EGPC-B2S1 (M.2 2280 Key B module)

5.4.3. EtherCAT

The system expansion I/O door with EtherCAT is factory installed and supports dual EtherCat ports with Auto Crossover and switching between RX and TX. The connector's green LEDs indicate the link status, and the yellow LEDs indicate the network activity. Check the LED status to confirm an Ethernet connection.

For the EtherCAT pin assignment, see Chapter 12.2.4: EtherCAT Connectors (X221, X222).

Table 15: EtherCAT Module

Function	Description
EtherCAT	Two RJ45 EtherCat ports Auto Crossover and switching between RX and TX. Implements the CIFX M3042100BM-RE/F (M.2 3042 Key B module)

EtherCAT LAN Only

NOTICE

The EtherCAT RJ45 connectors may only be used for LAN. Used for telecommunications is not possible.



For the EtherCat interface use twisted pair cable of category 5 (CAT5) or higher, consisting of four twisted cores and with a maximum transfer rate of 100 MBit/s (CAT5).

5.4.4. Dual Serial Ports (RS232)

The system expansion I/O door with dual Serial Ports is factory installed and supports two RS232 serial ports.

For the dual Serial Port (RS232) pin assignment, see Chapter 12.2.5: Dual Serial Port Connectors RS232 (X203, X204).

Table 16: Dual Serial Port (RS232) Module

Function	Description
Dual Serial ports	Two RS232 serial outputs Full RS232 functions with DB9 connectors Implements the EGP2-X203 (M.2 2242 Key B module)

5.4.5. Dual Serial Ports (RS232/422/485)

The system expansion I/O door with dual Serial Ports RS232/422/485 is factory installed and supports two RS232/422/485 software configurable serial ports.

The default setting is RS232 mode. To reconfigure the default mode, users must access the internal USB to UART via a Windows or Linux software interface and program the new RS mode over USB. For this the USB to UARTs manufacture's software utility "FT_PROG" is required.

For the dual Serial Port RS232/422/485 pin assignment, see Chapter 12.2.6: Dual Serial Port Connectors RS232/422/485 (X203, X204).

Table 17: DUAL Serial Port (RS232/422/485) Module

Function	Description
Dual Serial Ports	Two RS232/422/484 ports Default RS232 and software configurable to RS422 and RS485 9-pin D-Sub connectors (non-isolated) Implements the USB to Serial Controller FT231X

To reconfigure the default RS232 mode by software under Windows or Linux, perform the following:

1. Download the USB to UARTs manufactures's FT_PROG utility and user guide. For Windows visit the [FTDI Chip Utilities website](#) and for Linux visit the [FTx-PROG Linux repository](#).
2. Within the FT_PROG utility set the CBUS signals to the parameters shown in Table 18: RS Mode Configuration, for the required RS mode and perform a power cycle by restarting the product after successful programming.

Table 18: RS Mode Configuration

CBUS Signal	RS232 (default)	RS422/RS485 FD (Full Duplex)	RS485 HD (Half Duplex)
C0 (direction)	TXDEN	TXDEN	TXDEN
C1 (mode0)	Drive_1	Drive_1	Drive_0
C2 (mode1)	Drive_0	Drive_1	Drive_1
C3 (termination)	Drive_0	Drive_0	Drive_0

5.4.6. 8-Channel GPIO/DIO

The system expansion I/O door with 8-Channel GPIO/DIO is factory installed and supports eight GPIO bi-directional Digital IO (DIO) signals. Each of the eight GPIOs can be selected as an output or input channel.

The mating connector for the GPIO interface is not supplied with the product. For the 8-channel GPIO pin assignment with mating connector information, see Chapter 12.2.7: 8-Channel GPIO/DIO Connector (X231).



Both resistive and inductive loads can be connected to the GPIO interface.



The mating connector for the 8-Channel GPIO/DIO connector is not included in the delivery.

The GPIO input channel specification supports the following GP Input:

Figure 13: Input Application Connected to GPIO

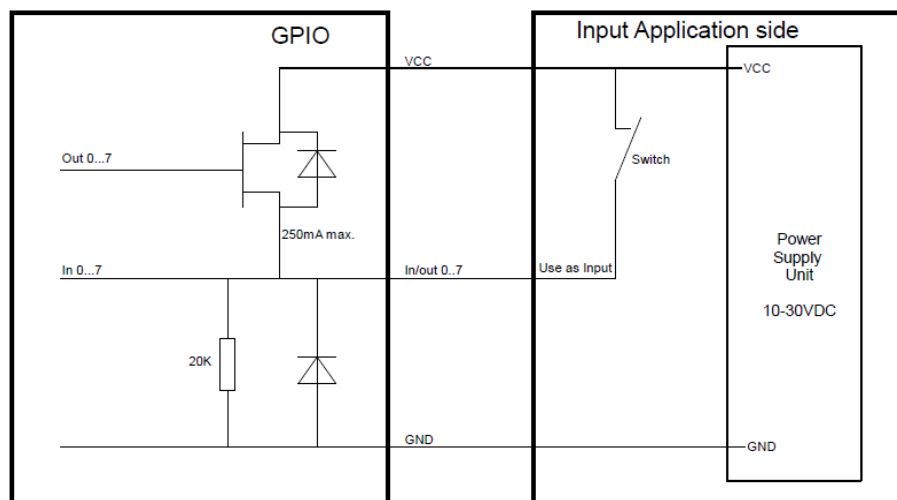

Table 19: GPIO Input Channel Specification

GPIO Input Channels	Description
Input Type	Input with integrated Pulldown resistor
Input Voltage	10 VDC to 30 VDC Max. GPIO input voltage depends on external Power IN Voltage ($V_{GPIOx} \leq V_{Power IN}$)
Input Pulldown Resistor	20 Kohm approx.
Input High level	>8.8 V
Input Low Level	<4.2 V
Input Hysteresis	>2.5 V

The GPIO output channel specification supports the following GP Output:

Figure 14: Output Application Connected to GPIO

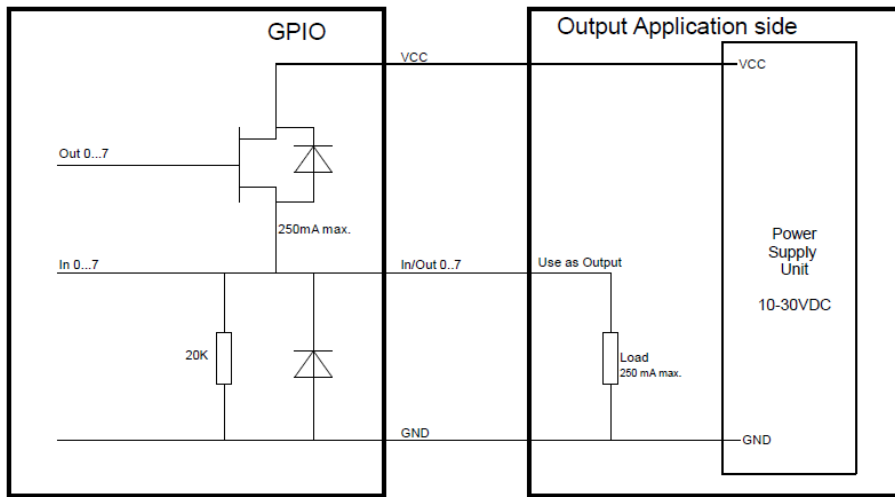

Table 20. GP Output Channels Specification

GPIO Output Channels	Description
Output Type	High side switch
Output Voltage	10 VDC to 30 VDC
Output Current	250 mA (Electrically limited to 500 mA max.)
Inductive Load Switch-off Energy Dissipation	40 mJ
Output Protection	Short-to-GND Protection by Current Limit. Thermal Shutdown with Output auto-retry. Inductive Load Negative Voltage Clamp.

6/Thermal and Power Management

6.1. Passive Cooling

The KBox A-251 is passively cooled using a heatsink and is fanless. All critical internal components are equipped with their own passive cooling solutions or are directly connected to the outer chassis to optimize heat transfer.

Observe a minimum clearance around the product, see Chapter 6.4: Minimum Heatsink Clearance.

CAUTION

Ensure Sufficient Airflow

Operate only in a well-ventilated environment that does not obstruct the airflow over the heatsink or obstruct the product from dissipating heat.

6.2. Heatsink

The heatsink on the top side can get very hot and precautions must be taken before handling or touching. Do not obstruct the airflow around the heatsink as this can stop sufficient heat dissipating into the ambient environment and cause a build-up of heat.



Hot Surface

Heatsinks can get very hot. To avoid burns and personal injury when handling the heatsink:

- › Do not touch while in operation
 - › Allow to cool before handling
 - › Wear protective gloves
-

6.3. Mount Orientation

The product is designed for vertical installation directly on a DIN Rail using the factory installed DIN Rail clamp. When mounting users must take care not to obstruct the vertical airflow over the heatsink, as this can stop sufficient heat dissipating into the ambient environment and cause a build-up of heat.

The orientation of the factory installed DIN Rail clamp can be changed by 180 degrees to support heatsink ventilation on the product's left or the right side.

6.4. Minimum Heatsink Clearance

To provide maximum heat dissipation away from the heatsink a minimum clearance distance of 12 mm (0.47 inch) to the surrounding environment must be observed, also known as keep out area in this user guide.

For sufficient air circulation around the product, Kontron recommends users not to mount or operate any other devices within the specified keep out area around the product.

CAUTION

Clearance

Leave sufficient clearance (keep out area) to prevent the product from overheating! To ensure proper operation observe the specified minimum clearance for the heatsink of 12 mm (0.47 inch).

6.5. Power Consumption and Thermal Monitoring

The maximum ambient temperature of the product depends mainly on the power consumption of the processor, the chipset, the installed M.2 modules and connected USB devices. Table 21 lists power consumption examples for a 15 W processor without external load and M.2 modules. The temperature limits for various load configurations can be found in Figure 15 to Figure 18. For the product's power specification, see Chapter 11.4: Power Specifications



The maximum ambient temperature depends mainly on the power consumption of the processor, chipset, the installed M.2 modules and the connected USB devices.

Table 21: Power Consumption Example with 15 W Processor

2.5"-SBC		W/O External Load & M.2
Intel® Core™ i3-N305 (PTat)	Processor TDP	15.0 W
SBC board	Board Losses	4.5 W
LAN 1 (BurnIn)	2GbE	0.9 W
LAN 2 (BurnIn)	2GbE	0.9 W
DP (BurnIn)	-	0.6 W
Serial Port (BurnIn)	-	0.3 W
DC/DC	-	1.33 W
Total		23 W

The power consumption of the expansion modules and USB loads can be found in Table 26: Power Consumption Interfaces and System Expansion I/O Door Options.

6.6. Derating TDP Curves

The derating TDP curves show how TDP power dissipation reduces to prevent overheating as the surrounding ambient temperature rises. The reference derating TDP curves act as a guideline to help users set TDP power limits to maintain safe operating conditions for the product's various load configurations. The derating TDP curves consider the maximum configuration without M.2 modules and external USB load.

The following performance curves were measured based on the AML/ADN processor platform, but are equally applicable to the other processor platforms of the same performance class (15 W, 12 W, 9 W, 6 W)

Figure 15: Derating TDP versus Temperature Curves (without expansion & airflow 0.8 m/s)

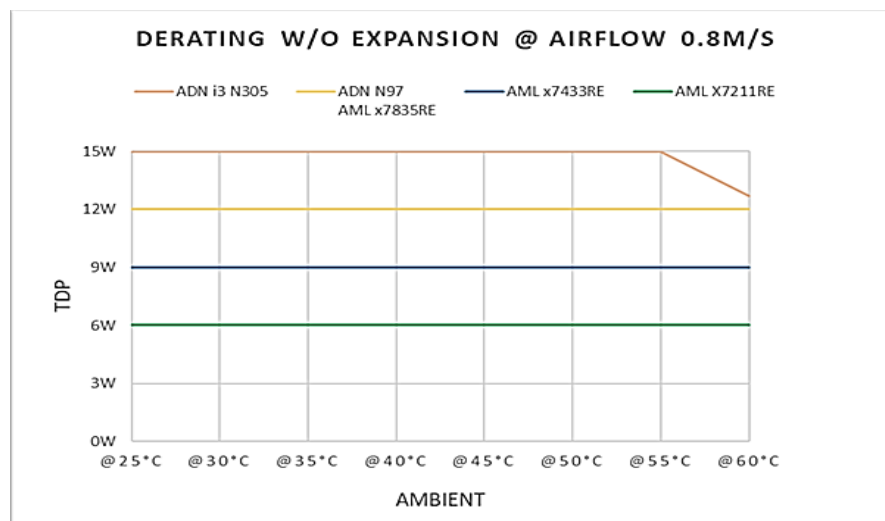

Figure 16: Derating TDP versus Temperature Curves (with full load & airflow 0.8 m/s)

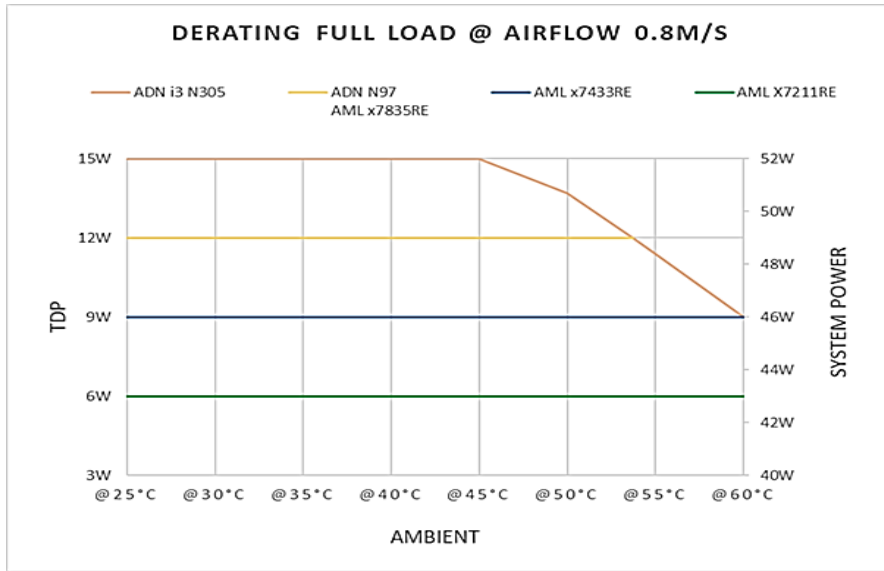
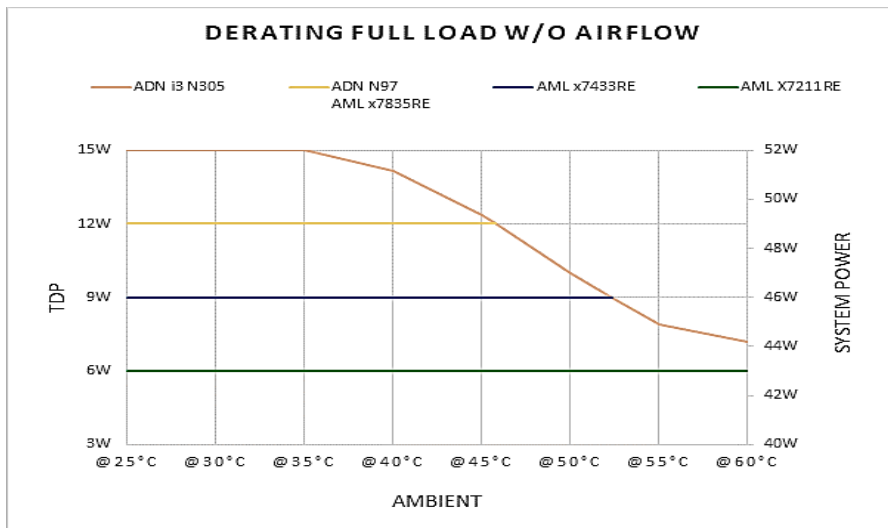
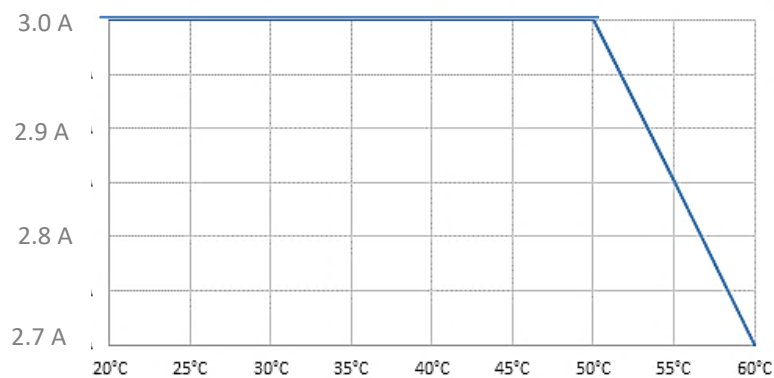

Figure 17: Derating TDP versus Temperature Curves (with full load & without airflow)



When using the USB-C port (X102) powered device (PD) functionality with 5 V and 3 A, Kontron recommends users to consider the derating current versus temperature for this port.

Figure 18: Derating Current USB-C Port (X102) versus Temperature Curve



6.7. Configuring the Processor TDP

The TDP can be configured in the BIOS Advanced setup menu, using the Configurable TDP Boot Mode. The BIOS default setting is [15 W] and possible settings are [15 W, 9 W, Deactivated].

6.8. Third Party Components

The product is factory configured as ordered and requires no further hardware configuration with third party components by the user. Opening the product to configure additional third-party components invalidates the warranty and the user must consider that an approximate internal temperature rise occurs. In this case, to avoid overheating the user is responsible for including an adequate cooling solution for any additional third-party components to absorb and transfer the excess heat produced.

NOTICE**Protection Label**

The product is factory configured and sealed with a protection label. Opening the product may damage internal components and invalidate the warranty.

7/Assembly

The KBox A-251 is factory configured and requires no further internal assembly.

NOTICE**Protection label**

The product is factory configured to meet customer requirements and then sealed with a protection label. Opening the product invalidates the warranty and may cause damage to internal components.

NOTICE

The internal components are not accessible in the field. For replacement or installation, the product must be returned to Kontron, see Chapter 15.1: Returning Defective Merchandise.

8/Installation

8.1. Before Installing

Before installing the KBox A-251 in the field, ensure that the operating environment meets the specification stated within this user guide, and that there is sufficient access to the Power IN connector, the front panel and connectors on the system expansion I/O door.

The product is designed for installation vertically in an industrial control cabinet. Kontron recommends expanding the product before installing the product in the end environment.

The DIN Rail clamp (default) or rugged DIN Rail clamp (option) are factory installed on the rear side of the product and can be reversed.

⚠ CAUTION

Ensure Sufficient Airflow

Install only in a well-ventilated environment that does not obstruct the airflow over the heatsink or obstruct the product from dissipating heat.

⚠ CAUTION

Installation Environment

Do not install the product close to heat sources or damp places.

NOTICE

Support Cables

Support the power and I/O cables to minimize the strain on the product's connectors.

8.2. Control Cabinet Mounting

The product is designed for installation vertically directly into a DIN Rail to support ventilation with vertical airflow over the heatsink to fully utilize the control cabinets vertical airflow for maximum heat dissipation. The orientation of the factory installed DIN Rail clamp can be reversed to enable the heatsink to be position on the product's left or the right side.

Figure 19: DIN Rail Clamp and Rugged DIN Rail Clamp (default position)

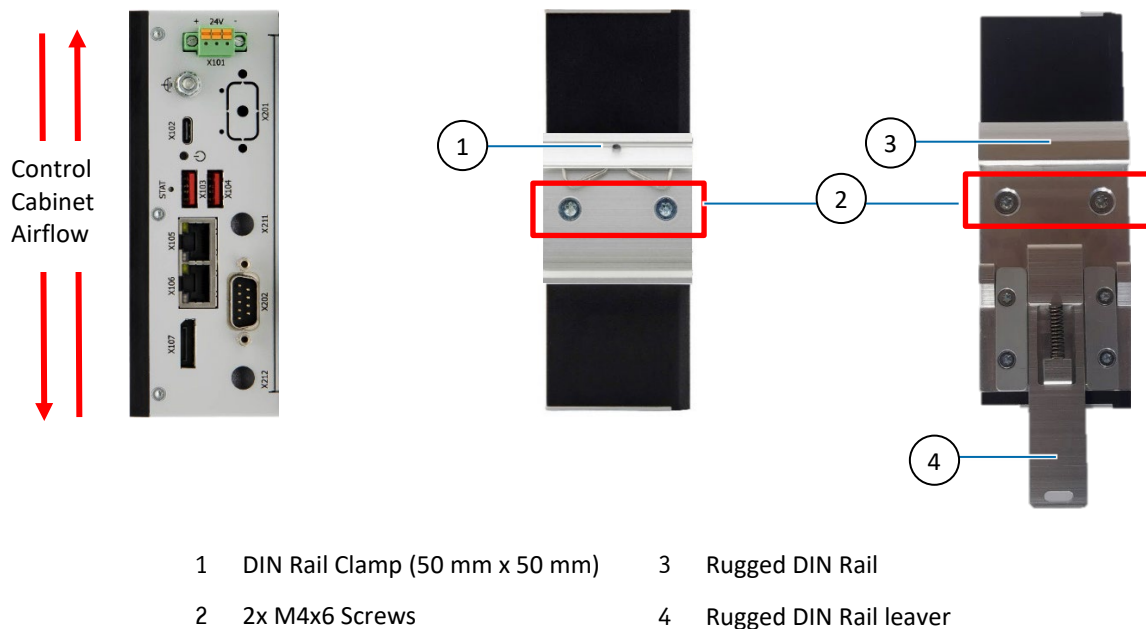

8.3. DIN Rail Clamp

The DIN Rail clamp 50 mm x 50 mm option mounts on the rear side. The default position is for vertical operation with the heatsink on the left side. The DIN Rail clamp is reversible. For a replacement DIN Rail Clamp, see Table 3: Accessories and Spare Parts.

To attach the DIN Rail clamp to a DIN Rail, perform the following:

1. Fasten the DIN Rail clamp (Figure 19, pos. 1) firmly using the supplied two M4x6 screws (Figure 19, pos. 2) and a thread locking compound to secure the two screws.
2. Clip the top of the DIN Rail clamp onto the DIN Rail and push upwards. Slot the bottom of the DIN Rail clamp firmly on the DIN Rail.

NOTICE

Mounting Requirement

Always mount using the two M4x6 screws supplied with the DIN Rail Clamp.

8.4. Rugged DIN Rail Clamp

The Rugged DIN Rail clamp option mounts on the rear side. The default position is for vertical operation with the heatsink on the left side. The Rugged DIN Rail clamp is reversible. For a replacement Rugged DIN Rail Clamp, see Table 3: Accessories and Spare Parts.

To attach the Rugged DIN Rail clamp, perform the following:

1. Fasten the rugged DIN Rail clamp (Figure 19, pos. 3) firmly using the supplied two M4x6 screws (Figure 19, pos. 2) and a thread locking compound to secure the two screws.
2. Clip the top of the rugged DIN Rail clamps onto the DIN Rail and pull the rugged DIN Rail lever downwards to slot the bottom of the rugged DIN Rail clamp firmly on the DIN Rail and release the lever.

NOTICE

Mounting Requirement

Always mount using the two M4x6 screws supplied with the Rugged DIN Rail Clamp.

8.5. Clearance

For sufficient air circulation around the product, Kontron recommends users not to mount or operate any other devices within the specified keep out areas around the product. The keep out areas for the product are displayed in Figure 20: Connector Clearance, with 12 mm (0.47 inch) specified as the heatsink clearance.

The connector clearance (keep out area) on the front panel and system expansion I/O door increases with the addition of antennas and cables. The required clearance depends on the connector types and antenna types and is therefore user dependent.

CAUTION

Clearance

Leave sufficient clearance (keep out area) to prevent the product from overheating!
To ensure proper operation observe the specified minimum heatsink clearance of 12 mm (0.47 inch).



Cable clearance is user dependent and not specified in this user guide.

Figure 20: Connector Clearance

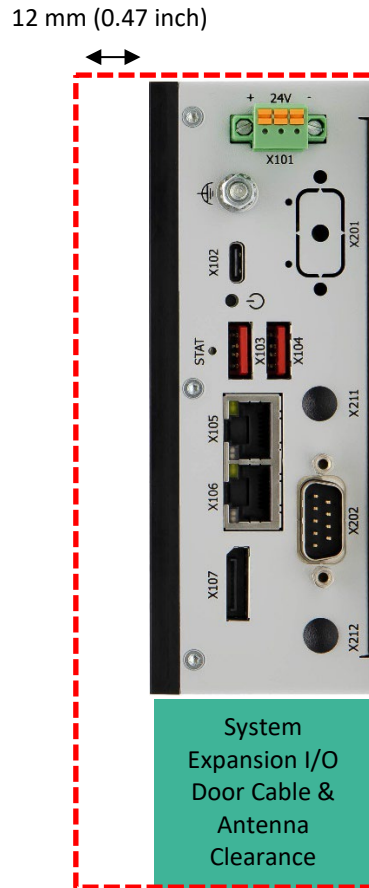

9/Starting UP

9.1. Before Starting

Before connecting the KBox A-251 to power, read the instructions in this user guide and observe the safety instructions in Chapter 2/General Safety Instructions.

External Power Supply

⚠ CAUTION

Only connect the product to an external power supply providing the voltage type (AC or DC) and the input power (max. current or max. power) specified on the Kontron Product Label and meeting the requirements of the Limited Power Source (LPS) and Power Source (PS2) of UL/IEC 62368-1.

Switch Off Properly!

⚠ CAUTION

Even when switched off using the power button, parts of the product are still energized. The product is only completely switched off when the power has been switched off using the power button and the power cable is disconnected from the Power IN connector.

Protection

⚠ CAUTION

Observe that wiring and short-circuit/overcurrent protection is performed according to the applicable standards, regulations and in respect to the product's electrical specification.

Disconnection Device

⚠ CAUTION

If there is limited access to the Power Cable use a disconnecting device, (fuse/circuit breaker) rated in accordance with the product wire cross-section.

Cable Damage

⚠ CAUTION

Ensure that the power cable has no visible damage.

Proper Cabling Procedure

NOTICE

To prevent a false power-on condition, that could result in operational failure. When installing or disconnecting cables ensure that:

- › The functional earth connection is made first and disconnected last.
 - › The last connection made is to the Power IN Connector.
-

Forced Shutdown

NOTICE

Disconnecting the power while the product is operating, performs a forced shutdown and can lead to loss of data or other undesirable effects! To shut down properly without data loss, switch off using the power button.

9.2. Connecting to an External 24 VDC Power Supply

The Power IN 24 VDC 3-pin connector connects to an external 24 VDC power supply using the mating connector included in the delivery. Only connect to a power supply unit within the specified voltage range that meets the product's electrical specification as stated in this user guide and on the product's type label and provides the required safety and protection features.

⚠ CAUTION

Only connect the product to an external power supply providing the voltage type (AC or DC) and the input power (max. power) specified on the Kontron Product Label and meeting the requirements of the Limited Power Source (LPS) and Power Source (PS2) of UL/IEC 62368-1.

Figure 21: 24 VDC Power IN Connector and Mating Power Connector

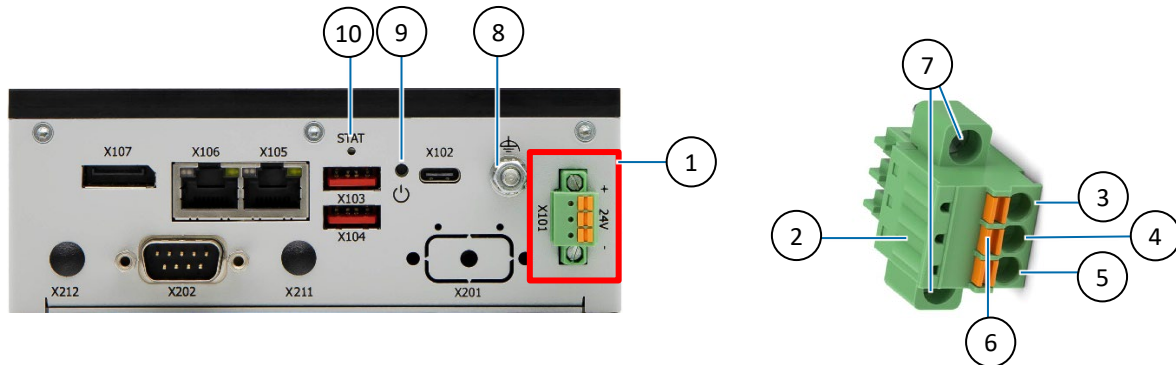

- | | | | |
|---|--|----|----------------------------|
| 1 | 24 VDC Power IN connector | 5 | Clamp for GND wire |
| 2 | 3-pin mating power connector
Phoenix type: 1.5/ 3-STF-3.5
(included in the delivery) | 6 | Three orange lock clips |
| 3 | Clamp for +24 VDC | 7 | Two screws |
| 4 | Clamp for GND wire | 8 | Functional Earth (FE) bolt |
| | | 9 | Power Button |
| | | 10 | STAT LED |

To connect to the external 24 VDC power supply and switch on the product, perform the following:

1. Wire the mating power connector (1.5/ 3-STF-3.5) included in the delivery, as described in Chapter 9.2.1: Wiring the Power IN Connector.
2. Switch off the external 24 VDC power supply via a disconnecting device (fuse/circuit breaker), to ensure that no power flows during the connection procedure.
3. Connect the functional earth bolt (Figure 21, pos. 8) to an appropriate common earth connection.
4. Connect the wired mating power connector to the 3-pin Power IN connector (Figure 21, pos. 1). Pay attention to the polarity of the connections and secure with the two screws (Figure 21, pos. 7).
5. Connect the other end of the wired mating power connector to the external 24 VDC power supply.
6. Switch on by pressing the power button (Figure 21, pos. 9) once and the STAT LED (Figure 21, pos. 10) illuminates.

9.2.1. Wiring the Power IN Connector

The mating power connector (Phoenix Type: 1.5/ 3-STF-3.5) included in the delivery connects to the Power IN connector and must be wired by the user. Only connect the wired mating connector to a power supply that meets the product's electrical specification as stated in this user guide and on the product's type label and provides the required safety and protection features.

The wiring is not part of the delivery and must be provided by the user. Use copper conductors only if the field wiring terminal is only for connection to copper wire and the field wiring terminals must have minimum temperature rating of 105° C. The wiring must be marked clearly with (+/-) clearly to ensure a safe connection.

To wire the supplied mating power connector (1.5/ 3-STF-3.5), perform the following:

1. Cut three (1 mm²) AWG 18 isolated wires to the required length and strip each end 5 mm to 7 mm.
2. Twist the striped wire-ends and provide them with ferrules.
3. Insert the end of the prepared wires into the corresponding opening on the mating power connector (Figure 21, pos. 3, 4, 5) until they engage and secure the wires. Ensure correct polarity.

NOTICE

Mark the supply wires (+/-) clearly to ensure a safe connection from the Power IN connector to the DC power supply.

9.3. Connecting to an External 12 VDC Power Supply

The Power IN 12 VDC connector connects to an external 12 VDC power supply that meets the product's electrical specification as stated in this user guide and on the product's type label and provides the required safety and protection features.

External Power Supply Specification

CAUTION

Only connect the product to an external power supply providing the voltage type (AC or DC) and the input power (max. current) specified on the Kontron Product Label and meeting the requirements of the Limited Power Source (LPS) and Power Source (PS2) of UL/IEC 62368-1.

Figure 22: Power IN 12 VDC Connector and Mating Power Connector

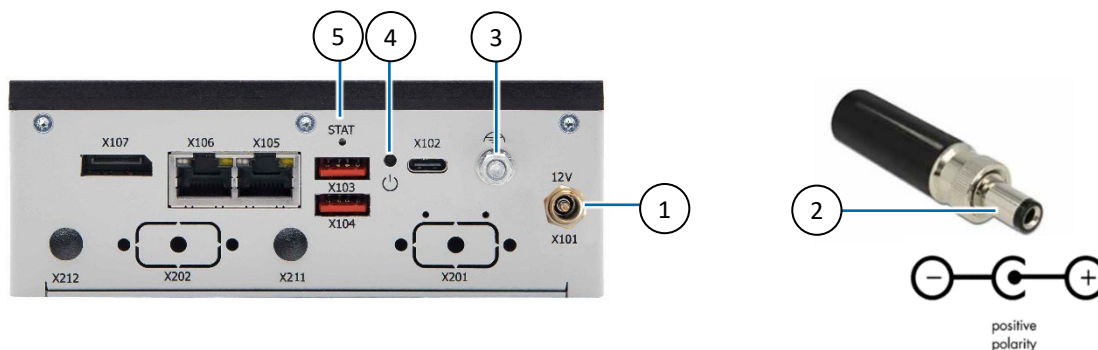

- | | | | |
|---|------------------------------|---|-----------------------|
| 1 | 12 VDC Power IN connector | 3 | Functional earth bolt |
| 2 | 12 VDC connector (Ø5.5/Ø2.1) | 4 | Power Button |
| | | 5 | STAT LED |

To connect to an external 12 VDC power supply and switch on the product, perform the following:

1. Connect the Functional Earth (FE) bolt (Figure 22, pos. 3) to an appropriate common earth connection.

2. Connect the power supply's cable with a positive polarity ($\varnothing 5.5/\varnothing 2.1$) connector (Figure 22, pos. 2), to the Power IN 12 VDC connector (Figure 22, pos. 1).
3. Connect the other end of the power supply to the mains power outlet using the correct plug for your region.
4. Switch on by pressing the power button (Figure 22, pos. 4) once and the STAT LED (Figure 22, pos. 5) illuminates.

9.4. Operating System (OS) and Drivers

If ordered with a pre-installed operating system, all drivers are installed in accordance with the ordered configuration, and the product is operational when switched on for the first time.

If ordered without a pre-installed operating system, users will need to install the operating system and the appropriate drivers for the configuration ordered.



To download relevant drivers for the factory installed hardware components, visit Kontron's [Customer Section](#).



Pay attention to the manufacturer's OS specifications relating to the integrated hardware components.

10/ Mobile Network

10.1. Before Setting Up

All software installed by the user is at the user's own risk. Kontron is not responsible for any malfunction, data loss, outage of various services and other problems caused by software installed by the user. Kontron is not responsible for the loss of stored, transmitted, received and used data. It is the user's responsibility to consider access control, and the protection measures required to prevent unwanted access.

10.2. Setting up the Mobile Network

Kontron provides a Board Support Package (BSP) including an installer with the required drivers for the supported Wi-Fi and/or mobile networks (LTE).

Kontron is not responsible for setup of the mobile network software and users must consider that setting up the product incorrectly can lead to the product becoming inaccessible. Kontron recommends testing the mobile network software in a safe test environment before installation in the field.



For the Board Support Package (BSP) and drivers, visit Kontron's [Customer Section](#) and click on KBox A- > KBox A-251 and select the Board Support Package/ Drivers/ Tools package.

10.3. Inserting a SIM Card

The SIM card's push push insertion and extraction enables quick and easy insertion or extraction. The SIM card slot is only for use in combination with the cellular LTE module and is not available for storage.

To insert or extract a SIM Card, refer to the Chapter 14/ Maintenance and Prevention.

NOTICE

Switch off to Insert/Extract SIM

Only insert or extract the SIM card if the product is switched off properly.



A SIM card is not part of the delivery and must be provided by the user, to support the required network.

Figure 23: SIM Card Holder



11/ Product Specification

11.1. Block Diagram

This chapter provides functional block diagram(s) for KBox A-251 variants based on Kontron’s 2.5”-SBC family.

Figure 24: Block Diagram - KBox A-251-AML/ADN

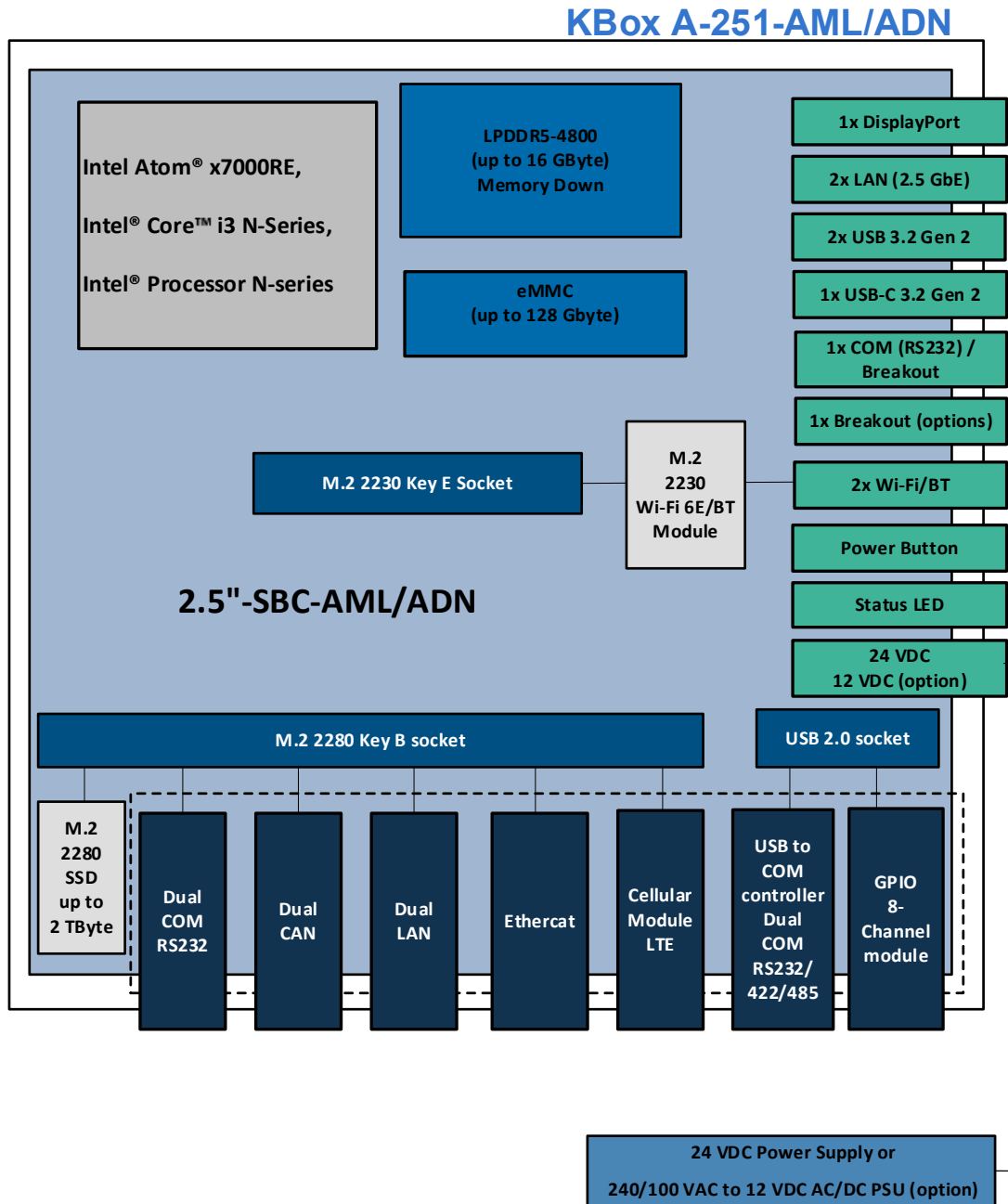

Legend



11.2. Hardware Specification

Table 22: Hardware Specification

KBox A-251	Description					
Model	KBox A-251					
Single Board Computer	2.5"-SBC					
Processor	Type	Core	Cache	Frequency (max.)	TCC/TSN	TDP
	Intel Atom® x7211RE	Dual	6 MB	up to 3.2 GHz	TCC/TSN	6 W TDP
	Intel Atom® x7433RE	Quad	6 MB	up to 3.4 GHz	TCC/TSN	9 W TDP
	Intel Atom® x7835RE	Octa	6 MB	up to 3.6 GHz	TCC/TSN	12 W TDP
	Intel® Core™ i3-N305	Octa	6 MB	up to 3.8 GHz		15 W TDP
	Intel® N97	Quad	6 MB	up to 3.6 GHz		12 W TDP
System Memory	Up to 16 GByte, LPDDR5 4800 MT/s memory down Single channel With 4 GByte, 8 GByte, 16 GByte					
	Up to 128 GByte eMMC With 32 GByte, 64 GByte, 128 GByte					
External Connectors	2x 2.5 GbE					
	2x USB 3.2 Gen 2 Type 1x USB-C 3.2 Gen 2/1 (processor dependent) with DP-Alt-Mode					
	1x full size DP					
	1x RS232 1x RS232 (option) or 1x SIM slot (option for cellular LTE only)					
Internal Expansion Sockets	M.2 Key E 2230 Interface: PCIe x1 / USB 2.0 Used for: Wi-Fi 6E / Bluetooth 5.3					
	M.2 Key B 2242 / 3042 / 3052 / 2280 Interface: PCIe x2 / USB 2.0 / SATA / UIM Used for: storage (with 256 GB, 512 GB, 1TB, 2TB) or System Expansion I/O door (Cellular LTE, dual CAN, EtherCAT, dual Serial Port (RS232) or dual LAN)					
System Expansion I/O Door options	Cellular LTE Cat 4 Dual LAN ports with 2x 2.5GbE with Speed and Activity LEDs Dual CAN with 2x CAN bus 2.0B ports EtherCat with 2x RJ45 EtherCat ports Dual Serial Port with 2x RS232 Dual Serial Port with 2x RS232/422/485 configurable 8-Channel GPIO/DIO					
RTC	RTC lithium battery with cable Type: BR2032, 3 V battery, Lifetime > 3 years (default) Automotive RTC lithium battery type BR2450, 3 V battery lifetime > 10 year (option)					
Power	Standard: 24 VDC (Range: 9 VDC to 36 VDC) Option: 12 VDC					
	Power Button					
LEDs	Status LED					

11.3. Software Specification

Table 23: Software Specification

KBox A-251	Description
Operating System (OS)	Windows 11 IoT Enterprise BSP and Image Linux Debian
BIOS	AMI Aptio V

11.4. Power Specifications

The default power solution is an external 24 VDC power supply connected via the mating power connector included in the delivery or an optional 12 VDC power solution, connected using a suitable power connector. Ensure that the external power supply meets the product's electrical specification and takes protection and supply limitation into consideration.

11.4.1. External 24 VDC Power Supply

Ensure that the external 24 VDC power supply meets the required electrical specification for the product and takes protection and supply limitation into consideration.

External Power Supply

⚠ CAUTION

Only connect the product to an external 24 VDC power supply providing the input power (max. current) specified on the Kontron Product Label and meeting the requirements of the Limited Power Source (LPS) and Power Source (PS2) of UL/IEC 62368-1.

Use Power Connected Provided

⚠ CAUTION

Only connect the product to Power IN using the delivered mating power connector

Protection and Disconnection Device

⚠ CAUTION

Observe that wiring and short-circuit/overcurrent protection is performed according to the applicable standards, regulations and in respect to the product's electrical specification. If implemented the disconnecting device (fuse/circuit breaker) rating must be in accordance with the product's wire cross-section.

Manufacturer's Instructions

NOTICE

Ensure that the external 24 DC power supply is used according to the manufacturer's instructions and has been fully tested to meet the minimum immunity of AC inputs requirements, as stipulated in IEC 55024.

Correct Power Cables

NOTICE

To protect the product and any connected peripherals, make sure that the power cables have the right diameter to withstand the maximum available current.

Table 24: Electrical Specification External 24 VDC Power Supply (default)

Power Source	Power IN 24 VDC
Output Voltage	24 VDC Range: 9 VDC to 36 VDC (wide range)
Output Power (max.)	60 W

11.4.2. External 12 VDC Power Supply

Ensure that the external 12 VDC power supply meets the product's electrical specification and takes protection and supply limitation into consideration. The external 12 VDC power supply must automatically recover from AC power loss and start up under peak loading. Connect the product only to an external 12 VDC power supply designed to achieve NEC Class-2 and Limited Power Source (LPS).

External Power Supply

⚠ CAUTION

Only connect the product to an external 12 VDC power supply providing the input power (max. current) specified on the Kontron Product Label and meeting the requirements of the Limited Power Source (LPS) and Power Source (PS2) of UL/IEC 62368-1

Use Power Connector Provided

⚠ CAUTION

Only connect the product to the Power IN connector using a suitable mating power connector.

Protection and Disconnection Device

⚠ CAUTION

Observe that wiring and short-circuit/overcurrent protection is performed according to the applicable standards, regulations and in respect to the product's electrical specification. If implemented the disconnecting device (fuse/circuit breaker) rating must be in accordance with the product's wire cross-section.

Manufacturer's Instructions

NOTICE

Ensure that the external 12 DC power supply is used according to the manufacturer's instructions and has been fully tested to meet the minimum immunity of AC inputs requirements, as stipulated in IEC 55024.

Correct Power Cables

NOTICE

To protect the product and any connected peripherals, make sure that the power cables have the right diameter to withstand the maximum available current.

Table 25: Electrical Specification External 12 VDC Power Supply (option)

Power Source	External 12 VDC Power Supply
Output Voltage	12 VDC (+10%/-5%)
Output Current	5 A max.

11.4.3. Power Supply Protection Requirements

The external power supply (24 VDC/12 VDC) is required to incorporate protection and supply features such as over current protection, inrush current protection, over voltage protection and under voltage (brownout) protection, to protect the product against fluctuations and interruptions in the delivered DC power supply. Be aware that the DC power supply must be able to handle peak currents for several seconds.

Brownout

NOTICE

If an under voltage (brownout) condition occurs the used power supply must remain in the “off state” long enough to allow internal voltages to discharge sufficiently. Failure to observe this “off state” may mean that parts of the product or peripherals work incorrectly or suffer a reduction of MTBF. The minimum “off state”, to allow internal voltages to discharge sufficiently, is dependent on the power supply and additional electrical factors. To determine the required “off state”, each case must be considered individually. For more information, contact Kontron Support.

11.4.4. Power Consumption

The base power consumption of the product depends on factors such as the input voltage, the processor installed on the 2.5”-SBC board, and the standard board interfaces. The difference between the total power and the base consumption results in the capacity for expansion and additional power consumption.

The following performance curves were measured based on the AML/ADN processor platform, but are equally applicable to the other processor platforms of the same performance class (15 W, 12 W, 9 W, 6 W)

Figure 25: Voltage/Power Derating and Consumption/Capacity Curve Examples

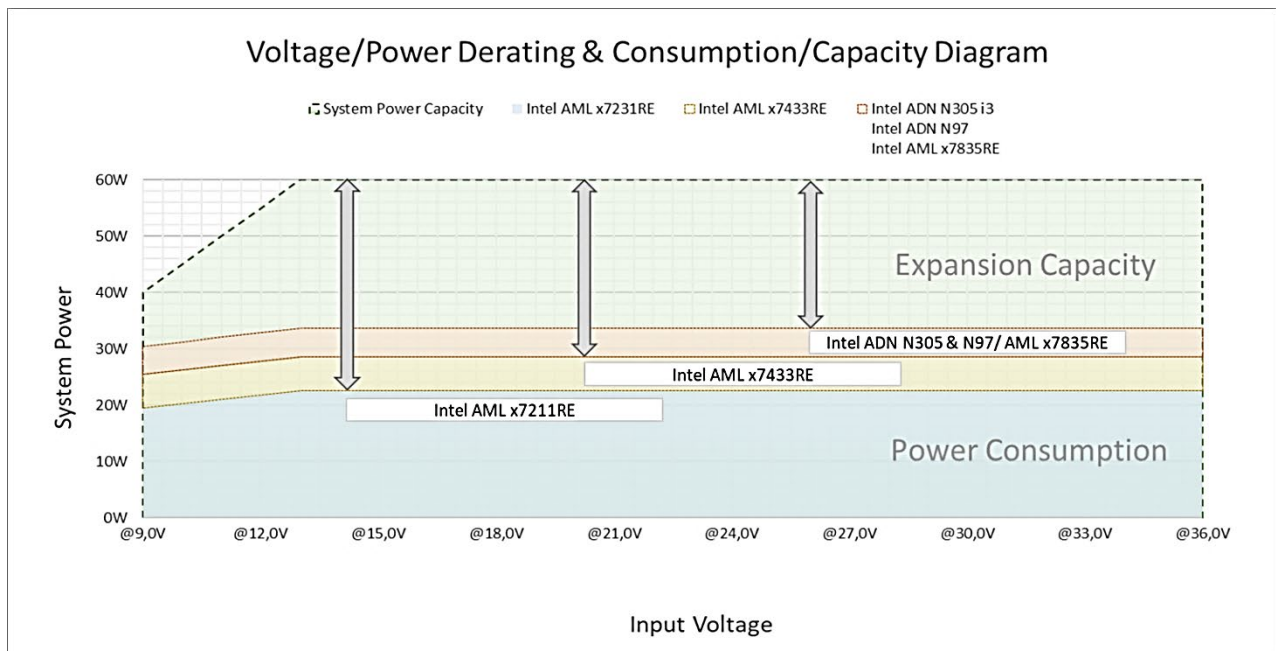

It is the user’s responsibility to ensure that the power consumption of the additional interfaces and system expansion I/O door option does not exceed the theoretical total available power capacity of 60 W. In some cases, this could require limiting USB port power consumption, see Table 26: Power Consumption Interfaces and System Expansion I/O Door Options.

Table 26: Power Consumption Interfaces and System Expansion I/O Door Options

Expansion Options	Power Consumption
USB Type A port	4.5 W per port
USB Type C port	15 W
M.2 2280 SSD module	1.40 W
M.2 Wi-Fi/BT® module	2.98 W
System Expansion I/O door Cellular LTE	2.5 W
System Expansion I/O door Dual Serial Ports(RS232)	1.55 W
System Expansion I/O door Dual CAN	2.83 W
System Expansion I/O door Dual LAN 2.5 GbE	3.08 W
System Expansion I/O door EtherCAT	2.15 W
System Expansion I/O door GPIO 8-channel	0.5 W
System Expansion I/O door Dual Serial Ports (RS232/422/485)	1.0 W

11.4.5. Functional Earth

The functional earth bolt connects to the internal chassis ground. There is no isolation between the Power IN GND (-) and the system chassis. Always include a functional earth connection.

To avoid damage to the product, observe proper grounding methods:

1. Connect the product to ground before switching on the product.
2. Only connect the product to an applied ground that meets all applicable local, national and international grounding requirements.
3. When assembling the product, connect the ground cable first and when disassembling removed the ground cable last.

CAUTION

Ground Properly

The installation site's ground must meet your local, national and international region grounding requirements.

11.5. Environmental Specification

Table 27: Environmental Specification

Environmental	Description
Temperature (Operating) According to IEC 60068-2-1/-2-2	Standard: 0°C to 60°C (32°F to 140°F) Extended: -40°C to 60° (-40°F to 140°F)
Temperature (Non-operating) According to IEC 60068-2-1/-2-2	-40°C to +85°C (-40°F to 121°F)
Humidity According to IEC 60068-2-78	93% RH at 40°C (104°F), non-condensing
Shock (Operating) According to IEC 60068-2-27	Peak Acceleration.: 15 g, Shock Duration: 11 ms half sine, Shock Count: 3/direction, total 18
Shock (Non-operating) According to IEC 60068-2-27	Peak Acceleration. 30 g, Shock Duration: 11 ms half sine, Shock Count: 3/direction, total 18
Vibration (Operating) According to IEC 60068-2-6	Frequency: 10 Hz - 150 Hz Acceleration: 2g
Altitude (Operating)	3000 m max. (9800 ft. max.)
Altitude (Non-operating)	10,000 m max. (32800 ft. max.)
Cooling Solution	Passive cooling solution via heatsink
MTBF	188,303 hours @ 30°C (86°F) Ground Benign (GB) For the KBox A-251-AN-N97

11.6. Mechanical Specification

Table 28: Mechanical Specification

Mechanical	Description
Material	Chassis: Steel Heatsink: Aluminium
Dimension (W x H x D)	137 mm x 50 mm x 95 mm (5.394" x 1.969" x 3.740")
Color	RAL7035 (front panel and main chassis) Black (rear panel and heatsink)
Mounting	DIN-Rail or Rugged DIN-Rail
Weight	< 1 kg approx. (2.2 lbs. approx.)
Protection Class	IP20

Figure 26: Mechanical Dimensions (mm)

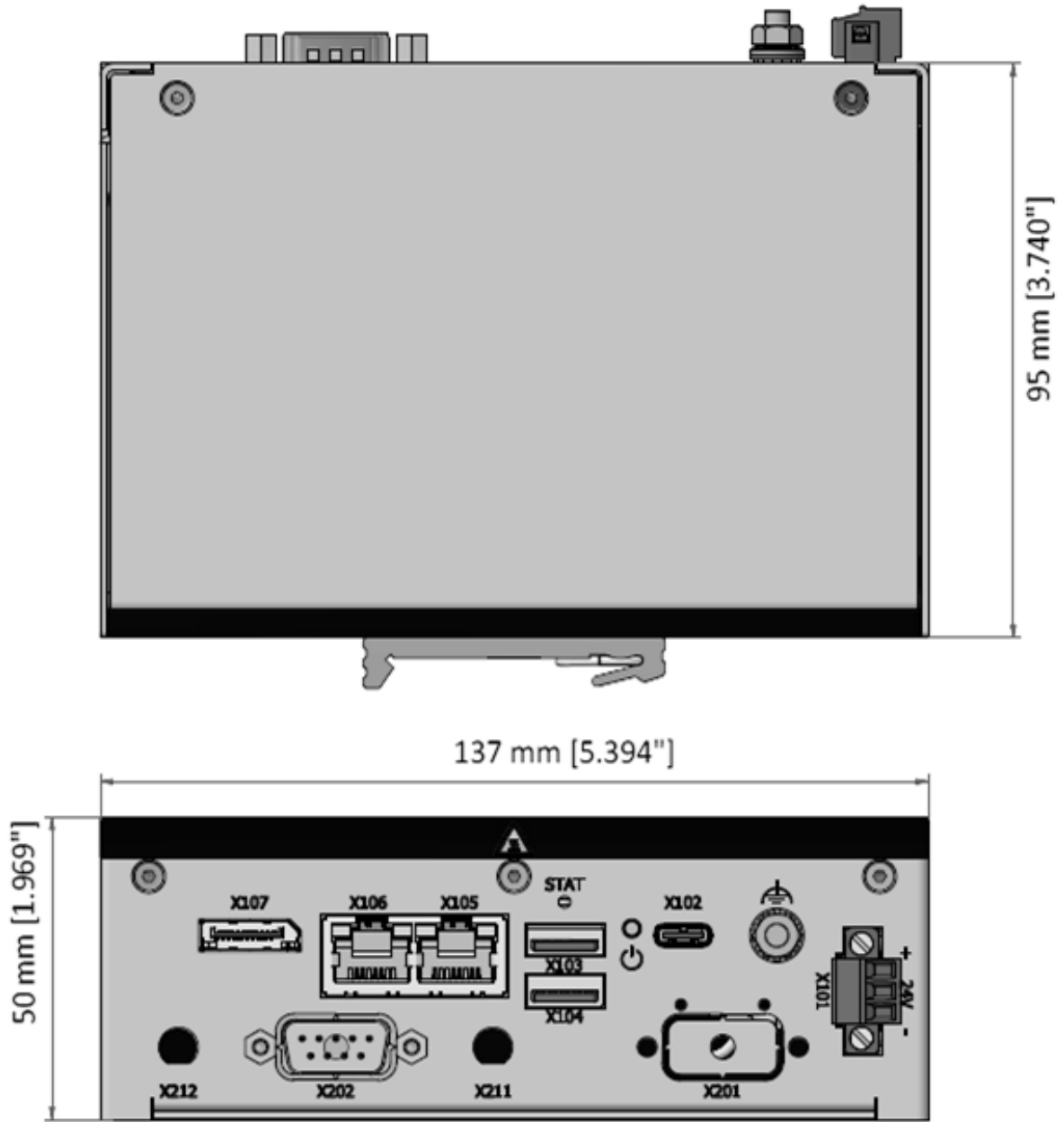

To access the KBox A 251 STEP files, visit Kontron's [Customer Section](#).

11.7. Compliance

The KBox A-251 plans to comply with the relevant requirements and the approximation of the laws relating to the following standards (or later thereof) that are constitutional parts of the declaration.

Table 29: Compliance

KBox A-251	Compliance
EMC	CE / FCC / IC
Radio	CE / FCC / IC
Safety	UL



For the Declaration of Conformity (DoC), visit Kontron's [Customer Section](#).



If the product is modified, the prerequisites for specific approvals may no longer apply.



For compliance with Wi-Fi or LTE modules, use the Kontron reference antenna provided in the delivery and chosen to comply with the manufacture's requirements.



Kontron is not responsible for any radio television interference caused by unauthorized modifications of the delivered product or the substitution or attachment of connecting cables and equipment other than those specified by Kontron. The correction of interference caused by unauthorized modification, substitution or attachment is the user's responsibility.

12/ Connectors and LEDs



This chapter describes the KBox A-251 external connectors, status LED and slots.

12.1. Front Panel Connector Pin Assignments

12.1.1. Power IN 24 VDC (X101)(default)

The Power IN connector connects to a 24 VDC DC power supply using the supplied mating power connector.

Table 30: Power IN Connector Pin Assignment

3-Pin Phoenix Power Connector	Pin	Signal Name	Description
 1 3	1	VCC (+)	24 VDC (Range: 9 VDC to 36 VDC)
	2	GND (-)	Ground
	3	GND (-)	Ground
Mating Power Connector	3-pin 1.5/ 3-STF-3.5 		

Always include a Functional Earth

⚠ CAUTION

There is no isolation between the Power IN GND (-) and the system chassis.
Always include a functional earth connection.

External Power Supply



⚠ CAUTION

Only connect the product to an external 24 VDC power supply providing the input power (max. current) specified on the Kontron Product Label and meeting the requirements of the Limited Power Source (LPS) and Power Source (PS2) of UL/IEC 62368-1.

12.1.2. Power IN 12 VDC Connector (X101) (option)

The optional 12 VDC Power IN connector connects to a 12 VDC power supply using a mating power connector provided by the user of type positive polarity.

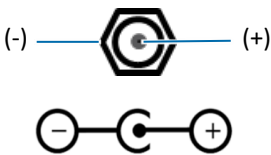
Table 31: 12 VDC Power Connector Pin Assignment

Pin	Signal Name	Barrel Connector (5.5 mm/ 2.1 mm) with Center Pole
Centre pole	+12 VDC	 Positive polarity
Outer ring	Ground (-)	
Mating Power Connector	 Positive polarity	

Always include a Functional Earth**⚠ CAUTION**

There is no isolation between the Power IN GND (-) and the system chassis.
Always include a functional earth connection.

External Power Supply**⚠ CAUTION**

Only connect the product to an external 12 VDC power supply providing the input power (max. current) specified on the Kontron Product Label and meeting the requirements of the Limited Power Source (LPS) and Power Source (PS2) of UL/IEC 62368-1.

12.1.3. USB-C Port (X102)

The USB-C port connector (X102) supports DP-Alt-Mode.

Table 32: USB-C Port Pin Assignment

USB-C	Pin	Signal	Pin	Signal
	A1	GND	B12	GND
	A2	CON_TX1P_C	B11	CON_RX1P_C
	A3	CON_TX1N_C	B10	CON_RX1N_C
	A4	+5 V_VBus	B9	+5 V_VBUS
	A5	CC1	B8	SBU2
	A6	USB2_P	B7	USB2_N
	A7	USB2_N	B6	USB2_P
	A8	SBU1	B5	CC2
	A9	+5 V_VBUS	B4	+5 V_VBUS
	A10	CON_RX2N_C	B3	CON_TX2N_C
	A11	CON_RX2P_C	B2	CON_TX2P_C
	A12	GND	B1	GND

Signal Name	Description
CON_TX#P/N_C	USB3_TX#+/-/DP Lane # TX+/-
CON_RX#P/N_C	Highspeed data path (RX (+/-) for USB or TX for DP-Alt-Mode)
USB2_P/N	USB 2.0 interface differential pair (+/-)
CC#	Configuration Channel signal
SBU#	Side Band Use signal #. DP Auxiliary channel differential pair (+/-)
+5 V_VBus	+5 V Bus power
GND	Ground

USB -C Type

- Intel Atom® x7000RE series of processors support USB-C 3.2 Gen 1
- Intel® Core™ i3 N-series & Intel® Processor N-series support USB-C 3.2 Gen 2

12.1.4. USB 3.2 Gen 2 Ports (X103, X104)

The two USB ports connectors (X103, X104) support USB 3.2 Gen 2 compatible devices.

Table 33: USB 3.2 Gen 2 Type A Port Pin Assignment

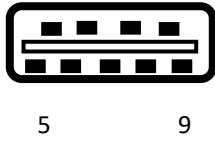
USB Type A	Pin	Signal Name	Description
	1	+USB_VCC	+5 V power supply for USB device
	2	USB_D-	USB 2.0 differential pair (-)
	3	USB_D+	USB 2.0 differential pair (+)
	4	GND	Ground
	5	USB_RX-	USB 3.2 receiver differential pair (-)
	6	USB_RX+	USB 3.2 receiver differential pair (+)
	7	GND	Ground
	8	USB_TX-	USB 3.2 transmitter differential pair (-)
	9	USB_TX+	USB 3.2 transmitter differential pair (+)



The USB 3.2 Gen 2 ports are backwards compatible with USB 3.2 Gen 1 and USB 2.0 ports.

12.1.5. Ethernet 2.5 GbE Ports (X105, X106)

The two RJ45 Ethernet port (X105, X106) support 10/100/1000/2500 Mbit Ethernet with two LEDs indicating speed and activity.

Table 34: Ethernet 2.5 GbE Port Pin Assignment

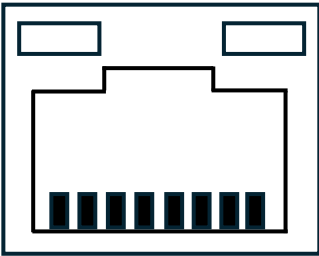
RJ45 (female) X106/X105	Pin	Signal Name
<div style="display: flex; justify-content: space-around;"> <div style="text-align: center;"> <p>Link Activity LED</p>  </div> <div style="text-align: center;"> <p>Speed LED</p> </div> </div>	1	TX1+
	2	TX1-
	3	TX2+
	4	TX3+
	5	TX3-
	6	TX2-
	7	TX4+
	8	TX4-

LED Link Status		LED Speed	
Off	Link down	Off	10/100 Mbit/s link established
Yellow Flashing	Link up and active	Orange	1000 Mbit/s link established
Yellow	Link up and no activity	Green	2.5 Gbit/s link established

Signal	Description
TX1+ / TX1-	In MDI mode, this is the first pair in 2.5GBase-T and 1000Base-T, i.e. the BI_DA+/- pair, and is the transmit pair in 10Base-T and 100Base-TX. In MDI crossover mode, this pair acts as the BI_DB+/- pair, and is the receive pair in 10Base-T and 100Base-TX.

Signal	Description
TX2+ / TX2-	In MDI mode, this is the second pair in 2.5GBase-T and 1000Base-T, i.e. the BI_DB+/- pair, and is the receive pair in 10Base-T and 100Base-TX. In MDI crossover mode, this pair acts as the BI_DA+/- pair, and is the transmit pair in 10Base-T and 100Base-TX.
TX3+ / TX3-	In MDI mode, this is the third pair in 2.5GBase-T and 1000Base-T, i.e. the BI_DC+/- pair. In MDI crossover mode, this pair acts as the BI_DD+/- pair.
TX4+ / TX4-	In MDI mode, this is the fourth pair in 2.5GBase-T and 1000Base-T, i.e. the BI_DD+/- pair. In MDI crossover mode, this pair acts as the BI_DC+/- pair.



To achieve the specified performance of the Ethernet port, Category 5 twisted pair cables must be used with 10/100 MByte and Category 5E, 6 or 6E with 1 Gbit/2.5 Gbit LAN networks.



Connected only to internal Ethernet networks, without exiting a facility and being subjected to TNVs.

12.1.6. DisplayPort Connectors (X107)

The DisplayPort (DP) connector (X107) is a standard DP port.

Table 35: DisplayPort Connector Pin Assignment

20-pin Standard DP Connector (female)	Pin	Signal Name	Pin	Signal Name
	1	ML_Lane0p	11	GND
	2	GND	12	ML_Lane3n
	3	ML_Lane0n	13	Config1
	4	ML_Lane1p	14	Config2
	5	GND	15	AUX_CHp
	6	ML_Lane1n	16	GND
	7	ML_Lane2p	17	AUX CHn
	8	GND	18	Hot-Plug
	9	ML_Lane2-	19	GND
	10	ML_Lane3p	20	DP_PWR

Signal Name	Description
ML_Lane#p/n	DisplayPort Lane # transmitter differential pair (+/-)
Aux +/-	Auxiliary channel differential pair (+)
Hot-Plug	Hot plug detect
Config#	Connect to Ground directly or via a pulldown device
GND	Ground signal
DP_PWR	Power supply signal for connector

12.1.7. Serial Port Connectors (X202) and (X201 option)

The Serial Port connector (X202) and the optional Serial Port breakout (X201) both support RS232 with RX/TX and no handshaking.

Table 36: Serial Port (RS232) Pin Assignment

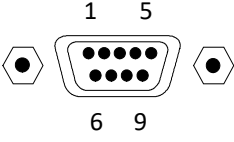
9-pin D-SUB (male)	Pin	RS232	Description
	1		
	2	RxD	Receive Data sends data to the communications link (straight-through connection)
	3	TxD	Transmit Data sends data to the communications link (straight-through connection)
	4		
	5	GND	Ground signal
	6		
	7		
	8		
	9		

12.1.8. SIM Slot Card Holder (X201, option)

The SIM slot card slot (X201) supports a standard SIM card (15 mm x 25 mm) supplied by the user to support the user's cellular network.

NOTICE

Switch off to Insert/Extract SIM

Only insert or extract the SIM card if the product is switched off properly.



12.1.9. Antenna Connectors (X211, X212)



The two antenna connectors (X211, X212) are either Wi-Fi or cellular LTE. Wi-Fi and cellular LTE use different antenna types that are not electrically compatible and not interchangeable. All antennas are included in the delivery. Kontron recommends that users only connect the delivered reference antenna chosen to meet product requirements.

For more information regarding the reference antenna and the antenna requirements, see Table 3: Accessories and Spare Parts.

Before connecting to the product's antenna connectors ensure that you are connecting the correct antenna type. Users are responsible for connecting the correct type of antenna to the product's antenna connectors.

Table 37: Antenna Type

Antenna Connector	Antenna Description
Wi-Fi/BT®  RP-SMA (female) with center pin and outer thread.	Wi-Fi  RP-SMA (male) antenna with pin socket and inner thread. 

Antenna Connector	Antenna Description
<p>Cellular LTE</p>  <p>SMA (female) with pin socket and outer thread.</p>	<p>Cellular LTE</p>   <p>SMA (male) Antenna with center pin and inner thread.</p>

Antenna RF exposure

To avoid RF antenna exposure:

⚠ CAUTION

- Avoid placing the antenna near people, minimum distance 20 cm.
- Avoid pointing the antenna at people.
- Keep a safe distance from the antenna especially when transmitting.

NOTICE

RP-SMA and SMA Antenna are not Interchangeable!

RP-SMA and SMA connectors and antenna are not electrically compatible. Incorrect connection may result in an insufficient connection or destroy the center pin.



The antenna position may affect the performance. Do not place the antenna close to a noise source that may cause interference.



Kontron recommends the use of Kontron's reference antenna included in the delivery and chosen to meet RF performance requirements, and to support a nominal impedance of 50 ohms, see Table 3: Accessories and Spare Parts.



12.2. System Expansion I/O Door Options

12.2.1. Cellular LTE Antenna (X213, X214)

The two cellular LTE antenna connectors (X213, X214) are SMA (female) and require SMA (male) plug antenna. The two SMA antennas are included in the delivery. All antennas are included in the delivery. Kontron recommends that users only connect the delivered reference antenna chosen to meet product requirements. For more information regarding the reference antenna and the antenna requirements, see Table 3: Accessories and Spare Parts.

Before connecting to the product’s antenna connectors ensure that you are connecting the correct antenna type. Users are responsible for connecting the correct type of antenna to the product’s antenna connectors.

Table 38: Cellular LTE Antenna Connectors

Antenna Connector	SMA Antenna Description
 <p>Cellular LTE</p> <p>SMA (female) with center pin socket and outer thread.</p>	  <p>Cellular LTE</p> <p>SMA (male) Antenna with center pin and inner thread.</p>

Antenna RF exposure

To avoid RF antenna exposure:

CAUTION

- Avoid placing the antenna near people, minimum distance 20 cm.
- Avoid pointing the antenna at people.
- Keep a safe distance from the antenna especially when transmitting.

NOTICE

RP-SMA and SMA Antenna are not Interchangeable!

RP-SMA and SMA connectors and antenna are not electrically compatible. Incorrect connection may result in an insufficient connection or destroy the center pin.



The antenna position may affect the performance. Do not place the antenna close to a noise source that may cause interference.



Kontron recommends the use of Kontron’s reference antenna included in the delivery and chosen to meet RF performance requirements, and to support a nominal impedance of 50 ohms, see Table 3: Accessories and Spare Parts.

12.2.2. Dual LAN Connectors (X241, X242)

Table 39: Dual (2.5 GbE) LAN Ports Pin Assignment

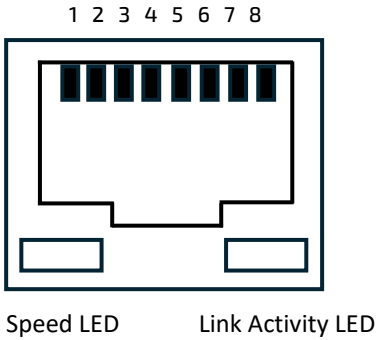
RJ45 (female)	Pin	Signal Name
	1	TX1+
	2	TX1-
	3	TX2+
	4	TX3+
	5	TX3-
	6	TX2-
	7	TX4+
	8	TX4-

Speed LED		Link Activity LED	
Off	10/100 Mbit/s	Off	Link down
Orange	1000 Mbit/s	Green Flashing	Link up and active
Green	2500 Mbit/S	Green	Link up and no activity

Signal	Description
TX1+ / TX1-	In MDI mode, this is the first pair in 2.5GBase-T and 1000Base-T, i.e. the BI_DA+/- pair, and is the transmit pair in 10Base-T and 100Base-TX. In MDI crossover mode, this pair acts as the BI_DB+/- pair, and is the receive pair in 10Base-T and 100Base-TX.
TX2+ / TX2-	In MDI mode, this is the second pair in 2.5GBase-T and 1000Base-T, i.e. the BI_DB+/- pair, and is the receive pair in 10Base-T and 100Base-TX. In MDI crossover mode, this pair acts as the BI_DA+/- pair, and is the transmit pair in 10Base-T and 100Base-TX.
TX3+ / TX3-	In MDI mode, this is the third pair in 2.5GBase-T and 1000Base-T, i.e. the BI_DC+/- pair. In MDI crossover mode, this pair acts as the BI_DD+/- pair.
TX4+ / TX4-	In MDI mode, this is the fourth pair in 2.5GBase-T and 1000Base-T, i.e. the BI_DD+/- pair. In MDI crossover mode, this pair acts as the BI_DC+/- pair.

12.2.3. Dual CAN Bus Connectors (X203, X204)

Table 40: Dual CAN Ports Pin Assignment

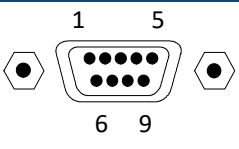
9-pin D-SUB	Pin	Signal Name	Description	Pin	Signal Name	Description
	1	NC		6	NC	NC
	2	CAN-L	Dominant low line	7	CAN-H	Dominant high line
	3	GND	CAN Ground	8	NC	NC
	4	NC		9	NC	NC
	5	NC				

12.2.4. EtherCAT Connectors (X221, X222)

Table 41: EtherCAT Port Pin Assignment

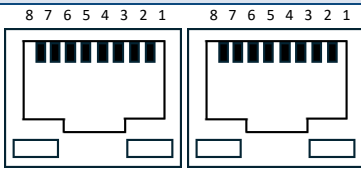
RJ45 Port (female)	Pin	Signal Name	Description
	1	TX+	Transmit data + channel
	2	TX-	Transmit data - channel
	3	RX +	Receive data + channel
	4	Term 1	Bridged and terminated to PE via RC link
	5	Term 1	
	6	RX -	Receive data - channel
	7	Term 2	Bridged and terminated to PE via RC link
	8	Term 2	

LED: Link Green		LED Activity Yellow	
Off	No link to the Ethernet	Off	LED is not used
Green	Linked to the Ethernet but does not send or receive frames		
Green Flashing	Linked to the Ethernet and sends/receives Ethernet frames		

12.2.5. Dual Serial Port Connectors RS232 (X203, X204)

Table 42: Dual Serial Port (RS232) Pin Assignment

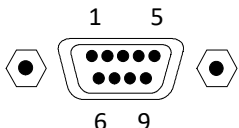
9-pin D-SUB (male)	Pin	RS232
	1	DCD
	2	RxD
	3	TxD
	4	DTR
	5	GND
	6	DSR
	7	RTS
	8	CTS
	9	RI

Signal Name	Description
DCD	Data Carrier Detect
RxD	Receive Data sends data to the communications link (straight-through connection)
TxD	Transmitted Data sends data to the communications link (straight-through connection)
DTR	Data Terminal Ready indicates that the on-board UART is ready to establish communication link.
DSR	Data Set Ready, indicates that the modem etc. is ready to establish a communications link.
RTS	Request To Send, indicates to the modem etc. that the on-board UART is ready to
CTS	Clear to send
RI	Ring Indicator, indicates that the modem has received a ringing signal from the telephone line.
GND	GND signal

12.2.6. Dual Serial Port Connectors RS232/422/485 (X203, X204)

The dual Serial Ports (RS232/422/484) are default RS232 and RS422/485 software configurable. For more information, see Chapter 5.4.5: Dual Serial Port RS232/422/485.

Table 43: Dual Serial Port (RS232/422/485) Pin Assignment

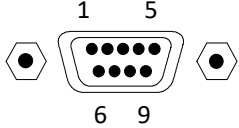
9-pin D-SUB (male)	Pin	RS232	RS422	RS485 (Full Duplex)
	1	DCD	Tx-	Tx-
	2	RxD	Tx+	Tx+
	3	TxD	Rx+	Rx+
	4	DTR	Rx-	Rx-
	5	GND	GND	GND
	6	DSR		
	7	RTS		
	8	CTS		
	9	RI		

Signal Name	Description
DCD	Data Carrier Detect
RxD	Receive Data sends data to the communications link (straight-through connection)
TxD	Transmitted Data sends data to the communications link (straight-through connection)
DTR	Data Terminal Ready indicates that the on-board UART is ready to establish communication link.
DSR	Data Set Ready, indicates that the modem etc. is ready to establish a communications link.
RTS	Request To Send, indicates to the modem etc. that the on-board UART is ready to
CTS	Clear to send
RI	Ring Indicator, indicates that the modem has received a ringing signal from the telephone line.
TX+/-	Transmitted Data differential pair sends data to the communications link.
RX+/-	Received Data differential pair receives data from the communications link.
GND	GND signal

12.2.7. 8-Channel GPIO/DIO Connector (X231)

Table 44: GPIO/DIO Connector Pin Assignment

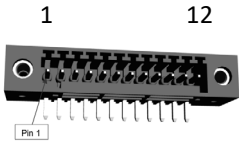
12-pin GPIO Connector	Pin	Signal Name	Direction	Description
	1	PWR_IN	Power	Power Input 10 V to 30 V (Power Inputs fused with 3A)
	2	PWR_IN	Power	
	3	NC		
	4	GPIO1	In/Out	GP Input /Output Channel
	5	GPIO2	In/Out	
	6	GPIO3	In/Out	
	7	GPIO4	In/Out	
	8	GPIO5	In/Out	
	9	GPIO6	In/Out	
	10	GPIO7	In/Out	
	11	GPIO8	In/Out	
	12	GND	Ground	Ground connected directly to system chassis (shield)
Mating Connector	691381030012 WR-TBL Serie 381 Würth Elektronik or equivalent. Description: 12-pin 2.50 mm vertical CAB entry plug screw less with flanges and Stranded Wire: 24-16 AWG / 0.205-1.31 MM ² .			

12.3. On board Header Pin Assignments

This chapter provides the pin assignment of relevant on-board headers.

12.3.1. RTC Power Input Header

The motherboard RTC lithium battery header connects to the lithium battery. The lithium battery provides power to the system clock to retain the time when the power is switched off.

Table 45: RTC Power Input Header Pin Assignment

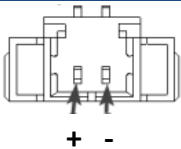
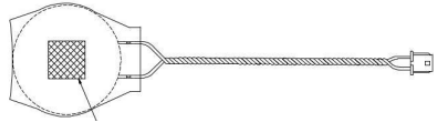
Pins	State	2-pin RTC Power Input Header
1	VBAT +	
2	GND (-)	
Mating Lithium Battery	Red (+)	 (default)
	Black (-)	

13/ BIOS

The KBox A-251 uses the AMI Aptio V uEFI BIOS based on the Unified Extensible Firmware Interface (uEFI) specification and the Intel® Platform Innovation Framework for EFI. The uEFI BIOS preferences are preset and do not require further adjustment for operation.

The UEFI BIOS Setup menus and available selections may vary and are open to change. For specific information on the BIOS for your product, visit Kontron’s [Customer Section](#) to access KBox A-251 information.



UEFI only! No legacy support and no Master Boot Record (MBR) installation.



For the latest uEFI BIOS Information, visit Kontron’s [Customer Section](#).
If the BIOS information you require is not available within the Customer Section, contact [Kontron Support](#).

13.1. Starting the uEFI BIOS

The uEFI BIOS’s Setup program provides quick and easy access to the individual functions within the BIOS sub-menus for control or modification of the uEFI BIOS configuration.

Use the navigation hot keys, to navigate the BIOS. The hot key legend bar is located at the bottom right of each Setup screen. For a list of navigation hot keys, see Table 46: Navigation Hot Keys.

Table 46: Navigation Hot Keys

Sub-screen	Description
<F1>	<F1> key invokes the General Help window
<->	<Minus> key selects the next lower value within a field
<+>	<Plus> key selects the next higher value within a field
<F2>	<F2> key loads previous values
<F3>	<F3> key loads optimized defaults
<F4>	<F4> key Saves and Exits
<←> or <↔>	<Left/Right> arrows select major Setup menus on menu bar, for example, Main or Advanced
<↑> or <↓>	<Up/Down> arrows select fields in the current menu, for example, Setup function or sub-screen
<ESC>	<ESC> key exits a major Setup menu and enters the Exit Setup menu Pressing the <ESC> key in a sub-menu displays the next higher menu level
<RETURN>	<RETURN> key executes a command or selects a submenu

To start the uEFI BIOS Setup program, follow the steps below:

1. Switch on the product.
2. Wait until the first characters appear on the screen (POST messages or splash screen).
3. Press the BIOS access key repeatedly until the BIOS setup screen appears.
4. If the uEFI BIOS is password-protected, a request for password will appear. Enter either the “User Password” or the “Supervisor Password” and press <RETURN>.
5. The BIOS setup utility appears in the Main menu.

6. Use the Navigation Hot Keys arrow keys to navigate to the required Setup menu to “change,” or “reset,” settings.
7. Navigate using Navigation Hot Key arrow keys to the “Save & Exit” Setup menu and select “Save Changes”.

13.2. BIOS Update

To ensure compatibility with new OS, hardware, software or to integrate new BIOS functions Kontron recommends performing regular BIOS updates. Additionally, if a problem cannot be solved using a new driver, Kontron recommends updating the BIOS.

For the latest BIOS downloads and release information, visit Kontron’s [Customer Section](#). Select the latest BIOS Update version and the preferred method to update the BIOS with instructions.



To discover your current BIOS version, refer to the Kontron BIOS Version number within the Main menu.

13.3. Setup Menus

The Setup menus in the products BIOS selection bar are:

- › Main
- › Advanced
- › Chipset
- › Security
- › Boot
- › Save & Exit

The current active menu and active BIOS Setup item are highlighted in white. Use the left and right arrow keys to select the Setup menus.

Each Setup menu is made up of two main frames. The left frame displays all available functions. Configurable functions are displayed in blue. Functions displayed in grey provide information about the status or the operational configuration. The right frame displays an explanation of the respective function in a help window.

Advanced Setup Menu – Caution when Changing

NOTICE

Making changes within the Advanced Setup menu without understanding the full implications may cause system malfunction.

Kontron recommends users to make changes only when the user is sure of the impact.



Functions displayed in “grey” in the following setup menus and tables provide information about the status or the operational configuration of the product but are not selectable and not changeable.

13.4. Main Setup Menu

The Main Setup menu provides basic system information and functions for setting the system time and date. The Main Setup menu example is based on the KBox A-251-AML/ADN, with 2.5"-SBC-AML/ADN board.

Figure 27: Main Setup Menu Example

Aptio Setup - AMI					
Main	Advanced	Chipset	Security	Boot	Save & Exit
Product Information					
Product Name		2.5-SBC-ADN_AML			
BIOS Information					
BIOS Vendor		American Megatrends			
Core Version		5.27			
Compliance		UEFI 2.8 ; Pi 1.7			
Kontron BIOS Version (KBox251ADN110)		ADNUPXR.140 (x64)			
Access Level		Administrator			
FPS Information					
FSP version		0C.02.89.40			
RC version		0C.E0.89.40			
Build Date					
FSP Mode		Dispatch Mode			
Processor Information					
Name		AlderLake ULX			
Type		Intel® Core™ I3-N305			
Speed		1800 MHz			
ID		0xB06E0			
Stepping		A0			
Package		Not Implemented Yet			
Number of Efficient-cores		8Core(s) / 8Thread(s)			
Microcode Revision		18			
GT Info		0x46D0			
IGFX GOP Version		21.0.1063			
Memory RC Version		0.0.4.74			
Total Memory		7936 MB			
Memory Frequency		3600 MHz			
PCH Information					
Name		PCH-N			
PCH SKU		N Premium SKU			
Stepping		A0			
ChipsetInit Base Revision		4			
ChipsetInit OEM Revision		0			

Aptio Setup - AMI					
Main	Advanced	Chipset	Security	Boot	Save & Exit
Package		Not Implemented Yet			
TXT Capability of Plattform/PCH		Unsupported			
Production Type		Production			
Dual Output Fast Read support		Supported			
Read ID/Status Clock Freq		50 MHz			
Write and Erase Clock Freq		50 MHz			
Fast Read Clock Freq		50 MHz			
Fast Read support		Supported			
Number of Components		1 Component			
SPI Component 0 Density		32 MB			
eSPI Flash Sharing Mode		G3			
EC PECl Mode		Legacy PECl mode			
ME FW Version		16.50.12.1453			
ME Firmware SKU		Consumer SKU			
PMC FW Version		160.50.0.1010			
System Language		[English]			
▶ Platform Information					
Platform ID					
Board Information		Board Information			
Product Name		Product Name			
UUID		XXXXXXXX-XXXX-XXXX-XXXX-XXXXXXXXXXXX			
KSC Information					
Board Information		Board Information			
Controller		KSC Main Controller			
Operating Mode		Normal			
Board Name		2.5-ADN_AML			
Platform ID		000B			
KSC Spec. Version		1.20			
BIOS Protocol Version		2.3.1			
BIOS SW Spec. Version		1.18			→ ←: Select Screen
Core Firmware Version		1.4.1 Release			↑ ↓: Select Item
Board Firmware Version		1.0.0 Release			Enter: Select
SCM Info		DB-8C-26-E2			+/-: Change Opt.
Boot counter		N/A			F2: Previous Values
					F3: Optimized Defaults
System Date		xxx xx/xx/xxxx			F4: Save & Reset
System Time		xx:xx:xx			ESC: Exit

13.5. Advances Setup Menu

The Advanced Setup menu example is based on the KBox A-251-AML/ADN, with 2.5"-SBC-AML/ADN board.

Figure 28: Advances Setup Menu Example

Aptio Setup - AMI					
Main	Advanced	Chipset	Security	Boot	Save & Exit
Configurable TDP Mode		[15 W]			
In-Band ECC Support		[Enabled]			
Compliance Test Mode		[Disabled]			
HD Audio		[Enabled]			
Power Mode Selection		AT Mode			
ME FW Image Re-Flash		[Disabled]			
Intel® TCC Mode		[Disabled]			
▶ Display Configuration					
▶ Trusted Computing					
▶ ACPI Settings					
▶ Miscellaneous					
▶ H/W Monitor					
▶ S5 RTC Wake Settings					
▶ Serial Port Console Redirection					
▶ SIO Configuration					
▶ USB Configuration					
▶ Network Stack Configuration					
▶ NVME Configuration					
▶ SDIO Configuration					
▶ eDP Configurations					
▶ COM Configurations					
Intel® Ethernet Controller I226-V – XX:XX:XX:XX:XX:XX					
Intel® Ethernet Controller I226-V – XX:XX:XX:XX:XX:XX					
				→ ←: Select Screen	
				↑ ↓: Select Item	
				Enter: Select	
				+/-: Change Opt.	
				F1: General Help	
				F2: Previous Values	
				F3: Optimized Defaults	
				F4: Save & Reset	
				ESC: Exit	

The following tables gives more information about important setup options within the Advanced Menu.

Advanced Setup Menu – Caution when Changing

NOTICE

Making changes within the Advanced Setup menu without understanding the full implications may cause system malfunction.

Kontron recommends users to make changes only when the user is sure of the impact.

Table 47: Advanced Setup Menu Sub-screens Example

Sub-screen	BIOS Default	Possible Settings
Configurable TDP Boot Mode	15W	15W, 9W, Deactivate
In-Band ECC Support	Enabled	Disabled, Enabled
Compliance Test Mode	Disabled	Disabled, Enabled
HD Audio	Enabled	Disabled, Enabled
Power Mode Selection	ATX Mode	
ME FW Image Re-Flash	Disabled	Disabled, Enabled
Intel® TCC Mode	Disabled	Disabled, Enabled

Display Configuration

Sub-screen	BIOS Default	Possible Settings
Display Configuration		
VBT Select	DP	DP, HDMI
Primary Display	IGFX	Auto, IGFX, PEG Slot; PCH PCI
Internal Graphics	Enabled	
Aperture Size	256MB	128MB, 256MB, 512MB, 1024MB

Trusted Computing

Sub-screen	BIOS Default	Possible Settings
TPM 2.0 Device Found		
Firmware Version	16.13	
Vendor	IFX	
Security Device Support	Enable	Disabled, Enable
Active PCR banks	SHA256	
Available PCR banks	SHA256,SHA384	
SHA256 PCR Bank	Enabled	Disabled, Enabled
SHA384 PCR Bank	Disabled	Disabled, Enabled
Pending Operation	None	None, TPM Clear
Platform Hierarchy	Enabled	Disabled, Enabled
Storage Hierarchy	Enabled	Disabled, Enabled
Endorsement Hierarchy	Enabled	Disabled, Enabled
Physical Presence Spec Version	1.3	1.2, 1.3

Sub-screen	BIOS Default	Possible Settings
TPM 2.0 InterfaceType	TIS	
Device Select	Auto	TPM 1.2, TPM 2.0, Auto

ACPI Settings

Sub-screen	BIOS Default	Possible Settings
ACPI Settings		
Enable ACPI Auto Configuration	Disabled	Disabled, Enabled
Enable Hibernation	Enabled	Disabled, Enabled
ACPI Sleep State	S3 (Suspend to RAM)	Suspend Disabled, S3 (Suspend to RAM)

Miscellaneous

Sub-screen	BIOS Default	Possible Settings
Miscellaneous Configuration		
▶ Present DIO in BIOS		
GPIO OS usable	GPIO 0 – GPIO 7	
Control DIO in BIOS	Disabled	
▶ Control KSC firmware		
Lock FW update access	Enabled	Disabled, Enabled
▶ KSC OTP area control		
KSC OTP access control	Enabled	Disabled, Enabled
▶ Update KSC firmware		
Auto update KSC FW	Disabled	Disabled, Enabled
▶ Generic eSPI Decode Rangers		
Generic LPC via eSPI Decode 1	Disabled	Disabled, Enabled
▶ Watchdog		
Auto-reload	Disabled	Disabled, Enabled
Global Lock	Disabled	Disabled, Enabled
WDT Strobe	Disabled	Disabled, Enabled
Stage 1 Mode	Disabled	Disabled, Reset, Delay, WDT Signal only
Reset Button Behavior	Chipset Reset	Chipset Reset, Power Cycle
I2C Speed	100 KHz	100 KHz, 400 KHz, 1 MHz
Onboard I2C Mode	Multimaster	Multimaster, Busclear
BIOS Test Mode	Disabled	

Sub-screen	BIOS Default	Possible Settings
Last system reset through	Power-on reset	
Create GSPI ACPI dev	Disabled	Disabled, Kontron Linux BSP, Win10 RhProxy style
PCIe Wake	Enabled	Disabled, Enabled
Onboard EEPROM Write Protect	WP Enabled	WP Disabled, WP Enabled

H/W Monitor

Sub-screen	BIOS Default	Possible Settings
KSC based H/W Monitor		
Temperature sensors:		
#1: CPU Temp	x xxx.x C	
#2: PCH Temp	x xxx.x C	
#3: System Temp	x xxx.x C	
Voltage sensors:		
#1: V_IN	xx.x V	
#1: 12V_S0	xx.x V	
#1: 5V_S0	xx.x V	
#1: 3V3_S0	xx.x V	
#1: 3V_BAT	xx.x V	
Fan speed & control:		

S5 RTC Wake Settings

Sub-screen	BIOS Default	Possible Settings
Wake system from S5	Disabled	Disabled, Fixed Time, Dynamic Time

Serial Port Console redirection (COM1, COM2, EMS)

Sub-screen	BIOS Default	Possible Settings
COM1		
Console Redirection	Disabled	Disabled, Enabled
▶ Console Redirection Settings		
Terminal Type	ANSI	VT100, VT100Plus, VT-UTF8, ANSI
Bits per second	115200	9600, 19200, 38400, 57600, 115200
Data Bits	8	7, 8

Sub-screen	BIOS Default	Possible Settings
Parity	None	None, Even, Odd, Mark, Space
Stop Bits	1	1, 2
Flow Control	None	None, Hardware RTS/CTS
CT-UTF8 Combo Key Support	Enabled	Disabled, Enabled
Recorder Mode	Disabled	Disabled, Enabled
Resolution 100x31	Disabled	Disabled, Enabled
Putty KeyPad	VT100	VT100, LINUX, XTERMR6, SCO, ESCN, VT400
COM2		
Console Redirection	Disabled	Disabled, Enabled
▶ Console Redirection Settings	xx.x V	
Terminal Type	ANSI	VT100, VT100Plus, VT-UTF8, ANSI
Bits per second	115200	9600, 19200, 38400, 57600, 115200
Data Bits	8	7, 8
Parity	None	None, Even, Odd, Mark, Space
Stop Bits	1	1, 2
Flow Control	None	None, Hardware RTS/CTS
CT-UTF8 Combo Key Support	Enabled	Disabled, Enabled
Recorder Mode	Disabled	Disabled, Enabled
Resolution 100x31	Disabled	Disabled, Enabled
Putty KeyPad	VT100	VT100, LINUX, XTERMR6, SCO, ESCN, VT400
Serial Port for Out-of-Band Management / Windows Emergency Management Services (EMS)		
Console Redirection	Disabled	Disabled, Enabled
▶ Console Redirection Settings		
Out-of-Band Mgmt Port	COM1	COM1, COM2
Terminal Type EMS	VT-UTF8	VT100, VT100Plus, VT-UTF8, ANSI
Bits per second EMS	115200	9600, 19200, 57600, 115200
Flow Control EMS	None	None, Hardware RTS/CTS
Data Bits EMS	8	
Parity EMS	None	
Stop Bits EMS	1	

SIO Configuration (Serial port 0, Serial port 1)

Sub-screen	BIOS Default	Possible Settings
AMI SIO Driver Version: A5.19.00		
WARNING: Logical Device state on the left side of the control reflects the current Logical Device state. Changes made during Setup Session will be shown after you restart the system.		
Super IO Chip Logical Device(s) Configuration		
▶ [*Active*] Serial Port 0		
Use This Device	Enabled	Disabled, Enabled
Logical Device Settings:		
Current: IO=3F8h; IRQ=4;		
Possible:	Use Automatic Settings	Use Automatic Settings IO=3F8h; IRQ=4 IO=3F8h; IRQ=4 IO=2F8h; IRQ=3
Warning: Disabling SIO Logical Device may have unwanted side effects. PROCEED WITH CAUTION.		
▶ [*Active*] Serial Port 1		
Use This Device	Enabled	Disabled, Enabled
Logical Device Settings:		
Current: IO=3F8h; IRQ=4;		
Possible:	Use Automatic Settings	Use Automatic Settings IO=3F8h; IRQ=4 IO=3F8h; IRQ=4 IO=2F8h; IRQ=3
Warning: Disabling SIO Logical Device may have unwanted side effects. PROCEED WITH CAUTION.		

USB Configuration

Sub-screen	BIOS Default	Possible Settings
USB configuration		
USB Module Version 32		
USB Controllers:		
2 XHCIs		
USB Devices:		
xxxxxxx		

Sub-screen	BIOS Default	Possible Settings
Legacy USB Support	Enabled	Disabled, Enabled, Auto
XHCI Hand-off	Enabled	Disabled, Enabled
USB Mass Storage Driver Support	Enabled	Disabled, Enabled
USB hardware delays and time-outs:		
USB transfer time-out	20 sec	1 sec, 5 sec, 10 sec, 20 sec
Device reset time-out	20 sec	10 sec, 20 sec, 30 sec, 40 sec
Device power-up delay	Auto	Auto, Manuel

Network Stack Configuration

Sub-screen	BIOS Default	Possible Settings
Network Stack	Disabled	Disabled, Enabled
IPv4 PXE Support	Disabled	Disabled, Enabled
IPv4 HTTP Support	Disabled	Disabled, Enabled
IPv6 PXE Support	Disabled	Disabled, Enabled
IPv6 HTTP Support	Disabled	Disabled, Enabled
PXE boot wait time	0	0-5
Media detect count	1	1-50

NVME Configuration

Sub-screen	BIOS Default	Possible Settings
NVMe Configuration		
No NVME Device Found		

SDIO Configuration

Sub-screen	BIOS Default	Possible Settings
SDIO Configuration		
SDIO Access Mode	Auto	Auto, ADMA, SDMA, PIO
Mass Storage Devices:		
Bus 0 Dev 1A Func 0		
eMMC 0WM20G(xxx.xGB)	Auto	Auto, Floppy, Forced FDD, Hard Disk

eDP Configurations

Sub-screen	BIOS Default	Possible Settings
eDP Configurations		
Backlight Source Selection	Controlled by PCH	Controlled by PCH Controlled by EC

COM Configurations

Sub-screen	BIOS Default	Possible Settings
COM Configurations		
COM1 Mode Selection	RS232	RS422 Single Master, RS232, RS485 with Auto Flow Control, RS422 Multi Master
COM1 Transceiver	Normal mode	Shut down mode, Normal mode
COM1 Internal Terminator Switch Control	Terminator switch disabled.	Terminator switch is disabled. Terminator switch is enabled.
COM1 External Terminator Switch Control	Terminator switch disabled.	Terminator switch is disabled. Terminator switch is enabled.
COM2 Mode Selection	RS232	RS422 Single Master, RS232, RS485 with Auto Flow Control, RS422 Multi Master
COM2 Transceiver	Normal mode	Shut down mode, Normal mode
COM2 Internal Terminator Switch Control	Terminator switch disabled.	Terminator switch is disabled. Terminator switch is enabled.
COM2 External Terminator Switch Control	Terminator switch disabled.	Terminator switch is disabled. Terminator switch is enabled.

Intel Ethernet Controller i226-V

Sub-screen	BIOS Defaults	Possible Setting
UEFI Driver	Intel® 2.5G Ethernet Controller 0.10.06	
Device Name	Intel® Ethernet Controller I226-V	
Link Status	Disconnected	
MAC Address	XX:XX:XX:XX:XX:XX	

Intel Ethernet Controller i226-V

Sub-screen	BIOS Defaults	Possible Setting
UEFI Driver	Intel® 2.5G Ethernet Controller 0.10.06	
Device Name	Intel® Ethernet Controller I226-V	
Link Status	Disconnected	
MAC Address	XX:XX:XX:XX:XX:XX	

13.6. Chipset Menu

The Chipset Setup menu example is based on the KBox A-251-AML/ADN, with 2.5"-SBC-AML/ADN board.

Figure 29: Chipset Menu Example

Aptio Setup - AMI					
Main	Advanced	Chipset	Security	Boot	Save & Exit
<ul style="list-style-type: none"> ▶ System Agent (SA) Configurations ▶ PCH-IO Configuration 					
				→ ←: Select Screen ↑ ↓ : Select Item Enter: Select +/-: Change Opt. F1: General Help F2: Previous Values F3: Optimized Defaults F4: Save & Reset ESC: Exit F4: Save & Reset	

The following table gives more information about important setup options within the Chipset Menu.

Table 48: Chipset Setup Menu Sub-screens Example

System Agent (SA) Configuration

Sub-screen	BIOS Defaults	Possible Setting
System Agent (SA) Configuration		
VT-D	Supported	
▶ Graphics Configuration		
Graphics Turbo IMON Current	31	14-31
Skip Scanning of External Gfx Card	Disabled	Disabled, Enabled
▶ External Gfx Card Primary Display Configuration		
External Gfx Card Primary Display Configuration		
GTT Size	8MB	2MB, 4MB, 8MB
PSMI SUPPORT	Disabled	Disabled, Enabled
Intel Graphics Pei Display Peim	Disabled	Disabled, Enabled

Sub-screen	BIOS Defaults	Possible Setting
VDD Enable	Enabled	Disabled, Enabled
Configure GT for use	Enabled	Disabled, Enabled
RC1p Support	Disabled	Disabled, Enabled
PAVP Enable	Enabled	Disabled, Enabled
Cdynmax Clamping Enable	Disabled	Disabled, Enabled
Cd Clock Frequency	Max CdClock freq based on Reference Clk	192 Mhz, 307.2 Mhz, 556.8 Mhz, 652.8 Mhz, Max CdClock freq based on Ref. Clk
Enable Display Audio Link in Pre-OS	Disabled	Disabled, Enabled
IUER Button Enable	Disabled	Disabled, Enabled
▶ LCD Control		
LCD Panel Type	VBIOS Default	VBIOS Default 640x480 LVDS 800x600 LVDS 1024x768 LVDS 1280x1024 LVDS 1400x1050 LVDS 1400x1050 LVDS 1600x1200 LVDS 1280x768 LVDS 1280x1050 LVDS 1680x1050 LVDS 1920x1200 LVDS 1600x900 LVDS 1280x800 LVDS 1280x600 LVDS 2048x1536 LVDS 1366x768 LVDS
Panel Scaling	Auto	Auto, Off, Force Scaling
Backlight Control	PWM Normal	PWM Inverted, PWM Normal
Active LFP	eDP Port-A	No eDP, eDP Port-A
Panel Color Depth	18 Bit	18 Bit, 24 Bit
Backlight Brightness	255	255
▶ Intel® Ultrabook Event Support		
IUER Slate Enable	Disable	Disabled, Enabled
IUER Dock Enable	Disable	Disabled, Enabled
VT-d	Enabled	Disabled, Enabled
Above 4GB MMIO BIOS	Enabled	Disabled, Enabled

PCH-IO Configuration

Sub-screen	BIOS Defaults	Possible Setting
PCH-IO Configuration		
▶ PCI Express Configuration		
DMI Link ASPM Control	Auto	Disabled, L0s, L1, L0L1, Auto
Port8xh Decode	Disabled	Disabled, Enabled
PCIe function swap	Enabled	Disabled, Enabled
PCH PCIE Clock Gating	Disabled	Disabled, L0s, L1, L0L1, Auto
PCH PCIE Power Gating	Disabled	Disabled, L0s, L1, L0L1, Auto
▶ PCIe EQ settings		
PCIe EQ override	Disabled	Disabled, Enabled
PCI Express Root Port 1	Lane configured as USV/SATA/UFS	
PCI Express Root Port 2	Lane configured as USV/SATA/UFS	
PCI Express Root Port 3	Lane configured as USV/SATA/UFS	
▶ PCI Express Root Port 4		
PCI Express Root Port 4	Enabled	Disabled, Enabled
Connection Type	Slot	Built-in, Slot
ASPM	Auto	Disabled, L1, Auto
L1 Substates	L1.1 & L1.2	Disabled, L1.1, L1.1 & L1.2
L1 Low	Enabled	Disabled, Enabled
ACS	Enabled	Disabled, Enabled
PTM	Enabled	Disabled, Enabled
DPC	Disabled	Disabled, Enabled
EDPC	Enabled	Disabled, Enabled
URR	Disabled	Disabled, Enabled
FER	Disabled	Disabled, Enabled
NFER	Disabled	Disabled, Enabled
CER	Disabled	Disabled, Enabled
SEFE	Disabled	Disabled, Enabled
SENF	Disabled	Disabled, Enabled
SECE	Disabled	Disabled, Enabled

Sub-screen	BIOS Defaults	Possible Setting
PME SCI	Enabled	Disabled, Enabled
Hot Plug	Disabled	Disabled, Enabled
Advanced Error Reporting	Enabled	Disabled, Enabled
PCIe Speed	Auto	Auto, Gen1, Gen2, Gen3
Transmitter Half Swing	Disabled	Disabled, Enabled
Detect Timeout	0	0-65535
Extra Bus Reserved	0	0-7
Reserved Memory	10	1-20
Reserved I/O	4	4-20
PCH PCIe LTR Configuration		
LTR	Enabled	Disabled, Enabled
Snoop Latency Override	Auto	Disabled, Manual, Auto
Non Snoop Latency Override	Auto	Disabled, Manual, Auto
LTR Lock	Disabled	Disabled, Enabled
Peer Memory Write Enable	Disabled	Disabled, Enabled
PCI Express Root Port 5	Not present in this SKU	
PCI Express Root Port 6	Not present in this SKU	
▶ PCI Express Root Port 7		
PCI Express Root Port 7	Enabled	Disabled, Enabled
Connection Type	Slot	Built-in, Slot
ASPM	Auto	Disabled, L1, Auto
L1 Substates	L1.1 & L1.2	Disabled, L1.1, L1.1 & L1.2
L1 Low	Enabled	Disabled, Enabled
ACS	Enabled	Disabled, Enabled
PTM	Enabled	Disabled, Enabled
DPC	Disabled	Disabled, Enabled
EDPC	Enabled	Disabled, Enabled
URR	Disabled	Disabled, Enabled

Sub-screen	BIOS Defaults	Possible Setting
FER	Disabled	Disabled, Enabled
NFER	Disabled	Disabled, Enabled
CER	Disabled	Disabled, Enabled
SEFE	Disabled	Disabled, Enabled
SENF	Disabled	Disabled, Enabled
SECE	Disabled	Disabled, Enabled
PME SCI	Enabled	Disabled, Enabled
Hot Plug	Disabled	Disabled, Enabled
Advanced Error Reporting	Enabled	Disabled, Enabled
PCIe Speed	Auto	Auto, Gen1, Gen2, Gen3
Transmitter Half Swing	Disabled	Disabled, Enabled
Detect Timeout	0	0-65535
Extra Bus Reserved	0	0-7
Reserved Memory	10	1-20
Reserved I/O	4	4-20
PCH PCIe LTR Configuration		
LTR	Enabled	Disabled, Enabled
Snoop Latency Override	Auto	Disabled, Manual, Auto
Non Snoop Latency Override	Auto	Disabled, Manual, Auto
LTR Lock	Disabled	Disabled, Enabled
Peer Memory Write Enable	Disabled	Disabled, Enabled
PCI Express Root Port 8	Not present in this SKU	
▶ PCI Express Root Port 9		
PCI Express Root Port 9	Enabled	Disabled, Enabled
Connection Type	Slot	Built-in, Slot
ASPM	Auto	Disabled, L1, Auto
L1 Substates	L1.1 & L1.2	Disabled, L1.1, L1.1 & L1.2
L1 Low	Enabled	Disabled, Enabled
ACS	Enabled	Disabled, Enabled

Sub-screen	BIOS Defaults	Possible Setting
PTM	Enabled	Disabled, Enabled
DPC	Disabled	Disabled, Enabled
EDPC	Enabled	Disabled, Enabled
URR	Disabled	Disabled, Enabled
FER	Disabled	Disabled, Enabled
NFER	Disabled	Disabled, Enabled
CER	Disabled	Disabled, Enabled
SEFE	Disabled	Disabled, Enabled
SENF	Disabled	Disabled, Enabled
SECE	Disabled	Disabled, Enabled
PME SCI	Enabled	Disabled, Enabled
Hot Plug	Disabled	Disabled, Enabled
Advanced Error Reporting	Enabled	Disabled, Enabled
PCIe Speed	Auto	Auto, Gen1, Gen2, Gen3
Transmitter Half Swing	Disabled	Disabled, Enabled
Detect Timeout	0	0-65535
Extra Bus Reserved	0	0-7
Reserved Memory	10	1-20
Reserved I/O	4	4-20
PCH PCIe LTR Configuration		
LTR	Enabled	Disabled, Enabled
Snoop Latency Override	Auto	Disabled, Manual, Auto
Non Snoop Latency Override	Auto	Disabled, Manual, Auto
LTR Lock	Disabled	Disabled, Enabled
Peer Memory Write Enable	Disabled	Disabled, Enabled
PCI Express Root Port 10	Shadowed by x2/x4 port	
▶ PCI Express Root Port 11		
PCI Express Root Port 11	Enabled	Disabled, Enabled
Connection Type	Slot	Built-in, Slot

Sub-screen	BIOS Defaults	Possible Setting
ASPM	Auto	Disabled, L1, Auto
L1 Substates	L1.1 & L1.2	Disabled, L1.1, L1.1 & L1.2
L1 Low	Enabled	Disabled, Enabled
ACS	Enabled	Disabled, Enabled
PTM	Enabled	Disabled, Enabled
DPC	Disabled	Disabled, Enabled
EDPC	Enabled	Disabled, Enabled
URR	Disabled	Disabled, Enabled
FER	Disabled	Disabled, Enabled
NFER	Disabled	Disabled, Enabled
CER	Disabled	Disabled, Enabled
SEFE	Disabled	Disabled, Enabled
SENF	Disabled	Disabled, Enabled
SECE	Disabled	Disabled, Enabled
PME SCI	Enabled	Disabled, Enabled
Hot Plug	Disabled	Disabled, Enabled
Advanced Error Reporting	Enabled	Disabled, Enabled
PCIe Speed	Auto	Auto, Gen1, Gen2, Gen3
Transmitter Half Swing	Disabled	Disabled, Enabled
Detect Timeout	0	0-65535
Extra Bus Reserved	0	0-7
Reserved Memory	10	1-20
Reserved I/O	4	4-20
PCH PCIe LTR Configuration		
LTR	Enabled	Disabled, Enabled
Snoop Latency Override	Auto	Disabled, Manual, Auto
Non Snoop Latency Override	Auto	Disabled, Manual, Auto
LTR Lock	Disabled	Disabled, Enabled
Peer Memory Write Enable	Disabled	Disabled, Enabled
PCI Express Root Port 12	Shadowed by x2/x4 port	

Sub-screen	BIOS Defaults	Possible Setting
▶ PCIe Clocks		
Clock0 assignment	Enabled	Platform-POR, Enabled, Disabled
ClkReq for Clock0	Platform-POR	Platform-POR, Disabled
Clock1 assignment	Enabled	Platform-POR, Enabled, Disabled
ClkReq for Clock1	Platform-POR	Platform-POR, Disabled
Clock2 assignment	Enabled	Platform-POR, Enabled, Disabled
ClkReq for Clock2	Platform-POR	Platform-POR, Disabled
Clock3 assignment	Enabled	Platform-POR, Enabled, Disabled
ClkReq for Clock3	Platform-POR	Platform-POR, Disabled
Clock4 assignment	Enabled	Platform-POR, Enabled, Disabled
ClkReq for Clock4	Platform-POR	Platform-POR, Disabled
Clock5 assignment	Enabled	Platform-POR, Enabled, Disabled
ClkReq for Clock5	Platform-POR	Platform-POR, Disabled
Clock6 assignment	Enabled	Platform-POR, Enabled, Disabled
ClkReq for Clock6	Platform-POR	Platform-POR, Disabled
Clock7 assignment	Enabled	Platform-POR, Enabled, Disabled
ClkReq for Clock7	Platform-POR	Platform-POR, Disabled
Clock8 assignment	Enabled	Platform-POR, Enabled, Disabled
ClkReq for Clock8	Platform-POR	Platform-POR, Disabled
Clock9 assignment	Enabled	Platform-POR, Enabled, Disabled
ClkReq for Clock9	Platform-POR	Platform-POR, Disabled
▶ SATA Configuration		
SATA Controller(s)	Enabled	Disabled, Enabled
SATA Mode Selection	AHCI	AHCI
SATA Test Mode	Disabled	Disabled, Enabled
Aggressive LPM Support	Enabled	Disabled, Enabled
Serial ATA Port 0	Empty	
Software Preserve	Unknown	
Port 0	Enabled	Disabled, Enabled
Hot Plug	Disabled	Disabled, Enabled

Sub-screen	BIOS Defaults	Possible Setting
Configure as eSATA	Hot Plug supported	
External	Disabled	Disabled, Enabled
Spin Up Device	Disabled	Disabled, Enabled
SATA Device Type	Hard Disk Drive	Hard Disk Drive, Solid State Drive
Topology	Unknown	Unknown, ISATA, Direct connect, Flex, M2
SATA Port 0 DevSlp	Disabled	Disabled, Enabled
DITO Configuration	Disabled	Disabled, Enabled
DITO Value	625	
DM Value	15	
Serial ATA Port 1	Empty	
Software Preserve	Unknown	
Port 1	Enabled	Disabled, Enabled
Hot Plug	Disabled	Disabled, Enabled
Configure as eSATA	Hot Plug supported	
External	Disabled	Disabled, Enabled
Spin Up Device	Disabled	Disabled, Enabled
SATA Device Type	Hard Disk Drive	Hard Disk Drive, Solid State Drive
Topology	Unknown	Unknown, ISATA, Direct connect, Flex, M2
SATA Port 1 DevSlp	Disabled	Disabled, Enabled
DITO Configuration	Disabled	Disabled, Enabled
DITO Value	625	
DM Value	15	
Serial ATA Port 2	Empty	
Software Preserve	Unknown	
Port 2	Enabled	Disabled, Enabled
Hot Plug	Disabled	Disabled, Enabled
Configure as eSATA	Hot Plug supported	
External	Disabled	Disabled, Enabled
Spin Up Device	Disabled	Disabled, Enabled
SATA Device Type	Hard Disk Drive	Hard Disk Drive, Solid State Drive
Topology	Unknown	Unknown, ISATA, Direct connect, Flex, M2
SATA Port 2 DevSlp	Disabled	Disabled, Enabled

Sub-screen	BIOS Defaults	Possible Setting
DITO Configuration	Disabled	Disabled, Enabled
DITO Value	625	
DM Value	15	
▶ USB Configuration		
xDCI Support	Disabled	Disabled, Enabled
USB2 PHY Sus Well Power Gating	Enabled	Disabled, Enabled
USB PDO Programming	Enabled	Disabled, Enabled
USB Overcurrent	Enabled	Disabled, Enabled
USB Overcurrent Lock	Enabled	Disabled, Enabled
USB Audio Offload	Enabled	Disabled, Enabled
USB Enable HSII on xHCI	Enabled	Disabled, Enabled
USB3.1 Portx Speed Selection	0	0-15
USB Port Disable Override	Disable	Disable, Select Per-Pin
▶ TSN GBE Configuration		
PCH LAN Controller	No GbE Region	
Port 80h Redirection	LPC Bus	LPC Bus, PCIE Bus
Enhance Port 80h LPC Decoding	Enabled	Disabled, Enabled
PCH LAN Controller	Disabled	

Sub-screen	BIOS Default	Possible Settings
▶ Key Management		
Vendor Keys	Valid	
Factory Key Provision	Disabled	Disabled, Enabled
▶ Restore Factory Keys		
▶ Reset to Setup Mode		
▶ Enroll Efi Image		
▶ Export Secure Boot variables		
Secure Boot variable		
▶ Platform Key (PK)		
▶ Key Exchange Keys		
▶ Authorized Signatures		
▶ Forbidden Signatures		
▶ Authorized TimeStamps		
▶ OsRecovery Signatures		



UEFI only! No legacy support and no Master Boot Record (MBR) installation.

13.8. Boot Setup Menu

The Boot Setup menu example is based on the KBox A-251-AML/ADN, with 2.5"-SBC-AML/ADN board.

Figure 31: Boot Setup Menu Example

Aptio Setup - AMI					
Main	Advanced	Power	Boot	Security	Save & Exit
Boot Configuration Setup Prompt Timeout [1] Bootup NumLock State [On] Quiet Boot [Cold Reset] Fixed Boot order [Enabled] Boot Option Priorities Boot Option #1 [xxxxx] ► UEFI Hard Disk Drive BBS Priorities ► UEFI Application Boot Priorities					
				→ ←: Select Screen ↑ ↓: Select Item Enter: Select +/-: Change Opt. F1: General Help F2: Previous Values F3: Optimized Defaults F4: Save & Reset ESC: Exit	

The following table gives more information about important setup options within the Boot menu.

Table 50: Boot Setup Menu Sub-screens Example

Sub-screen	BIOS Default	Possible Settings
Boot Configuration		
Setup Prompt Timeout	1	Displays number of seconds the firmware waits for setup activation key. (65535 (0xFFFF) means an indefinite wait) 1-65535
Bootup NumLock State	On	On, Off
Quiet Boot	Disable	Disabled, Enabled
Fixed Boot Order	Enabled	Disabled, Enabled
Boot Option Priorities		
Boot Option #1	XXXXXX	
► UEFI Hard Disk Drive BBS Priorities		
Boot Option #1	XXXXXX	
► UEFI Application Boot Priorities		
Boot Option #1	UEFI: Built-in EFI Shell	UEFI: Built-in EFI Shell Disabled

13.9. Save and Exit Setup Menu

The Save and Exit Setup menu example is based on the KBox A-251-AML/ADN, with 2.5"-SBC-AML/ADN board.

Figure 32: Save and Exit Setup Menu Example

Aptio Setup - AMI					
Main	Advanced	Power	Boot	Security	Save & Exit
Save Options					
Save Changes and Exit					
Discard Changes and Exit					
Save Changes and Reset					
Discard Changes and Reset					
Save Changes					
Discard Changes					
Default Options				→ ←: Select Screen	
Restore Defaults				↑ ↓: Select Item	
Save as user Default				Enter: Select	
Restore user Defaults				+/-: Change Opt.	
Boot Override				F1: General Help	
UEFI: Built-in EF Shell				F2: Previous Values	
XXXXX				F3: Optimized Defaults	
				F4: Save & Reset	
				ESC: Exit	

The following table gives more information about important setup options within the Save and Exit Menu.

Table 51: Save and Exit Setup Menu Sub-screens Example

Sub-screen	Description
Save Changes and Exit>	Exits system after saving changes
Discard Changes and Exit>	Exits system setup without saving changes
Save Changes and Reset>	Reset system after saving changes
Discard Changes and Reset>	Resets system setup without saving changes
Save Changes>	Saves changes made so far for any setup options
Discard Changes>	Discards changes made so far to the setup values and restore the previously saved values.
Restore Defaults>	Restores/loads standard default values for all setup options
Save as User Defaults>	Saves changes made so far as user defaults
Restore User Defaults>	Restores user defaults to all setup options
UEFI Built-in EFI shell>	Attempts to launch the built in EFI Shell

14/ Maintenance and Prevention

Maintenance or repair on the KBox A-251 may only be carried out by skilled personnel authorized by Kontron. Kontron products require only minimum servicing and maintenance for problem-free operation. Read the observe the warnings within this chapter before performing maintenance on the product.

Handling the Product

CAUTION

Handling and operation of the product is permitted only for skilled personnel aware of the associated dangers, within an access-controlled workplace that fulfills all necessary technical and environmental requirements.

Switch Off Properly!

CAUTION

Even when switched off using the power button, parts of the product are still energized. The product is only completely switched off when the power has been switched off using the power button and the power cable is disconnected from the Power IN connector.

Hot Surface



Heatsinks can get very hot. To avoid burns and personal injury when handling the heatsink:

- › Do not touch while in operation
- › Allow to cool before handling
- › Wear protective gloves



ESD Sensitive Device!

Follow the safety instructions for components that are sensitive to electrostatic discharge (ESD). Failure to observe this warning notice may result in damage to the product or/and internal components.

NOTICE

Protection Label

The product is factory configured to meet customer requirements and then sealed with a protection label. Opening the product invalidates the warranty.

NOTICE

Return to Kontron

Kontron recommends users to return the product to Kontron to avoid damage during maintenance. For more information, see Chapter 15.1: Returning Defective Merchandise.

14.1. Cleaning

The heatsink can get very hot. Take precautions before handling or touching the heatsink to clean the product. Kontron recommends cleaning the heatsink to improve the heatsink's heat dissipation to the ambient environment.



Hot Surface

Heatsinks can get very hot. To avoid burns and personal injury when handling the heatsink:

- › Do not touch while in operation
- › Allow to cool before handling
- › Wear protective gloves

To clean the surface of the product, perform the following:

1. Close all applications. Shut down properly using the power button and disconnect the power cable from the Power IN connector or the DC power supply. Disconnect all peripherals.
2. Allow the product to cool before handling and do not touch the heatsink when the product is in operation.
3. Carefully remove dust using a clean, soft brush and if lightly soiled, clean the product with a dry cloth.
4. Remove stubborn dirt using mild detergent and a soft cloth.

14.2. Replacing the RTC Lithium Battery

An empty RTC lithium battery BIOS does not affect the BIOS settings. However, the system time and date are affected and must be reconfigured after replacing the battery. The RTC lithium battery BR2032 with cable must be replaced with an identical three Volt lithium battery or a Kontron recommended lithium battery, see Table 3: Accessories and Spare Parts.

For replacement or installation, Kontron recommends returning the product to Kontron, see Chapter 15.1: Returning Defective Merchandise.

⚠ CAUTION

Danger of Explosion if lithium battery incorrectly placed!

- Replace only with the same or equivalent type recommended by the manufacturer
- Dispose of used batteries according to the manufacturer's instructions



When booting after replacing the RTC lithium battery, the boot time is longer, as the board performs several reboots before startup.



Do not dispose of lithium batteries in general trash collection. Dispose of the lithium battery according to the local regulations dealing with the disposal of these special materials, (e.g. to the collecting points for disposal of batteries).

Figure 33: RTC Lithium Battery and Battery Header

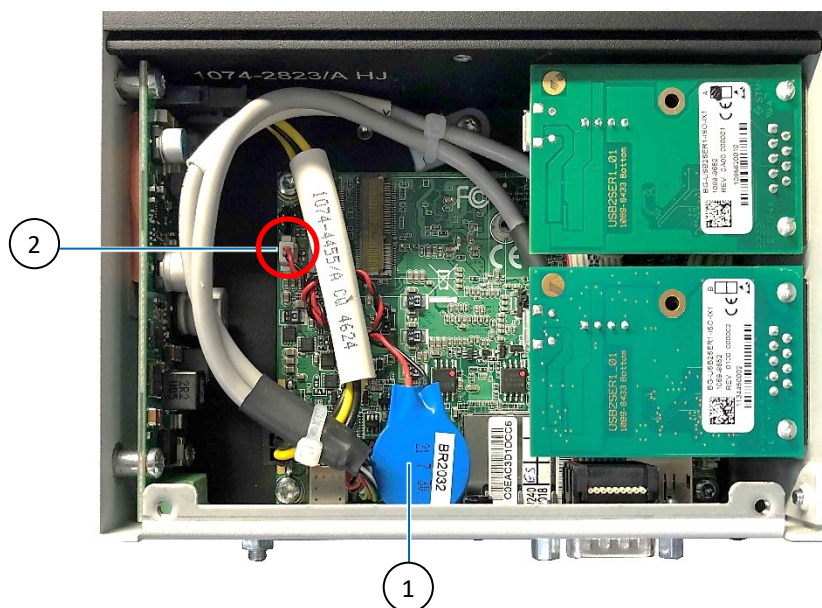

1 BR2032 RTC Lithium battery

2 RTC Power Input Header

To change the RTC lithium battery (BR2032) at the end of the battery lifetime, perform the following:

1. Close all applications. Shut down properly using the power button and disconnect the power cable from the Power IN connector or the DC power supply.
2. Allow the product to cool before handling and do not touch the heatsink until the heatsink has cooled.
3. Place the product on an ESD mat, with the heatsink facing downwards.
4. Remove the two screws fastening the cover plate on the bottom side to the main chassis. Retain the screws for later use.

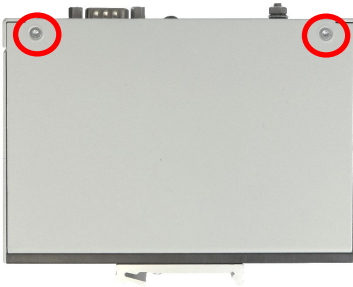

5. Lift the cover plate slightly and slide the cover plate out of the restraining bracket.
6. Remove the lithium battery cable connector from the RTC battery header (Figure 33, pos. 2).
7. Pull the lithium battery firmly to detach the lithium battery's adhesive pad from the internal connector housing (Figure 33, pos. 1).
8. Insert the new lithium battery connector into the battery header. Ensure correct polarity.
9. Attach the new lithium battery to the internal connectors housing using a new adhesive pad.
10. Close the product by proceeding in the reverse order (steps 5 to 4).

14.3. Replacing the Automotive RTC Lithium Battery

An empty automotive RTC lithium battery does not affect the BIOS settings. However, the system time and date are affected and must be reconfigured after replacing the battery. The automotive RTC lithium battery module with BR2450 battery must be replaced with the Kontron spare part, see Table 3: Accessories and Spare Parts.

For replacement or installation, Kontron recommends returning the product to Kontron, see Chapter 15.1: Returning Defective Merchandise.

CAUTION

Danger of Explosion if lithium battery incorrectly placed!

- Replace only with the same or equivalent type recommended by the manufacturer
- Dispose of used batteries according to the manufacturer's instructions



When booting after replacing the automotive RTC lithium battery module, the boot time is longer, as the board performs several reboots before startup.



Do not dispose of lithium batteries in general trash collection. Dispose of the lithium battery according to the local regulations dealing with the disposal of these special materials, (e.g. to the collecting points for disposal of batteries).

Figure 34: Automotive RTC Lithium Battery Module and Battery Header

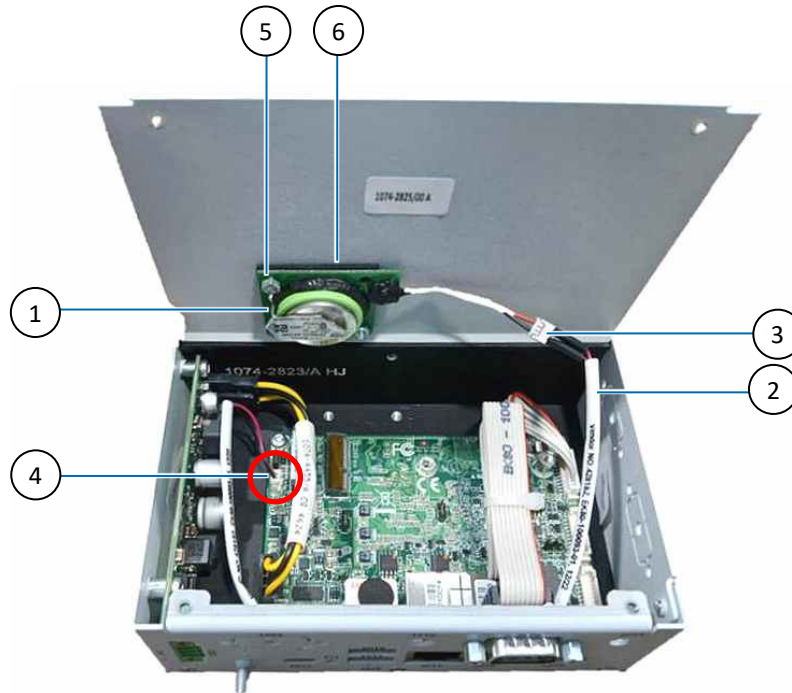

- | | |
|--|--|
| <ul style="list-style-type: none"> 1 Automotive RTC battery module with BR2450 lithium battery and cable 2 Battery extension cable | <ul style="list-style-type: none"> 3 Automotive RTC battery module connection to battery extension cable 4 RTC Power Input Header 5 3x M 2.5 nuts 6 Metal mounting plate |
|--|--|

To change the automotive RTC battery (BR2450) at the end of the battery lifetime, perform the following:

1. Close all applications. Shut down properly using the power button and disconnect the power cable from the Power IN connector or the DC power supply.
2. Allow the product to cool before handling and do not touch the heatsink until the heatsink has cooled.
3. Place the product on an ESD mat, with the heatsink facing downwards.
4. Remove the two screws fastening the cover plate on the bottom side to the main chassis. Retain the screws for later use.

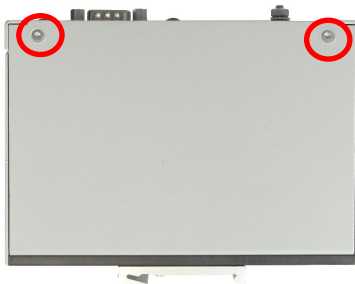

5. Lift the cover plate slightly and slide the cover plate out of the restraining bracket.
6. Place the cover plate on a soft ESD surface facing upwards

7. Remove the automotive RTC battery module's cable from the battery extension cable connector (Figure 34, pos. 3) and remove the battery extension cable from the RTC Power Input Header (Figure 34, pos. 4).
8. Pull the automotive RTC battery module firmly to detach the adhesive pads attaching the automotive RTC battery module to the underside of the cover plate (Figure 34, pos. 1).
9. Prepare the automotive RTC battery module for mounting by inserting the automotive RTC battery module on to the metal plate and securing with the three M 2.5 nuts provided.

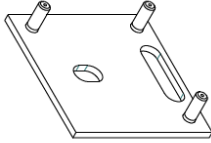

10. Insert the new battery expansion cable into the RTC Power Input Header. Ensure correct polarity.
11. Insert the new automotive RTC battery connector into the battery extension cable. Ensure correct polarity.
12. Attach the adhesive pads provided to the metal plate on the underside of the Automotive RTC battery module and fasten to the underside of the cover plate as shown in Figure 34.
13. Close the product by proceeding in the reverse order (steps 5 to 4).

Adhesive Pad

NOTICE

Only use the adhesive pads provided that have been selected to meet the product requirements under the specified environmental conditions.



Replacement of an automotive RTC battery module does not require replacement of the battery extension cable, unless the battery extension cable is damaged.

14.4. Inserting and Extracting a SIM Card

NOTICE

Switch off to Insert/Extract a SIM card

Only insert or extract the SIM cards if the product is switched off properly.



A SIM card is required only when using the Cellular LTE module and is not part of the delivery and must be provided by the user, to support the required network.

To extract a SIM, perform the following:

1. Close all applications. Shut down properly using the power button and disconnect the power cable from the Power IN connector or the DC power supply.
2. Allow the product to cool before handling or do not touch the heatsink.
3. Push the inserted SIM card slightly to release the card from the SIM slot (X201).
4. Pull the SIM card carefully out of the slot.

To insert a SIM card into the SIM slot on the front panel, perform the following:

1. Close all applications. Shut down properly using the power button and disconnect the power cable from the Power IN connector or the DC power supply.
2. Allow the product to cool before handling or do not touch the heatsink.
3. Insert the SIM card with the terminal contacts facing forwards on the underside, (Figure 22).
4. Push the SIM card carefully into the SIM slot (X201) until the card clicks acoustically.

15/ Technical Support

Should a problem occur, contact Kontron's Support Department:

- › Email: support@kontron.com
- › Phone: +49-821-4086-888

Make sure you have the following information available when you call:

- › Product ID Number (PN)
- › Serial Number (SN)



The serial number can be found on the product's type label.

Be ready to explain the nature of your problem to the service technician.

15.1. Returning Defective Merchandise

All equipment returned to Kontron must have a Return of Material Authorization (RMA) number assigned exclusively by Kontron. Kontron cannot be held responsible for any loss or damage caused to the equipment received without an RMA number. The buyer accepts responsibility for all freight charges for the return of goods to Kontron's designated facility. Kontron will pay the return freight charges back to the buyer's location in the event that the equipment is repaired or replaced within the stipulated warranty period.

Follow these steps before returning any product to Kontron.

Follow these steps before returning any product to Kontron.

1. Visit the RMA Information website: <http://www.kontron.com/support-and-services/support/rma-information>.
2. Download the RMA Request sheet for Kontron Europe GmbH and fill out the form. Take care to include a short, detailed description of the observed problem or failure and to include the product identification Information (Name of product, Product number and Serial number). If a delivery includes more than one product, fill out the above information in the RMA Request form for each product.
3. Send the completed RMA-Request form to the fax or email address given below at Kontron Europe GmbH. Kontron will provide an RMA-Number.
4. Kontron Europe GmbH
RMA Support
Phone: +49 (0) 821 4086-0
Fax: +49 (0) 821 4086 111
Email: service@kontron.com
5. The goods for repair must be packed properly for shipping, considering shock and ESD protection.



Goods returned to Kontron Europe GmbH in non-proper packaging will be considered as customer caused faults and cannot be accepted as warranty repairs.

6. Include the RMA-Number with the shipping paperwork and send the product to the delivery address provided in the RMA form or received from Kontron RMA Support.

16/ Storage and Transportation

16.1. Storage

If the product is not in use for an extended period of time, disconnect the product from the main power supply. If it is necessary to store the product, then repack the product as originally delivered to avoid damage. The storage facility must meet the product's environmental storage requirements as stated within this user guide. Kontron recommends keeping the original packaging material for future storage or warranty shipments.

16.2. Transportation

To ship the product, use the original packaging, designed to withstand impact and adequately protect the product. When packing or unpacking the product, always take shock and ESD protection into consideration and use an EOS/ESD safe working area.

17/ Warranty

Due to their limited service-life, parts that by their nature are subject to a particularly high degree of wear (wearing parts) are excluded from the warranty beyond that provided by law. This applies to the lithium battery, for example.

NOTICE**Protection Label**

The product is factory configured to meet customer requirements and then sealed with a protection label. Opening the product may damage internal components and invalidate the warranty.

18/ Disposal

18.1. Disposal

Dispose of the product in accordance with country, state, or local regulations and requirements as part of your disposal and decommissioning policies or recycle the product or parts of the product for re-use after performing data sanitization to erase sensitive data stored on the product's memory devices.

When disposing of the product

- › Remove any product labels from the product that could indicate ownership and provide a clue to the type of data stored on the memory device.
- › Comply with your company's environmental requirements and the requirements of Waste Electrical and Electronic Equipment (WEEE) directive.
- › Use data sanitization guidelines to ensure that data sensitive to your business and/or confidential or proprietary data and software is removed from the product using a data sanitization method that stops the data from being retrieved or reconstructed.

18.2. WEEE Compliance

The Waste Electrical and Electronic Equipment (WEEE) Directive aims to:

- › Reduce waste arising from electrical and electronic equipment (EEE).
- › Make producers of EEE responsible for the environmental impact of their products, especially when the product becomes waste.
- › Encourage separate collection and subsequent treatment, reuse, recovery, recycling and sound environmental disposal of EEE.
- › Improve the environmental performance of all those involved during the lifecycle of EEE.



Environmental protection is a high priority with Kontron.
Kontron follows the WEEE directive
You are encouraged to return our products for proper disposal.

18.3. Data Sanitization

Data sanitization is the process of permanently erasing or destroying sensitive data on the product's memory devices to prevent unauthorized access to data sensitive to your business and/or confidential/proprietary data stored on the memory devices.

When designing a system, the user must plan for data sanitization and design in memory devices that are easier to sanitize, memory devices from manufactures that provide an effective data erasure tool or a return to factory default command.

When performing data sanitization, the user must consider if the product's memory devices contain sensitive data and develop a data sanitization plan to erase all sensitive data in accordance with country, state, or local data sanitization regulations and requirements or as part of your disposal and decommissioning policies.



Data Sanitization

Users are responsible for erasing sensitive data on memory devices in accordance with country, state, or local data sanitization regulations and requirements, or as part of your disposal and decommissioning policies.

Kontron recommends performing data sanitization when reusing the product in a different user environment, sending the product in for repair, disposing of the product or decommissioning the product.

General guidelines when performing data sanitization on memory devices containing data sensitive to your business and/or confidential/proprietary data:

- › Before powering down, consider if power is required to perform data sanitization on the product's memory devices.
- › When disconnected from the power source, dismantle all removable memory devices from the product and erase sensitive data.
- › Volatile memory devices only store data temporarily. Data on volatile memory can be erased easily by disconnecting the power/removing the battery for approximately 24 hours.
- › Non-volatile memory devices store data permanently and retain information when disconnected from power. Data on non-volatile memory must be actively erased using one of the following methods:
 - › Use an accredited third-party software tool that provides an audit trail, capable of performing a complete data cleaning including areas such as hidden data and bad blocks not accessed by general service-based utilities.
 - › Use the physical destruction methods on memory devices that cannot be securely software erased. The aim of the destruction is to break the silicon die within the chips package into two or more parts to prevent reading data from the die. Fragments should be no longer than 6 mm. If this service is performed by a third party obtain destruction certificates for confirmation.
 - › Use the manufacturer's data erasure tool for sanitization or return to factory default command (if provided by the manufacturer). The manufacturer's tools and commands have been designed to fulfil the data sanitization requirement of the manufacturer's specific memory device(s).
- › Always verify that all sensitive data has been effectively sanitized.



Dismantle Removable Memory

Dismantle all removable memory devices and erase sensitive data for reuse by using:

- › An accredited third-party software tool.
- › Manufacturer's data erasure tool' or 'return to factory default command'. (if provided)
- › If the removable memory is not for reuse, physically destruct the memory according to data sanitization guidelines.



Erase Data

To ensure that forensic tools cannot be used to recover sensitive data:

- › Use an accredited third-party software tool, with an audit trail, capable of performing a complete data clean including areas such as hidden data and bad blocks not accessed by general service-based utilities.
- › Use the manufacturer's data erasure tool or return to factory default command designed to fulfil the data sanitization requirement of the manufacturer's specific memory device(s).



Physical Destruction

When physically destructing the memory:

- › Follow proper safety protocols.
- › Break the chip packaged silicon die into two or more parts, fragments ≤ 6 mm.
- › Check both sides as memory devices may be positioned on the rear side.
- › Use a third-party destruction company providing certificates for confirmation.

18.4. Statement of Memory Volatility

The statement of memory volatility provides the user with a list of the product's standard memory devices and their volatility, to enable the user to develop a suitable data sanitization plan. Note that not all listed memory devices may be part of your delivered product. Some memory devices may be configuration options. Users are responsible for considering the memory devices installed on the product and must take appropriate action to clear the memory if required.

The statement of memory volatility example for the KBox A-251 product is based on the implemented 2.5"-SBC-AML/ADN's Statement of Memory Volatility with the addition of a possible M.2 SSD in the 2.5"-SBC boards M.2 socket and does not include possible system expansion options.



In some cases, special tools and/or software are necessary to access the memory.



The Statement of Memory Volatility example lists the known possible memory devices and due to configuration options may differ from your delivered product and memory sizes may change. This list does not include the system expansion options.

Table 52: Statement of Memory Volatility Example - KBox A-251

Memory Type	Ref. # / Loc.	Memory Size ^[2]	Volatility	Retain Data when Power Off	Alterable in Field ^[1]	Battery Backed Up	Data Type	Write Protected	Emergency Erase	Process to Clear
EMMC										
eMMC5.1 NAND Flash Memory		Up to 128 GB	Non-volatile	No	Yes	No	User Data	No	No	NA
LPDDR										
LPDDR5 SDRAM	SBC Board DDR5 SO-DIMM slot	Up to 16 GB	Volatile	No	Yes	No	User Data	No	No	NA
EC										
Embedded Controller MEC1521		Code Storage: 480 KB (Code + Data) Data RAM: 32 KB	Non-volatile (Code storage) Volatile (RAM)	Yes	Yes	No	Embedded controller config.	Yes	No	Perform EC FW update
CMOS-FLASH SPI MX25V16 35FM2I		16 Mbit	Non-volatile	Yes	Yes	No	EFI Boot	Yes	Yes	Perform BIOS recovery
LAN										
FLASH SPI W25Q16J VSSIQ		16 Mbit	Non-volatile	Yes	Yes	No	EFI Boot	Yes (SW)	No	Perform BIOS recovery

Memory Type	Ref. # / Loc.	Memory Size ^[2]	Volatility	Retain Data when Power Off	Alterable in Field ^[1]	Battery Backed Up	Data Type	Write Protected	Emergency Erase	Process to Clear
BIOS										
FLASH SPI W25Q256J VEIQ		256 Mbit	Non-volatile	Yes	Yes	No	EFI Boot	Yes (SW)	No	Perform BIOS recovery
EEPROM										
EEPROM AT34C04- X5M		4 Kbit	Non-volatile	Yes	Yes	No	Module ID Data	Yes	No	NA
PD										
F75183I		uC internal RAM 256 Byte / Flash ROM Size: 16 KByte	Non-volatile	Yes	No	No	PSC Config.	Yes	No	NA (Board will not operate with modified data)
SPD										
AT34C04- X5M		4 Kbit	Non-volatile	Yes	Yes	No	Module ID Data	Yes	No	NA
VCORE										
MP2964R		8 Kbit	Non-volatile	Yes	No	No	VR Config.	No	No	NA
TPM										
SLB 9672XU2.0		51 KByte	Non-volatile	Yes	Yes	No	User Data	Yes	No	Perform clear item under OS
M.2 Key B Socket										
M.2 Key B 2280 NVME SSD ^[3]	SBC Board M.2 Key B socket	Up to 2 TByte	Non-volatile	Yes	Yes	No	Storage	No	No	Remove from board

^[1] In some cases special tools and/or software are necessary to access the memory.

^[2] Memory size may vary, as over time devices reach EOL or newer higher-density memory devices are introduced.

^[3] This memory type is an option and may not be included in your configuration.

19/ Cyber Security

Cyber security is an important aspect to consider when installing, operating, maintaining and disposing of the product. This chapter provides cyber security guidelines for the user.



Security White Paper

For cyber security guidelines to protect your Kontron product from potential cyber security threats, visit the Kontron Customer Section and refer to Kontron's [Security White paper](#) within General/Security Guidelines.



Security Measures

Kontron is not aware of the final target end user environment in which the product operates. It is not possible for Kontron to provide precise instructions for your cyber security measures. Kontron strives to provide hints for considerations for your threat analysis and to point out particular security mechanisms implemented in Kontron products.

19.1. Security Defense Strategy

When developing your security defense strategy consider implementing the following guidelines to help you effectively secure the product:

- › Policies and procedures developed in association with the product's/end environment's security.
- › Instructions and recommendations for periodic security maintenance activities and reporting product security incidents.
- › Security network controls/setting such as firewall rules.
- › Third party software tools that further protect the product.
- › Authentication to access the product, limit user privileges and managing user accounts.
- › Data encryption.
- › Reduced number of potential security entry points.
- › BIOS/OS and security updates that do not compromise the product's operation or defense in depth strategy.
- › User accounts with length and complexity requirements.
- › Supplied default passwords are changed.
- › Limited network access (IP address range).
- › Installation of anti-virus and malware software.
- › Network access requirements such as VPN.

Appendix: List of Acronyms

ABD	Automated BIOS Description
AC	Alternating Current
BIOS	Basic Input Output System
BMC	Biphase Mark Code
BT®	Bluetooth®
CAN	Controller Area Network
CE	Conformité Européenne
COM	Communication port
DC	Direct Current
DOC	Declaration of Conformity
DP	DisplayPort
DTR	Dynamic Temperature Range
EMC	ElectroMagnetic compatibility
ESD	ElectroStatic Discharge
FCC	Federal Communications Commission
FD	Full Duplex
GbE	Giga Bit Ethernet
GPIO	General Purpose Input Output
HD	High Definition
HD	Half Duplex
HDMI	High Definition Multimedia Interface
IEC	International Electrotechnical Commission
IOT	Internet of Things
LAN	Local Area Network
IP	International Protection
LED	Light Emitting Diode
LPC	Limited Power Source
LTE	Long-Term Evolution
MBR	Master Boot Record
MDI	Media Dependent Interface
MTBF	Mean Time Before Failure
PS	Power Source
PSU	Power Supply Unit
RED	Radio Equipment Directive
RMA	Return of Material Authorization
RoHS	Restriction of Hazardous Substances
RTC	Real Time Clock
RX	Receive

SD card	Secure Digital Card
SIM	Subscriber Identity Module
TNV	Telecommunication Network Voltage
TPM	Trusted Platform Module
TX	Transmit
UEFI	Unified Extensible Firmware Interface
UL	Underwriters Laboratories
USB	Universal Serial Bus



About Kontron

Kontron is a global leader in IoT/Embedded Computing Technology (ECT) and offers individual solutions in the areas of Internet of Things (IoT) and Industry 4.0 through a combined portfolio of hardware, software and services. With its standard and customized products based on highly reliable state-of-the-art technologies, Kontron provides secure and innovative applications for a wide variety of industries. As a result, customers benefit from accelerated time-to-market, lower total cost of ownership, extended product lifecycles and the best fully integrated applications.

For more information, please visit: www.kontron.com

Global Headquarters

Kontron Europe GmbH

Gutenbergstraße 2
85737 Ismaning, Germany
Tel.: +49 8214 4086-0
info@kontron.com

www.kontron.de

