



KBox F-100/110 Series

Doc. User Guide, Rev. 1.1

Doc. ID: [To be Determined]

This page has been intentionally left blank

 KBOX F-100/110 SERIES – USER GUIDE

Disclaimer

Kontron would like to point out that the information contained in this user guide may be subject to alteration, particularly as a result of the constant upgrading of Kontron products. This document does not entail any guarantee on the part of Kontron with respect to technical processes described in the user guide or any product characteristics set out in the user guide. Kontron assumes no responsibility or liability for the use of the described product(s), conveys no license or title under any patent, copyright or mask work rights to these products and makes no representations or warranties that these products are free from patent, copyright or mask work right infringement unless otherwise specified. Applications that are described in this user guide are for illustration purposes only. Kontron makes no representation or warranty that such application will be suitable for the specified use without further testing or modification. Kontron expressly informs the user that this user guide only contains a general description of processes and instructions which may not be applicable in every individual case. In cases of doubt, please contact Kontron.

This user guide is protected by copyright. All rights are reserved by Kontron. No part of this document may be reproduced, transmitted, transcribed, stored in a retrieval system, or translated into any language or computer language, in any form or by any means (electronic, mechanical, photocopying, recording, or otherwise), without the express written permission of Kontron. Kontron points out that the information contained in this user guide is constantly being updated in line with the technical alterations and improvements made by Kontron to the products and thus this user guide only reflects the technical status of the products by Kontron at the time of publishing.

Brand and product names are trademarks or registered trademarks of their respective owners.

©2020 by Kontron AG

Kontron AG

Lise-Meitner-Str. 3-5
86156 Augsburg
Germany
www.kontron.com

High Risk Applications Hazard Notice

THIS DEVICE AND ASSOCIATED SOFTWARE ARE NOT DESIGNED, MANUFACTURED OR INTENDED FOR USE OR RESALE FOR THE OPERATION OF NUCLEAR FACILITIES, THE NAVIGATION, CONTROL OR COMMUNICATION SYSTEMS FOR AIRCRAFT OR OTHER TRANSPORTATION, AIR TRAFFIC CONTROL, LIFE SUPPORT OR LIFE SUSTAINING APPLICATIONS, WEAPONS SYSTEMS, OR ANY OTHER APPLICATION IN A HAZARDOUS ENVIRONMENT, OR REQUIRING FAIL-SAFE PERFORMANCE, OR IN WHICH THE FAILURE OF PRODUCTS COULD LEAD DIRECTLY TO DEATH, PERSONAL INJURY, OR SEVERE PHYSICAL OR ENVIRONMENTAL DAMAGE (COLLECTIVELY, "HIGH RISK APPLICATIONS").

You understand and agree that your use of Kontron devices as a component in High Risk Applications is entirely at your risk. To minimize the risks associated with your products and applications, you should provide adequate design and operating safeguards. You are solely responsible for compliance with all legal, regulatory, safety, and security related requirements concerning your products. You are responsible to ensure that your systems (and any Kontron hardware or software components incorporated in your systems) meet all applicable requirements. Unless otherwise stated in the product documentation, the Kontron device is not provided with error-tolerance capabilities and cannot therefore be deemed as being engineered, manufactured or setup to be compliant for implementation or for resale as device in High Risk Applications. All application and safety related information in this document (including application descriptions, suggested safety measures, suggested Kontron products, and other materials) is provided for reference only.

Revision History

Revision	Brief Description of Changes	Date of Issue
1.0	Initial Issue	2018-Dec-25
1.1	Update CPU description	2020-Jul-17

Terms and Conditions

Kontron warrants products in accordance with defined regional warranty periods. For more information about warranty compliance and conformity, and the warranty period in your region, visit <http://www.kontron.com/terms-and-conditions>.

Kontron sells products worldwide and declares regional General Terms & Conditions of Sale, and Purchase Order Terms & Conditions. Visit <http://www.kontron.com/terms-and-conditions>.

For contact information, refer to the corporate offices contact information on the last page of this user guide or visit our website [CONTACT US](#).

Customer Support

Find Kontron contacts by visiting: <http://www.kontron.com/support>.

Customer Service

As a trusted technology innovator and global solutions provider, Kontron extends its embedded market strengths into a services portfolio allowing companies to break the barriers of traditional product lifecycles. Proven product expertise coupled with collaborative and highly-experienced support enables Kontron to provide exceptional peace of mind to build and maintain successful products.

For more details on Kontron's service offerings such as: enhanced repair services, extended warranty, Kontron training academy, and more visit <http://www.kontron.com/support-and-services/services>.

Customer Comments

If you have any difficulties using this user guide, discover an error, or just want to provide some feedback, contact [Kontron support](#). Detail any errors you find. We will correct the errors or problems as soon as possible and post the revised user guide on our website.

Symbols

The following symbols may be used in this user guide

⚠ DANGER

DANGER indicates a hazardous situation which, if not avoided, will result in death or serious injury.

⚠ WARNING

WARNING indicates a hazardous situation which, if not avoided, could result in death or serious injury.

NOTICE

NOTICE indicates a property damage message.

⚠ CAUTION

CAUTION indicates a hazardous situation which, if not avoided, may result in minor or moderate injury.



Electric Shock!

This symbol and title warn of hazards due to electrical shocks (> 60 V) when touching products or parts of products. Failure to observe the precautions indicated and/or prescribed by the law may endanger your life/health and/or result in damage to your material.



ESD Sensitive Device!

This symbol and title inform that the electronic boards and their components are sensitive to static electricity. Care must therefore be taken during all handling operations and inspections of this product in order to ensure product integrity at all times.



HOT Surface!

Do NOT touch! Allow to cool before servicing.



Laser!

This symbol inform of the risk of exposure to laser beam and light emitting devices (LEDs) from an electrical device. Eye protection per manufacturer notice shall review before servicing.



This symbol indicates general information about the product and the user guide.

This symbol also indicates detail information about the specific product configuration.



This symbol precedes helpful hints and tips for daily use.

For Your Safety

Your new Kontron product was developed and tested carefully to provide all features necessary to ensure its compliance with electrical safety requirements. It was also designed for a long fault-free life. However, the life expectancy of your product can be drastically reduced by improper treatment during unpacking and installation. Therefore, in the interest of your own safety and of the correct operation of your new Kontron product, you are requested to conform with the following guidelines.

High Voltage Safety Instructions

As a precaution and in case of danger, the power connector must be easily accessible. The power connector is the product's main disconnect device.

CAUTION

Warning

All operations on this product must be carried out by sufficiently skilled personnel only.

CAUTION



Electric Shock!

Before installing a non hot-swappable Kontron product into a system always ensure that your mains power is switched off. This also applies to the installation of piggybacks. Serious electrical shock hazards can exist during all installation, repair, and maintenance operations on this product. Therefore, always unplug the power cable and any other cables which provide external voltages before performing any work on this product.

Earth ground connection to vehicle's chassis or a central grounding point shall remain connected. The earth ground cable shall be the last cable to be disconnected or the first cable to be connected when performing installation or removal procedures on this product.

Special Handling and Unpacking Instruction

NOTICE



ESD Sensitive Device!

Electronic boards and their components are sensitive to static electricity. Therefore, care must be taken during all handling operations and inspections of this product, in order to ensure product integrity at all times.

Do not handle this product out of its protective enclosure while it is not used for operational purposes unless it is otherwise protected.

Whenever possible, unpack or pack this product only at EOS/ESD safe work stations. Where a safe work station is not guaranteed, it is important for the user to be electrically discharged before touching the product with his/her hands or tools. This is most easily done by touching a metal part of your system housing.

It is particularly important to observe standard anti-static precautions when changing piggybacks, ROM devices, jumper settings etc. If the product contains batteries for RTC or memory backup, ensure that the product is not placed on conductive surfaces, including anti-static plastics or sponges. They can cause short circuits and damage the batteries or conductive circuits on the product.

Lithium Battery Precautions

If your product is equipped with a lithium battery, take the following precautions when replacing the battery.

⚠ CAUTION

Danger of explosion if the battery is replaced incorrectly.

- ▶ Replace only with same or equivalent battery type recommended by the manufacturer.
- ▶ Dispose of used batteries according to the manufacturer's instructions.

General Instructions on Usage

In order to maintain Kontron's product warranty, this product must not be altered or modified in any way. Changes or modifications to the product, that are not explicitly approved by Kontron and described in this user guide or received from Kontron Support as a special handling instruction, will void your warranty.

This product should only be installed in or connected to systems that fulfill all necessary technical and specific environmental requirements. This also applies to the operational temperature range of the specific board version that must not be exceeded. If batteries are present, their temperature restrictions must be taken into account.

In performing all necessary installation and application operations, only follow the instructions supplied by the present user guide.

Keep all the original packaging material for future storage or warranty shipments. If it is necessary to store or ship the product then re-pack it in the same manner as it was delivered.

Special care is necessary when handling or unpacking the product. See Special Handling and Unpacking Instruction.

Quality and Environmental Management

Kontron aims to deliver reliable high-end products designed and built for quality, and aims to complying with environmental laws, regulations, and other environmentally oriented requirements. For more information regarding Kontron's quality and environmental responsibilities, visit <http://www.kontron.com/about-kontron/corporate-responsibility/quality-management>.

Disposal and Recycling

Kontron's products are manufactured to satisfy environmental protection requirements where possible. Many of the components used are capable of being recycled. Final disposal of this product after its service life must be accomplished in accordance with applicable country, state, or local laws or regulations.

WEEE Compliance

The Waste Electrical and Electronic Equipment (WEEE) Directive aims to:

- ▶ Reduce waste arising from electrical and electronic equipment (EEE)
- ▶ Make producers of EEE responsible for the environmental impact of their products, especially when the product become waste
- ▶ Encourage separate collection and subsequent treatment, reuse, recovery, recycling and sound environmental disposal of EEE
- ▶ Improve the environmental performance of all those involved during the lifecycle of EEE



Environmental protection is a high priority with Kontron.

Kontron follows the WEEE directive

You are encouraged to return our products for proper disposal.

Table of Contents

Symbols.....	6
For Your Safety	7
High Voltage Safety Instructions	7
Special Handling and Unpacking Instruction	7
Lithium Battery Precautions.....	8
General Instructions on Usage	8
Quality and Environmental Management	8
Disposal and Recycling.....	8
WEEE Compliance.....	8
Table of Contents	9
List of Tables	11
List of Figures	11
1/ General Safety Instructions for IT Equipment	12
1.1. Electrostatic Discharge (ESD).....	14
1.1.1. Grounding Methods	14
1.2. Lithium Battery Replacement	14
2/ Electromagnetic Compatibility	16
2.1. Electromagnetic Compatibility (EU).....	16
2.2. FCC Statement (USA).....	16
2.3. EMC Compliance (Canada)	16
3/ Shipment and Unpacking	17
3.1. Unpacking	17
3.2. Scope of Delivery	17
3.2.1. Standard	17
3.2.2. Optional Parts	17
4/ System Overview	18
4.1. System Expansion Capabilities	19
4.1.1. System Expansion via SATA Interface.....	19
4.1.2. System Expansion via mPCIe Card Interface.....	19
4.2. Front I/O Panel.....	20
4.2.1. Power Button with LED.....	20
4.2.2. Storage LED	21
4.2.3. Wireless LED.....	21
4.2.4. Line-Out / Mic-In	21
4.2.5. USB 3.0.....	21
4.2.6. IR Receiver.....	21
4.3. Rear I/O Panel	22
4.3.1. DC-In (DC Jack).....	22
4.3.2. DP	22
4.3.3. HDMI.....	22
4.3.4. GbE.....	22
4.3.5. RS232/422/485	23
4.3.6. Reset Button.....	23
4.3.7. Wafer for External Power Button.....	23
4.3.8. Antenna Port	23
4.3.9. Kensington Lock Slot	23

4.4. Internal View.....	24
4.4.1. DDR3L SO-DIMM Memory Socket.....	25
4.4.2. SATA Connector.....	25
4.4.3. mPCIe Socket.....	25
5/ Accessing Internal Components.....	27
5.1. Opening and Closing the KBox F-100/110 Series	28
5.1.1. Installing an HDD / SSD	30
5.1.2. Installing an mPCIe expansion card.....	30
6/ Thermal Considerations	31
6.1. Available Processors.....	31
6.2. Convection Cooling	31
6.3. System Clearance.....	31
6.4. Maximum Temperatures	31
6.5. Third Party Components	31
7/ Installation Instructions.....	32
7.1. System Mounting	33
7.2. DC Power Connection.....	36
8/ Starting Up.....	37
8.1. Connecting to DC Power Supply.....	37
8.2. Operating System and Hardware Component Drivers	38
9/ Maintenance and Cleaning	39
10/ Technical Specifications.....	40
10.1. Mechanical Specifications.....	41
10.1.1. Mechanical Drawing.....	41
10.2. Environmental Conditions	42
10.3. Standards and Certifications	42
11/ Standard Interfaces – Pin Assignments	43
11.1.1. DC Jack.....	43
11.1.2. Ethernet Connectors.....	43
11.1.3. USB 3.0 Port.....	43
11.1.4. HDMI Connector	44
11.1.5. DP Connector.....	45
11.1.6. RS232/422/485 Serial Port	45
11.1.7. Line-Out / Min-In Combo Jack	46
11.1.8. Wafer for External Power Switch	46
12/ uEFI BIOS	47
12.1. Starting the uEFI BIOS	47
12.2. Setup Menus.....	48
12.2.1. Main Setup Menu	48
12.2.2. Advanced Setup Menu.....	50
12.2.3. Power Setup Menu.....	59
12.2.4. Boot Setup Menu.....	61
12.2.5. Security Setup Menu	62
12.2.5.1. Remember the password	63
12.2.6. Save & Exit Setup Menu	64
Appendix A: List of Acronyms.....	65
About Kontron	66

List of Tables

Table 1: Power LED Status	20
Table 2: Technical Specifications	40
Table 3: Mechanical Specifications	41
Table 4: Environmental Conditions	42
Table 5: Standards and Certifications	42
Table 6: DC Jack (see Figure 2, pos.1)	43
Table 7: Ethernet Connector (see Figure 2, pos. 4)	43
Table 8: USB 3.0 Port (see Figure 1, pos. 5)	43
Table 9: HDMI Connector (see Figure 2, pos. 3)	44
Table 10: DP Connector (see Figure 2, pos. 2)	45
Table 11: RS232/422/485 Serial Port (see Figure 2, pos. 5)	45
Table 12: Line-Out / Mic-In Combo Jack (see Figure 1, pos. 4)	46
Table 13: Wafer for External Power Switch (see Figure 2, pos. 7)	46
Table 14: Navigation Hot Keys Available in the Legend Bar	47
Table 15: Main Setup Menu Sub-Screens and Functions	48
Table 16: List of Acronyms	65

List of Figures

Figure 1: Front I/O Panel	20
Figure 2: Rear I/O Panel	22
Figure 3: Ethernet LED Status	23
Figure 4: Internal view (top side with fan mounted on it)	24
Figure 5: Internal view (top side without fan mounted on it)	24
Figure 6: Internal view (bottom side)	25
Figure 7: Unscrewing the chassis of the KBox F-100/110 Series	28
Figure 8: Disengaging the chassis of the KBox F-100/110 Series	28
Figure 9: Unscrewing the mainboard from the chassis of the KBox F-100/110 Series	29
Figure 10: Optional VESA mounting bracket	33
Figure 11: Hole pattern of VESA mounting bracket for KBox F-100/110 Series	33
Figure 12: Securing the mounting bracket	34
Figure 13: Fixing slots of the KBox F-100/110 Series	34
Figure 14: Securing the KBox F-100/110 Series onto the mounting bracket	34
Figure 15: Mechanical Drawing	41
Figure 16: BIOS Main Menu Screen System Data and Time	49
Figure 17: BIOS Advanced Menu	51
Figure 18: BIOS Advanced Menu - Display Configuration	52
Figure 19: BIOS Advanced Menu - Super IO Configuration	53
Figure 20: BIOS Advanced Menu - Super IO Configuration - Serial Port 1 Configuration	53
Figure 21: BIOS Advanced Menu - CPU Chipset Configuration	55
Figure 22: BIOS Advanced Menu - SATA Configuration	56
Figure 23: BIOS Advanced Menu - USB Configuration	57
Figure 24: BIOS Advanced Menu - H/W Monitor	58
Figure 25: BIOS Advanced Menu - H/W Monitor - Smart FAN Configuration	58
Figure 26: BIOS Power Setup Menu	59
Figure 27: BIOS Power Setup Menu - WatchDog Timer Configuration	60
Figure 28: BIOS Boot Setup Menu	61
Figure 29: BIOS Security Setup Menu	62
Figure 30: BIOS Save & Exit Setup Menu	64

1/ General Safety Instructions for IT Equipment

⚠ WARNING

Please read this chapter carefully and take careful note of the instructions, which have been compiled for your safety and to ensure to apply in accordance with intended regulations. If the following general safety instructions are not observed, it could lead to injuries to the operator and/or damage of the product; in cases of nonobservance of the instructions Kontron is exempt from accident liability, this also applies during the warranty period.

The product has been built and tested according to the basic safety requirements for low voltage (LVD) applications and has left the manufacturer in safety-related, flawless condition. To maintain this condition and also to ensure safe operation, the operator must not only observe the correct operating conditions for the product but also the following general safety instructions:

- ▶ The product must be used as specified in the product documentation, in which the instructions for safety for the product and for the operator are described. These contain guidelines for setting up, installation and assembly, maintenance, transport or storage.
- ▶ The on-site electrical installation must meet the requirements of the country's specific local regulations.
- ▶ If a power cable comes with the product, only this cable should be used. Do not use an extension cable to connect the product.
- ▶ To guarantee that sufficient air circulation is available to cool the product, please ensure that the ventilation openings are not covered or blocked. If an air filter is provided, this should be cleaned regularly. Do not place the system close to heat sources or damp places. Make sure the system is well ventilated.
- ▶ Only devices or parts which fulfill the requirements of SELV circuits (Safety Extra Low Voltage) as stipulated by IEC 60950-1 may be connected to the available interfaces.
- ▶ Before opening the device, make sure that the device is disconnected from the mains.
- ▶ Switching off the device by its power button does not disconnect it from the mains. Complete disconnection is only possible if the power cable is removed from the wall plug or from the device. Ensure that there is free and easy access to enable disconnection.
- ▶ The device may only be opened for the insertion or removal of add-on cards (depending on the configuration of the system). This may only be carried out by qualified operators.
- ▶ If extensions are being carried out, the following must be observed:
 - ▶ All effective legal regulations and all technical data are adhered to.
 - ▶ The power consumption of any add-on card does not exceed the specified limitations.
 - ▶ The current consumption of the system does not exceed the value stated on the product label.
- ▶ Only original accessories that have been approved by Kontron can be used.
- ▶ Please note: safe operation is no longer possible when any of the following applies:
 - ▶ The device has visible damages.
 - ▶ The device is no longer functioning.

In this case the device must be switched off and it must be ensured that the device can no longer be operated.

Additional safety instructions for DC power supply circuits

- ▶ To guarantee safe operation of devices with DC power supply voltages larger than 60 volts DC or a power consumption larger than 240 VA, please observe that:
 - ▶ the device is set up, installed and operated in a room or enclosure marked with "RESTRICTED ACCESS", if there are no safety messages on product as safety signs and labels on the device itself.
 - ▶ no cables or parts without insulation in electrical circuits with dangerous voltage or power should be touched directly or indirectly
 - ▶ a reliable protective earthing connection is provided
 - ▶ a suitable, easily accessible disconnecting device is used in the application (e.g. overcurrent protective device), if the device itself is not disconnectable
 - ▶ a disconnect device, if provided in or as part of the equipment, shall disconnect both poles simultaneously
 - ▶ interconnecting power circuits of different devices cause no electrical hazards
- ▶ A sufficient dimensioning of the power cable wires must be selected – according to the maximum electrical specifications on the product label – as stipulated by EN60950-1 or VDE0100 or EN60204 or UL508 regulations.
- ▶ The devices do not generally fulfill the requirements for "centralized DC power systems" (UL 60950-1, Annex NAB; D2) and therefore may not be connected to such devices!

1.1. Electrostatic Discharge (ESD)



A sudden discharge of electrostatic electricity can destroy static-sensitive devices or micro-circuitry.

Therefore proper packaging and grounding techniques are necessary precautions to prevent damage. Always take the following precautions:

1. Transport boards in ESD-safe containers such as boxes or bags.
2. Keep electrostatic sensitive parts in their containers until they arrive at the ESD-safe workplace.
3. Always be properly grounded when touching a sensitive board, component, or assembly.
4. Store electrostatic-sensitive boards in protective packaging or on antistatic mats.

1.1.1. Grounding Methods

By adhering to the guidelines below, electrostatic damage to the device can be avoided:

1. Cover workstations with approved antistatic material. Always wear a wrist strap connected to workplace. Always use properly grounded tools and equipment.
2. Use antistatic mats, heel straps, or air ionizers for more protection.
3. Always handle electrostatically sensitive components by their edge or by their casing.
4. Avoid contact with pins, leads, or circuitry.
5. Turn off power and input signals before inserting and removing connectors or connecting test equipment.
6. Keep work area free of non-conductive materials such as ordinary plastic assembly aids and Styrofoam.
7. Use only field service tools which are conductive, such as cutters, screwdrivers, and vacuum cleaners.
8. Always place drives and boards PCB-assembly-side down on the foam.

1.2. Lithium Battery Replacement

If replacing the lithium battery, follow the replacement precautions stated below.

⚠ WARNING

Do not ingest battery, Chemical Burn Hazard

This product contains a coin / button cell battery. If the coin / button cell battery is swallowed, it can cause severe internal burns in just 2 hours and can lead to death.

Keep new and used batteries away from children.

If the battery compartment does not close securely, stop using the product and keep it away from children.

If you think batteries might have been swallowed or placed inside any part of the body, seek immediate medical attention.

Replacement of a battery with an incorrect type, that can result in an explosion.

Replace only with the same or equivalent type recommended by the manufacturer. The lithium battery type must be UL recognized.

Disposal of a battery into fire or a hot oven, or mechanically crushing or cutting of a battery, that can result in an explosion.

Leaving a battery in an extremely high temperature surrounding environment that can result in an explosion or the leakage of flammable liquid or gas

A battery subjected to extremely low air pressure that may result in an explosion or the leakage of flammable liquid or gas



Do not dispose of lithium batteries in general trash collection. Dispose of the battery according to the local regulations dealing with the disposal of these special materials, (e.g. to the collecting points for dispose of batteries).

2/ Electromagnetic Compatibility

For detailed information refer to section 10.3 “CE Directives and Standards”.

2.1. Electromagnetic Compatibility (EU)

This product is intended only for use in industrial areas. The most recent version of the EMC guidelines (EMC Directive 2004/108/EC) apply. If the user modifies and/or adds to the equipment (e.g. installation of add-on cards) the prerequisites for the CE conformity declaration (safety requirements) may no longer apply.

▲ WARNING

This is a class A product. In domestic environment this product may cause radio interference in which case the user may be required to take adequate measures.

2.2. FCC Statement (USA)

This equipment has been tested and found to comply with the limits for a Class A digital device, pursuant to Part 15 of the FCC Rules. These limits are designed to provide reasonable protection against harmful interference when the equipment is operated in commercial environment. This equipment generates, uses, and can radiate radio frequency energy and, if not installed and used in accordance with the instruction manual, may cause harmful interference to radio communications. Operation of this equipment in residential area is likely to cause harmful interference in which case the user will be required to correct the interference at his own expense.

2.3. EMC Compliance (Canada)

The method of compliance is self-declaration to Canadian standard ICES-003:

(English): This Class A digital apparatus complies with the Canadian ICES-003.

(French): Cet appareil numérique de la class A est conforme à la norme NMB-003 du Canada.

3/ Shipment and Unpacking

Please check that your package is complete, and contains the items below (according to the ordered unit configuration). If you discover damaged or missing items, please contact your dealer.

3.1. Unpacking

Proceed as follows to unpack the unit:

1. Remove packaging.
2. Do not discard the original packaging. Keep it for future relocation.
3. Check the delivery for completeness by comparing it with your order.
4. Please keep the associated paperwork. It contains important information for handling the unit.
5. Check the contents for visible shipping damage.
6. If you notice any shipping damage or inconsistencies between the contents and your order, please contact Kontron for help and information.

3.2. Scope of Delivery

3.2.1. Standard

- ▶ 1x KBox F-100/110 Series (corresponding to the ordered system configuration)
- ▶ 1x Power Adapter
- ▶ 1x Power Cord (plug type depending on country)

3.2.2. Optional Parts

- ▶ Memory module(s) (It may be pre-installed in the system depending on ordered configuration.)
- ▶ Internal 2.5" SATA HDD / SSD (It may be pre-installed in the system depending on ordered configuration.)
- ▶ mPCIe card (It may be pre-installed in the system depending on ordered configuration.)
- ▶ Antenna(s)
- ▶ VESA mounting kit

4/ System Overview

The KBox F-100/110 Series is an embedded system enclosed within a compact aluminum chassis, offering excellent processing and graphics performance.

It can be optionally factory-equipped with an mPCIe WLAN card for two antennas. Users may choose the implementation of a 2.5" SATA HDD / SSD as storage media.

The following interfaces are available with the KBox F-100/110 Series:

Standard Front Panel:

- ▶ 4x USB 3.0
- ▶ 1x Line-Out / Mic-In
- ▶ 1x Power Button with LED
- ▶ 1x Storage LED (for 2.5" SATA HDD / SSD)
- ▶ 1x Wireless LED (for mPCIe)
- ▶ 1x IR Receiver

Standard Rear Panel:

- ▶ 1x DP
- ▶ 1x HDMI
- ▶ 1x GbE LAN
- ▶ 1x RS232/422/485
- ▶ 1x DC Jack
- ▶ 1x Reset Button
- ▶ 2x Wi-Fi Antenna Port
- ▶ 1x Wafer for External Power Button
- ▶ 1x Kensington Lock Slot

Standard Baseboard and System Expansion Capabilities:

- ▶ 2x DDR4 SO-DIMM memory socket (DIMM1 & DIMM2)
- ▶ 1x SATA Connector for 2.5" SATA HDD / SSD (SATA1)
- ▶ 1x full-sized mPCIe socket (MPCIE1)

The device is designed to be operated in:

- ▶ Vertical position: mounted on the back of the monitor or inside a control cabinet / custom enclosure / machine (with a VESA mounting kit) or
- ▶ Horizontal position: placed as a desktop unit.

NOTICE

When powering on the KBox F-100/110 Series, make sure that the ventilation slots of the chassis are not obstructed (covered) by any objects.

To provide sufficient heat dissipation by the cooling of the device, do not cover the ventilation slots of the KBox F-100/110 Series. Do not place any objects on the device. When installing the system, please keep clearance for air circulation.

4.1. System Expansion Capabilities

4.1.1. System Expansion via SATA Interface

The baseboard comes with an onboard SATA interface connector. Users can expand the KBox F-100/110 Series with a 2.5" SATA HDD / SSD drive.

4.1.2. System Expansion via mPCIe Card Interface

The baseboard comes with an onboard mPCIe interface connector. The connector is intended to be used to install an mPCIe WLAN card.



If a customer requires 3G / 4G functionality, it must be so stipulated when ordering, as an optional SIM card slot must be installed at the factory.

If an mPCIe WLAN card is installed into the KBox F-100 Series, the SIM card cage is not functional.

If an mPCIe 3G / 4G modem adapter card (and SIM card) is installed into the KBox F-100/110 Series, the WLAN function is no longer usable.

4.2. Front I/O Panel

Figure 1: Front I/O Panel

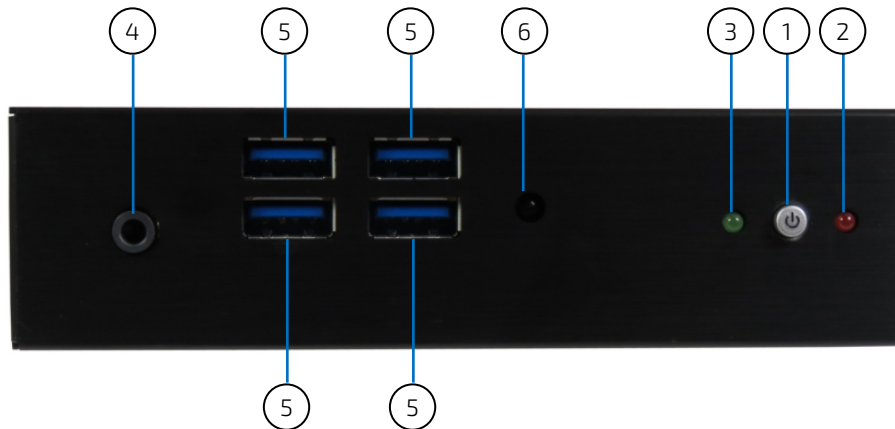

- 1 Power Button with LED (see Chapter 4.2.1)
- 2 Storage LED (see Chapter 4.2.2)
- 3 Wireless LED (see Chapter 4.2.3)
- 4 Line-Out / Mic-In (see Chapter 4.2.4)
- 5 USB 3.0 (see Chapter 4.2.5)
- 6 IR Receiver (see Chapter 4.2.6)

4.2.1. Power Button with LED

Press this button to turn the system on or off.

The power LED lights up blue if the system powered on.

Prerequisite: The system must be attached by means of the power cord to an appropriate mains (DC).

⚠ WARNING

Even when the system is turned off via the power button there is still a standby voltage on the baseboard. The unit is only completely disconnected from the DC mains, when the power is removed.

Table 1: Power LED Status

LED Status	Description
Blue LED On	S0 Power Status
Blue LED Blink	S1 Power Status
Red LED Blink	S3 Power Status
Red LED On	S4 / S5 Power Status
LED Off	EUP Power Status

4.2.2. Storage LED

The Storage LED blinks red when the data is being written into or read from the HDD / SSD which is installed in the SATA connector.

4.2.3. Wireless LED

The Wireless LED blinks green when the data is transferring over the mPCIe wireless card. The default setting is to install a Wi-Fi module. For other settings see Chapter 4.1.2.

4.2.4. Line-Out / Mic-In

The Line-Out / Mic-In combo jack is used to (1) connect an amplified speaker or headphone to output the system's audio signal; (2) connect a microphone to capture sound from a source and then input it to the system; or (3) connect a headphone with microphone.

4.2.5. USB 3.0

The KBox F-100/110 Series provides four USB 3.0 / 2.0 interfaces. These connectors allow connection of USB 3.0 or USB 2.0 compatible devices to the system.

4.2.6. IR Receiver

The IR receiver is an infrared receiving sensor allowing users to remotely control the box PC itself or the content that is displayed on connected screens.

4.3. Rear I/O Panel

Figure 2: Rear I/O Panel

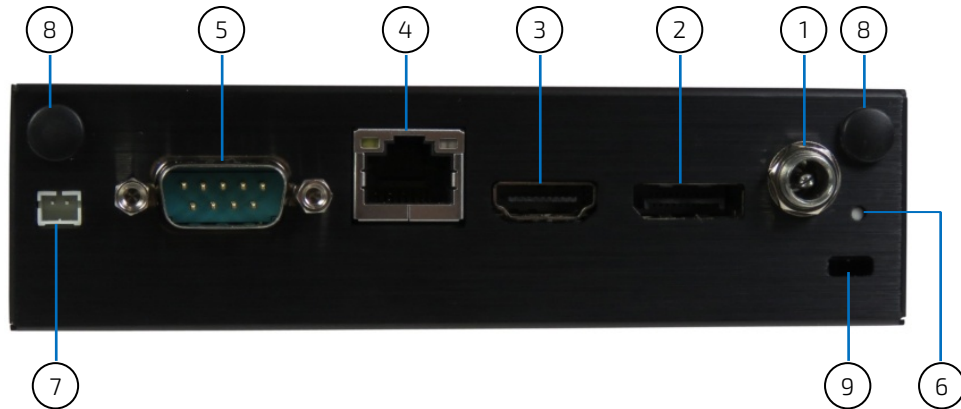

- 1 DC-In (see Chapter 4.3.1)
- 2 DP (see Chapter 4.3.2)
- 3 HDMI (see Chapter 4.3.3)
- 4 GbE (see Chapter 4.3.4)
- 5 RS232/422/485 (see Chapter 4.3.5)
- 6 Reset Button (see Chapter 4.2.6)
- 7 Wafer for External Power Button (see Chapter 4.2.7)
- 8 Antenna Port (see Chapter 4.2.8)
- 9 Kensington Lock Slot (see Chapter 4.2.9)

4.3.1. DC-In (DC Jack)

The supplied power adapter converts AC power to DC for use with this jack. Power supplied through this jack supplies power to the PC. To prevent damage to the PC, always use the supplied power adapter.

▲WARNING

Adapter's power cord shall connected to a socket-outlet with earthing connection

4.3.2. DP

An external (digital) display can be connected to this DP connector.

4.3.3. HDMI

An external (digital) display can be connected to this HDMI connector.

4.3.4. GbE

This connector is Gigabit Ethernet 10/100/1000 Mbit/s, IEEE 1588 capable interfaces. The connector is a standard 8-pin RJ45 type connector with status LEDs:

Figure 3: Ethernet LED Status

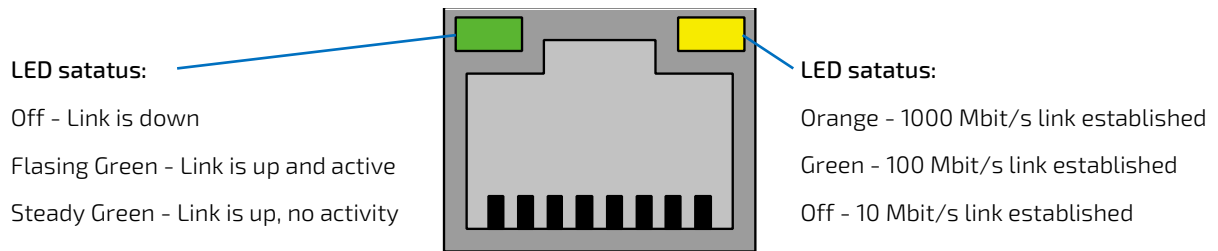

4.3.5. RS232/422/485

COM 1 is provided as a 9-pin D-SUB connector and allows the connection of a serial peripheral. It is designed to support RS232/422/485 serial communication which can be configured via BIOS setup.

4.3.6. Reset Button

The reset button allows users to clear CMOS to defaults. To initiate this function, use the tip of a pen to press the button briefly (for less than three seconds).

4.3.7. Wafer for External Power Button

This wafer allows integrators to locate an external power button / switch to easily power on and off the system in case the system is intended to be mounted / placed inside a cabinet, custom enclosure or machine.

4.3.8. Antenna Port

The KBox F-100/110 Series reserves two covered cutouts for the Reverse (RP) SMA connectors of the WLAN antennas by default setting. For other settings see Chapter 4.1.2. mPCIe wireless card with antenna(s) is an option.

4.3.9. Kensington Lock Slot

The slot is used for attaching a lock-and-cable apparatus. Locks are generally secured in place with a key or combination lock attached to a rubberized metal cable. Users can use it to attach KBox F-100/110 Series to a stationary object and protect it from theft.

Figure 6: Internal view (bottom side)

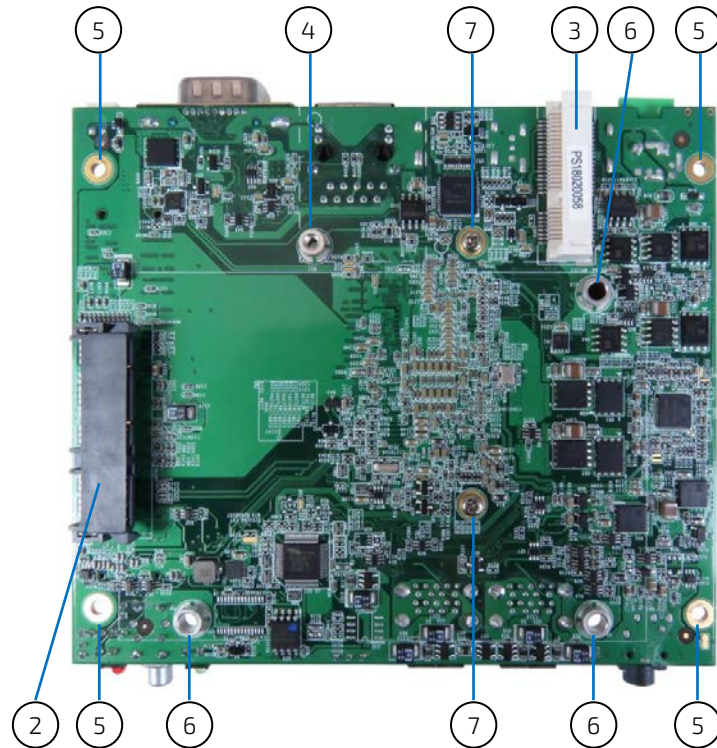

- 1 DDR4 SO-DIMM Memory Socket (DIMM1 & DIMM2, see Chapter 4.4.1)
- 2 SATA Connector (SATA1, see Chapter 4.4.2)
- 3 mPCIe Socket (MPCIE1, see Chapter 4.4.3)
- 4 mPCIe fixing bolt
- 5 Screw hole for securing the mainboard to the chassis
- 6 Screw hole for securing 2.5" HDD / SSD
- 7 Screw hole for securing CPU fan

4.4.1. DDR3L SO-DIMM Memory Socket

The KBox F-100/110 Series provides two 260-pin DDR4 SO-DIMM socket to install memory RAM.

4.4.2. SATA Connector

The KBox F-100/110 Series provided one SATA 7+ 15 pin connector to install a 2.5" SATA HDD / SSD.

4.4.3. mPCIe Socket

The KBox F-100/110 Series reserves one mPCIe socket for expansion with a full-sized WLAN card by default.

5/ Accessing Internal Components

This section contains important information that you must read before accessing the internal components. You must follow these procedures properly when installing, removing or handling any board.

It is recommended to expand your system with an additional mPCIe card before it is installed into an equipment, machine or cabinet. Please consider following instruction when you install (or remove) an expansion card.

Before installing/removing an add-on card, please pay attention to the following information:

CAUTION

Please observe the “General Safety Instructions for IT-Equipment” provided with the system (refer to the chapter 1/) and the installation instructions in this manual.

Only personnel with appropriate qualifications, trainings and authorization are permitted to install and work with the device.

The installation/removal of HDD / SSD and/or expansion cards may only be performed by a qualified person, according to the description in this manual.

Before removing the cover of the device, make sure that the device is turned off and disconnected from the power supply.

Before you upgrade the device with add-on cards, pay attention to the power specifications in chapter 10/ “Technical Specifications” and make sure that the power consumption of the add-on cards does not exceed 5 W per card.



Please follow the safety instructions for components that are sensitive to electrostatic discharge (ESD). Failure to observe this warning notice may result in damage to the device or the latter's components.



Please pay attention to the manufacturer's instructions before installing/removing an add-on card.

5.1. Opening and Closing the KBox F-100/110 Series

CAUTION

Before opening the KBox F-100/110 Series, the system must be switched off and disconnected from the main power supply. Also, disconnect all peripheral devices from the KBox F-100/110 Series. Before you begin, ensure that you have a clean, flat and ESD-safe surface to work on.

For opening and closing the KBox F-100/110 Series, please perform the following steps:

1. Close all applications. Shut down the system properly and disconnect the connection to the main power source. Disconnect all peripherals.
2. The KBox F-100/110 Series should lay on a flat, clean surface with the top side facing upwards.
3. Loosen and remove the Phillips screws (two located on left and right side of the chassis respectively), that secure two halves of the chassis together. Retain the screws for later use.

Figure 7: Unscrewing the chassis of the KBox F-100/110 Series

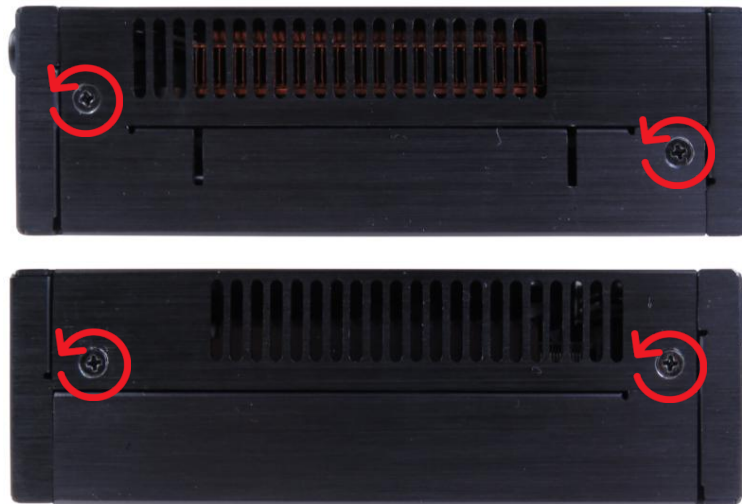

4. Slide the upper half of the chassis rearward to disengage it from the lower half.

Figure 8: Disengaging the chassis of the KBox F-100/110 Series



5. Now you have access to the internal DDR4 SO-DIMM sockets in order to remove or install RAM(s).
6. To access to the internal SATA and mPCIe slots / sockets, you have to further unscrew the mainboard from the lower half of the chassis in order to remove or install corresponding hardware components.

Figure 9: Unscrewing the mainboard from the chassis of the KBox F-100/110 Series

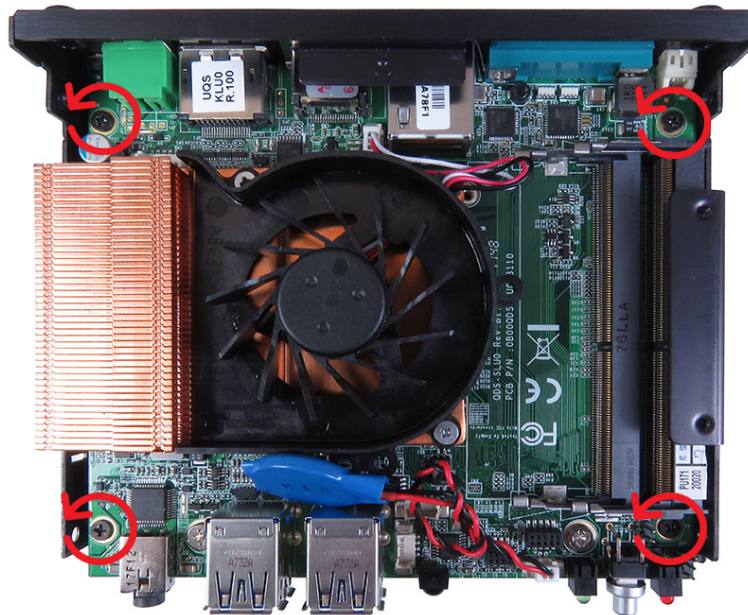

7. For closing engage carefully two halves of the chassis and screw them together with the retained screws.
8. Tighten the retained screws when the chassis is firmly in place.

NOTICE

When used as intended, the KBox F-100/110 Series is to operate only in closed condition.
 Only when the chassis is properly engaged with the screws and the rear side with WLAN antennas are properly installed and secured with the screws, it is ensured that the user does not have access to the internal parts of the KBox F-100/110 Series.

5.1.1. Installing an HDD / SSD

To install an 2.5" HDD / SSD please proceed according to the steps described:

1. Open the device as described in the subsection 5.1 "Opening and Closing the KBox F-100/110 Series" (step 1-6).
2. Locate the SATA socket (SATA1) (Figure 6, pos. 2) and the corresponding fixing bolts (Figure 6, pos. 6).
3. Align the notches on the HDD / SSD with the notches in the SATA socket (SATA1). Insert the HDD / SSD into the corresponding docket (Figure 6, pos. 2) and rotate it down with the fixing holes of the HDD / SSD over the fixing bolt.
4. Screw the HDD / SSD to the mainboard from the reverse (top) side of the mainboard.
5. In order to close the KBox F-100/110 Series, proceed step 7 & 8 described in the subsection 5.1 "Opening and Closing the KBox F-100/110 Series".

NOTICE

One of the screw holes for securing the HDD / SSD is located under the CPU fan module. You have to remove the CPU fan module first before removing or installing the HDD / SSD.

5.1.2. Installing an mPCIe expansion card

To have access the mPCIe socket please proceed according to the steps described:

1. Open the device as described in the subsection 5.1 "Opening and Closing the KBox F-100/110 Series" (step 1-6).
2. Locate the mPCIe socket (MPCIE1) (Figure 6, pos. 3) and the corresponding fixing bolt. (Figure 6, pos. 4).
3. Align the notches on the mPCIe expansion card with the notches in the mPCIe socket (MPCIE1). Insert the mPCIe expansion card into the corresponding socket (Figure 6, pos. 3) and rotate it down with the fixing hole of the card over the fixing bolt.
4. Press the mPCIe expansion card down on the side with the fixing hole and secure it with the available fastening screw (Figure 6, pos. 4).
5. In order to close the KBox F-100/110 Series, proceed step 7 & 8 described in the subsection 5.1 "Opening and Closing the KBox F-100/110 Series".

6/ Thermal Considerations

6.1. Available Processors

Please refer to the chapter 10/ "Technical Specifications".



The list of processors may be extended over the product lifetime.

6.2. Convection Cooling

The applied cooling method provides adequate cooling of the device during operation and performs a one-way thermal transfer to the airflow. There are ventilation slots located on the two sides of the KBox F-100/110 Series. They provide heat dissipation during operation.



To provide sufficient heat dissipation for the cooling of the KBox F-100/110 Series, never cover the ventilation slots of the chassis. Do not place any objects on the device.

6.3. System Clearance

To provide a maximum of airflow through and around the box, proper distances to surrounding parts must be observed.

6.4. Maximum Temperatures



The maximum system ambient temperature depends mostly on the power consumption of the processor and the chipset.

For the temperature evaluation a specialised tool from Intel® was used to set the processor to a defined workload. Depending on the power consumption one or more cores were set to 75% workload. This includes the graphics core. The tool also handles the usage of the "Turbo Mode" of certain processor types.



The processor utilization depends highly on the software used. Software using multicore feature will run on several cores whereas standard software will only utilize one core. In this case the processor will use the "Turbo Mode" to increase the clock for the core with the highest workload, as long as the temperature is within limits.

6.5. Third Party Components

When the KBox F-100/110 Series is extended and configured with third party components like mPCIe expansion card and hard drives (HDD or SSD), it has to be taken into account that the air temperature inside the system is higher than the ambient temperature. An approximately internal temperature rise is given for assistance.

7/ Installation Instructions

The KBox F-100/110 Series system is designed for operating:

- ▶ within a control cabinet/ custom enclosure / machine or onto a wall / the back of a monitor by use of a VESA mounting kit
- ▶ as desktop unit.



Expansion card installation should be performed before installing the KBox F-100/110 Series into control cabinet / custom enclosure / machine, or onto wall / monitor.

NOTICE

Whenever possible, unpack or pack this product only at EOS/ESD safe work stations. Where a safe work station is not guaranteed, it is important for the user to be electrically discharged before touching the product with his/her hands or tools. This is most easily done by touching a metal part of the system chassis.

Do not handle this product out of its protective enclosure while it is not used for operational purposes unless it is otherwise protected.

Prior any installation work, ensure that there are no live wires on the installation site.

Do not handle the device if there is any damage visible.

Do not operate the KBox F-100/110 Series with foreign objects inside the chassis.

Further do not insert any retrieval device into the device while it is connected to power.

Kontron rejects all liability for any and all damages resulting from operation of the unit with foreign objects inside the chassis.

The KBox F-100/110 Series has to be installed and operated only by trained and qualified personnel.

Only personnel with appropriate qualifications, trainings and authorization are permitted to install and work with the Kontron KBox F-100/110 Series.

This device shall only be installed in or connected to systems that fulfill all necessary technical and specific environmental requirements.

The unit must be placed such that there is sufficient space in front and rear of it for connecting the cables to the I/O interface connectors and for operating the power button.

Leave sufficient free space around the unit to prevent the device from possibly overheating!

Refer also to section 10.1.2 "Mechanical Specifications".

The KBox F-100/110 Series must be firmly attached to a clean flat and solid mounting surface. Use proper fastening materials suitable for the mounting surface. Ensure that the mounting surface type and the used mounting solution safely support the load of the KBox F-100/110 Series and the attached components.

Please follow the local/national regulations for grounding.

The voltage feeds must not be overloaded. Adjust the cabling and the overcurrent protection to correspond with the electrical figures indicated on the type label.

The type label is located on the bottom side of the system.

It is recommended that the last cable attached to the system should be the power cable! Refer to the section 7.2 "DC Power Connection" and chapter 8/ "Starting Up".

7.1. System Mounting

In order to adapt the KBox F-100/110 Series for mounting Kontron offers different mounting solution such as:

- ▶ KBox F-100/110 Series configuration with a VESA mounting bracket for vertical installation into a control cabinet / custom enclosure / machine or onto a wall / the back of a monitor
- ▶ KBox F-100/110 Series as desktop unit

Depending on the ordered KBox F-100/110 Series configuration, your system may be supplied with a VESA mounting bracket (Figure 10).

Figure 10: Optional VESA mounting bracket



- 1 Fixing hook
- 2 Spring cushion

The mounting bracket complies with VESA 75 and VESA 100 patterns (Figure 11). To fasten the bracket, the control cabinet / custom enclosure / machine / monitor / wall must have VESA 75 or VESA 100 screw pattern shown as Figure 11 for mounting.

Figure 11: Hole pattern of VESA mounting bracket for KBox F-100/110 Series

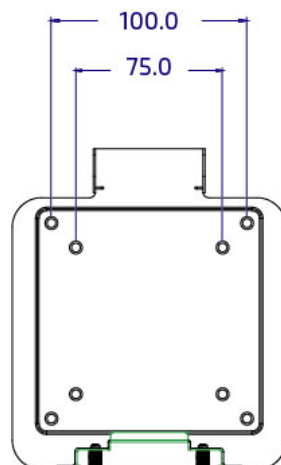

To mount the KBox F-100/110 Series please proceed according to the steps described:

1. Prepare the mounting surface with sufficient screws (four screws for VESA mount) and if necessary anchors corresponding to the mounting surface type if no VESA-compliant screw holes are available.
2. Secure the mounting bracket to the mounting surface with screws (Figure 12). The following figures take VESA mounting to a monitor as an example.

Figure 12: Securing the mounting bracket

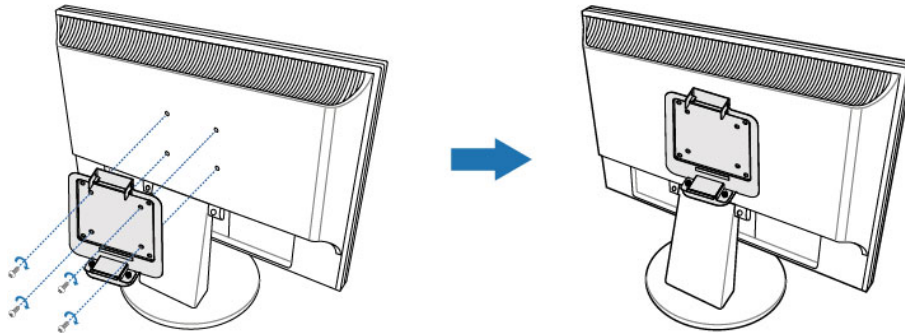

3. Align the fixing slots (Figure 13, pos. 1) on the KBox F-100/110 Series with the fixing hooks (Figure 10, pos. 1) on the mounting bracket. Engage them together (Figure 14). Push down the spring cushion (Figure 10, pos. 2) on the mounting bracket until the KBox F-100/110 Series can be completely placed on the spring cushion (Figure 14). Release the spring cushion and the KBox F-100/110 Series will be solidly secured to the mounting bracket.

Figure 13: Fixing slots of the KBox F-100/110 Series

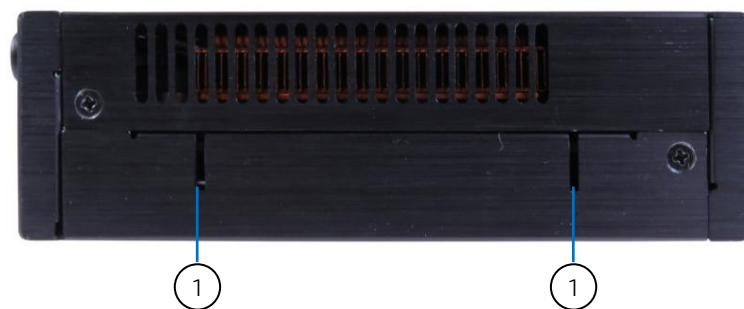

1 Fixing slot

Figure 14: Securing the KBox F-100/110 Series onto the mounting bracket

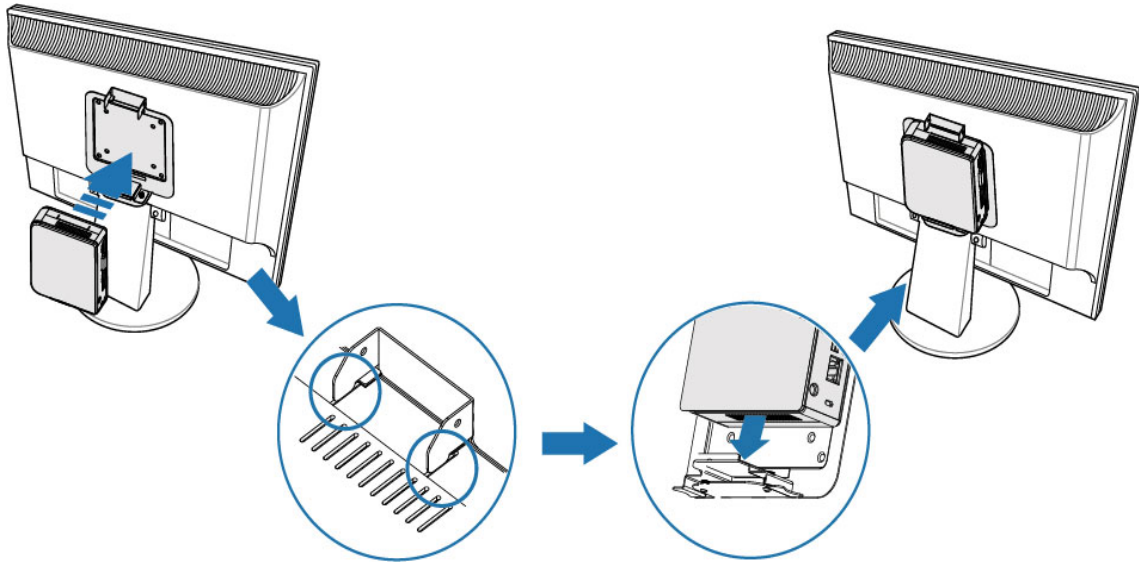

NOTICE

The ventilation slots located near the DC jack are for air outtake and must be placed upwards; those located near COM port are for air intake and must be placed downwards.



For a sufficient air circulation around the device, we recommend keep a proper clearance and not mount / operate any other devices within the clearance around the KBox F-100/110 Series.

7.2. DC Power Connection

The KBox F-100/110 Series is connected by a DC power input jack (Figure 2, pos. 1) to a DC power source.

The KBox F-100/110 Series is delivered with a power adapter to convert AC voltage into DC 12 V and a power cord to carry AC power to the power adapter.

8/ Starting Up



The KBox F-100/110 Series must be only operated with the nominal voltage of 12 V ~ 19 V DC of type SELV. For details refer to the chapter 10/ "Technical Specifications".

8.1. Connecting to DC Power Supply

The DC power input jack (Figure 2, pos. 1) is located on the rear side of the KBox F-100/110 Series. The KBox F-100/110 Series will be connected to a AC-to-DC power adapter via the supplied male DC power plug and corresponding power cable attached to the adapter.



Before using your system, become familiar with the system components and check that everything is connected properly. Following a proper cabling procedure will prevent a false power-on condition, which could result in unit operational failure.

When you install/disconnect the unit, the functional earth connection must always be made first and disconnected last.

Also, it is recommended that the last connections attached to the system should be the power wires!

NOTICE

The KBox F-100/110 Series must be connected DC main power supply complying with the SELV (Safety Extra Low Voltage) requirements of EN 60950-1 standard. It must be observed that wiring and short-circuit/overcurrent protection is performed according to the applicable standards, regulations and respect to the electrical specification of the KBox F-100/110 Series.

Even when the system is turned off via the power button (Figure 1, pos. 1) parts of the system are still energized.

The disconnecting device (fuse/circuit breaker) rating must be in accordance with the wire cross-section and the rated current of the KBox F-100/110 Series.



The cables must have some form of support so as to minimize the strain on the unit's connectors.

To connect the KBox F-100/110 Series to a corresponding DC power supply, please perform the following steps:

1. Connect the power adapter cable to the DC jack (DC IN, Figure 2, pos. 1) of the KBox F-100/110 Series.
2. Connect the power cable to the power adapter.
3. Connect the power cable to a power outlet.
4. Press the power button (Figure 1, pos. 1) on the front panel to turn on the system.

8.2. Operating System and Hardware Component Drivers

Your system can be supplied optionally with a pre-installed operating system.

If you have ordered your KBox F-100/110 Series with a pre-installed operating system, all drivers are installed in accordance with the system configuration ordered (optional hardware components). Your system is fully operational when you switch it on for the first time.

If you have ordered The KBox F-100/110 Series without a pre-installed operating system, you will need to install the operating system and the appropriate drivers for the system configuration you have ordered (optional hardware components) yourself.



You can download the relevant drivers for the installed hardware from our web site at www.kontron.com by selecting the product.

Pay attention to the manufacturer specifications of the operating system and the integrated hardware components.

9/ Maintenance and Cleaning

Equipment from Kontron requires only minimum servicing and maintenance for proper operation.

- ▶ For light soiling, clean the KBox F-100/110 Series with a dry cloth. Carefully remove dust from the surface of the cooling fins of the chassis using a clean, soft brush.
- ▶ Stubborn dirt should be removed using a mild detergent and a soft cloth.



Do not use steel wool, metallic threads or solvents like abrasives, alcohol, acetone or benzene for cleaning the KBox F-100/110 Series.

10/ Technical Specifications

Table 2: Technical Specifications

System	
Processor	▶ 7th / 6th Generation Intel® Core™ / Celeron® U-Series Processors (15 W TDP)
Memory	▶ 2x DDR4 SO-DIMM memory socket
Video	
Display Interface	▶ 1x HDMI (on rear) ▶ 1x DP (on rear)
Multiple Display	▶ Dual
Audio	
Audio Codec	▶ Realtek ALC662
Audio Interface	▶ 1x Line-out / Mic-In (on front)
Network Connection	
Ethernet	▶ 1x GbE LAN (RJ45 on rear, Intel® I219)
Peripheral Connection	
USB	▶ 4x USB 3.0 (Type A on front)
Serial Port	▶ 1x RS232/422/485 (DB9 on rear)
Storage & Expansion	
Storage & Expansion	▶ 1x 2.5" SATA HDD / SSD ▶ 1x mPCIe (full size) ▶ 1x SIM Card Cage (by cable, optional)
Power	
Input Voltage & Connector	▶ DC 12 V ~ 19 V (Lockable DC Jack on rear) ▶ DC 24 V (2-pin Phoenix Connector on rear)
Firmware	
BIOS	▶ AMI uEFI BIOS w/ 128 Mb SPI Flash
Watchdog	▶ Programmable WDT to generate system reset event
H/W Monitor	▶ Input & Core Voltages, CPU & System Temperatures
Real Time Clock	▶ Processor integrated RTC
TPM	▶ Optional (Infineon SLB 9665 TPM 2.0)
System Control & Monitoring	
Button, Switch & Indicator	▶ 1x Power Button w/ LED (on front) ▶ 1x Wafer for External Power Button (on rear) ▶ 1x Reset Button (on rear) ▶ 1x IR Receiver (on front) ▶ 1x Storage LED (on front) ▶ 1x Wireless LED (on front)
Cooling	
Cooling Method	▶ 1x CPU Smart Fan

Software	
OS Support	Windows 10, Linux

10.1. Mechanical Specifications

Table 3: Mechanical Specifications

Construction	Aluminum Chassis
Dimensions (W x D x H)	130 mm x 111 mm x 35 mm / 5.12" x 4.37" x 1.38"
Weight	400 g / 0.97 lb
Mounting	VESA Mount

10.1.1. Mechanical Drawing

Figure 15: Mechanical Drawing

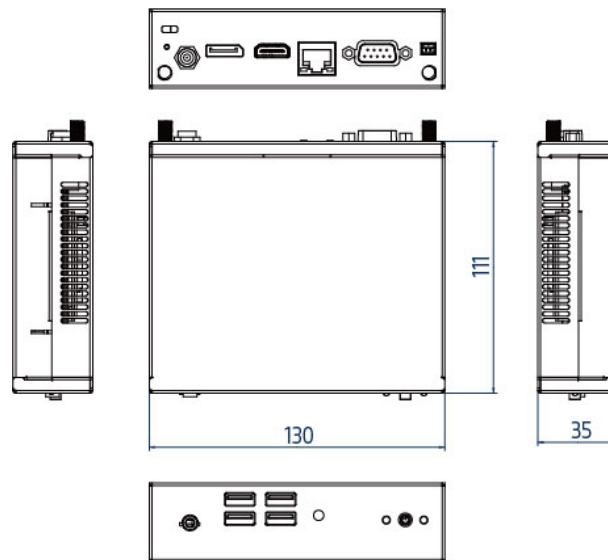

(unit: mm)

10.2. Environmental Conditions

Table 4: Environmental Conditions

Operating Temperature	0 °C ~ 50 °C / 32 °F ~ 122 °F
Storage Temperature	-20 °C ~ 80 °C / -4 °F ~ 176 °F
Humidity	0 % ~ 90 %

10.3. Standards and Certifications

Table 5: Standards and Certifications

CE Class A	<ul style="list-style-type: none"> ▶ EN 55032: 2015 + AC: 2016, CISPR 32: 2015 + COR1: 2016: Class A, AS/NZS CISPR 32: 2015: Class A ▶ EN 61000-3-2: 2014 and IEC 61000-3-2: 2014 ▶ EN 61000-3-3: 2013 and IEC 61000-3-3: 2013 ▶ EN 55024: 2010 + A1: 2015 and CISPR 24: 2010 + A1: 2015 ▶ EN 61000-4-2: 2009 and IEC 61000-4-2: 2008 ▶ EN 61000-4-3: 2006 + A1: 2008 + A2: 2010 and IEC 61000-4-3: 2006 + A1: 2007 + A2: 2010 ▶ EN 61000-4-4: 2012 and IEC 61000-4-4: 2012 ▶ EN 61000-4-5: 2014 and IEC 61000-4-5: 2014 ▶ EN 61000-4-6: 2014 + AC: 2015 and IEC 61000-4-6: 2013 ▶ EN 61000-4-8: 2010 and IEC 61000-4-8: 2009 ▶ EN 61000-4-11: 2004 and IEC 61000-4-11: 2004
FCC Class A	<ul style="list-style-type: none"> ▶ FCC CFR Title 47 Part 15 Subpart B: 2016 - Section 15.107 and 15.109 ▶ ANSI C63.4-2014 ▶ ICES-003 Issue 6: 2016 ▶ Class A

11/Standard Interfaces – Pin Assignments

Low-active signals are indicated by a minus sign.

11.1.1. DC Jack

Table 6: DC Jack (see Figure 2, pos.1)

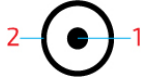
Pin	Signal Name	DC Jack (female)
1	+12-19V DC	
2	GND	

11.1.2. Ethernet Connectors

Table 7: Ethernet Connector (see Figure 2, pos. 4)

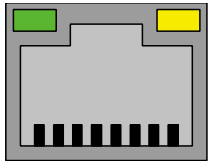
Pin	Signal Name	LAN (RJ45)
1	TX1+	 8 7 6 5 4 3 2 1
2	TX1-	
3	TX2+	
4	TX3+	
5	TX3-	
6	TX2-	
7	TX4+	
8	TX4-	

11.1.3. USB 3.0 Port

Table 8: USB 3.0 Port (see Figure 1, pos. 5)

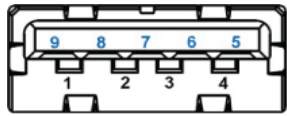
USB 2.0 Contact Pins		USB 3.0 Contact Pins		9-pin USB Connector Type A Version 3.0 / 2.0
Pin	Signal Name	Pin	Signal Name	
1	+USBVCC	5	USB_RX-	
2	USB_D-	6	USB_RX+	
3	USB_D+	7	GND	
4	GND	8	USB_TX-	
		9	USB_TX+	

11.1.4. HDMI Connector

Table 9: HDMI Connector (see Figure 2, pos. 3)

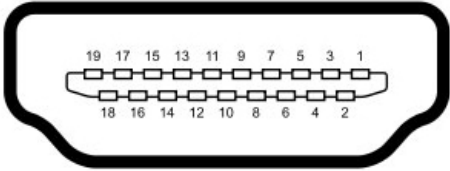
Pin	Signal Name	HDMI Connector Type A Version 1.4
1	TMDS Data2+	
2	Ground	
3	TMDS Data2-	
4	TMDS Data1+	
5	Ground	
6	TMDS Data1-	
7	TMDS Data0+	
8	Ground	
9	TMDS Data0-	
10	TMDS Clock+	
11	Ground	
12	TMDS Clock-	
13	Reserved	
14	Reserved	
15	DDC_CLK	
16	DDC_DATA	
17	Ground	
18	+5 V Power	
19	Hot Plug Detect	

11.1.5. DP Connector

Table 10: DP Connector (see Figure 2, pos. 2)

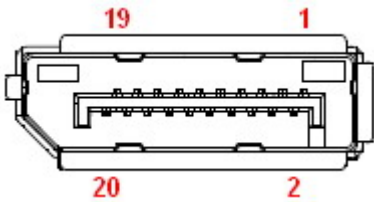
Pin	Signal Name	20-pin DP Connector
1	TX0+	
2	GND	
3	TX0-	
4	TX1+	
5	GND	
6	TX1-	
7	TX2+	
8	GND	
9	TX2-	
10	TX3+	
11	GND	
12	TX3-	
13	GND	
14	GND	
15	AUX+	
16	GND	
17	AUX-	
18	HPD	
19	GND	
20	PWR	

11.1.6. RS232/422/485 Serial Port

Table 11: RS232/422/485 Serial Port (see Figure 2, pos. 5)

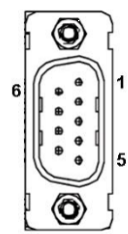
Pin	RS232	RS422	RS485 Half Duplex	RS485 Full Duplex	COM (9-pin D-SUB Male Connector)
1	DCD	TX-	DATA-	TX-	
2	RXD	RX+	N/A	RX+	
3	TXD	TX+	DATA+	TX+	
4	DTR	RX-	N/A	RX-	
5	GND	GND	GND	GND	
6	DSR	N/A	N/A	N/A	
7	RTS	N/A	N/A	N/A	
8	CTS	N/A	N/A	N/A	
9	RI	N/A	N/A	N/A	

11.1.7. Line-Out / Min-In Combo Jack

Table 12: Line-Out / Mic-In Combo Jack (see Figure 1, pos. 4)

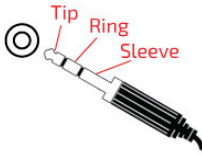
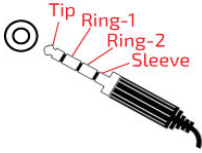
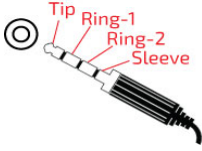
Pin	Signal Name	Audio Connector & Corresponding Audio Jack Plug
TRS Type Headphone Jack Plug (support audio / headphone output only)		
Tip	Line-Out_L	
Ring	Line-Out_R	
Sleeve	GND	
Standard TRRS Type Headphone / Microphone Combo Jack Plug (support audio / headphone output and microphone input)		
Tip	Line-Out_L	
Ring-1	Line-Out_R	
Ring-2	GND	
Sleeve	Mic-In	
OMTP TRRS Type Headphone / Microphone Combo Jack Plug (support audio / headphone output only)		
Tip	Line-Out_L	
Ring-1	Line-Out_R	
Ring-2	Mic-in	
Sleeve	GND	



When plugging a microphone or combined headset into the audio combo jack, make sure the required connector type is correct, otherwise, the microphone will not work.

11.1.8. Wafer for External Power Switch

Table 13: Wafer for External Power Switch (see Figure 2, pos. 7)

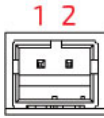
Pin	Signal Name	Wafer for External Power Switch
1	PWR_SW+	
2	PWR_SW-	

12/ uEFI BIOS

12.1. Starting the uEFI BIOS

The KBox F-100/110 Series is provided with a Kontron-customized, pre-installed and configured version of AMI Aptio® V uEFI BIOS. AMI BIOS firmware is based on the Unified Extensible Firmware Interface (uEFI) specification and the Intel® Platform Innovation Framework for EFI. This uEFI BIOS provides a variety of new and enhanced functions specifically tailored to the hardware features of the KBox F-100/110 Series.



The BIOS version covered in this document might not be the latest version. The latest version might have certain differences to the BIOS options and features described in this chapter.

The uEFI BIOS comes with a setup program that provides quick and easy access to the individual function settings for control or modification of the uEFI BIOS configuration. The setup program allows the accessing of various menus that provide functions or access to sub-menus with more specific functions of their own.

To start the uEFI BIOS setup program, follow the steps below:

1. Power on the board.
2. Wait until the first characters appear on the screen (POST messages or splash screen).
3. Press the key.
4. If the uEFI BIOS is password-protected, a request for password will appear. Enter either the User Password or the Supervisor Password (see Security menu), press <RETURN>, and proceed with step 5.
5. A setup menu will appear.

The KBox F-100/110 Series uEFI BIOS setup program uses a hot key-based navigation system. A hot key legend bar is located on the bottom of the setup screens.

The following table provides information concerning the usage of these hot keys.

Table 14: Navigation Hot Keys Available in the Legend Bar

Hotkeys	Description
<F1>	The <F1> key invokes the General Help window.
<->	The <Minus> key selects the next lower value within a field.
<+>	The <Plus> key selects the next higher value within a field.
<F2>	The <F2> key loads the previous values.
<F3>	The <F3> key loads the standard default values.
<F4>	The <F4> key saves the current settings and exit the uEFI BIOS setup.
<→> or <←>	The <Left/Right> arrows selects major setup menus on the menu bar. For example: Main, Advanced, Security, etc.
<↑> or <↓>	The <Up/Down> arrows selects fields in the current menu. For example: A setup function or a sub-screen.
<ESC>	The <ESC> key exits a major setup menu and enter the Exit setup menu. Pressing the <ESC> key in a sub-menu displays the next higher menu level.
<RERURN>	The <RETURN> key executes a command or select a submenu.

12.2. Setup Menus

The Setup utility features shows six menus in the selection bar at the top of the screen:

- ▶ Main
- ▶ Advanced
- ▶ Power
- ▶ Boot
- ▶ Security
- ▶ Save & Exit

The Setup menus are selected via the left and right arrow keys. The currently active menu and the currently active uEFI BIOS Setup item are highlighted in white. Each Setup menu provides two main frames. The left frame displays all available functions. Functions that can be configured are displayed in blue. Functions displayed in gray provide information about the status or the operational configuration. The right frame displays an Item Specific Help window providing an explanation of the respective function.

12.2.1. Main Setup Menu

Upon entering the uEFI BIOS Setup program, the Main Setup menu is displayed. This screen lists the Main Setup menu sub-screens and provides basic system information. Additionally functions for setting the system time and date are offered.

Table 15: Main Setup Menu Sub-Screens and Functions

Function	Description
BIOS Information	Read only field. Displays information about the system BIOS
Memory Information	Read only field. Displays information about total memory
ME Information	Read only field. Displays information about Intel Management Engine (ME) version
Firmware Information	Code version and firmware information
System Date	Set System Date
System Time	Set System Time

Figure 16: BIOS Main Menu Screen System Data and Time

BIOS SETUP UTILITY					
Main	Advanced	Power	Boot	Security	Save & Exit
Product Information					
Product Name		KBox F-100			
BIOS Version		R0.02 (x64)			
BIOS Build Date		12/13/2016			
ME FW Version		11.6.10.1196			
CPU Information					
Intel® Core™ i5-6200U CPU @ 2.30GHz					
Microcode Revision		9E			
Processor Cores		2Core(s) / 4Thread(s)		→ ←: Select Screen	
Memory Information					
Total Size		4096 MB (DDR4)		↑ ↓: Select Item	
Frequency		2133 MHz		Enter: Select	
System Date		[Fri 01/01/2016]		+/-: Change Opt.	
System Time		[00:21:45]		F1: General Help	
Access Level		Administrator		F2: Previous Values	
				F3: Optimized Defaults	
				F4: Save & Exit	
				ESC: Exit	
Version 2.18.1263. Copyright (C) 2016, American Megatrends, Inc.					

Feature	Option	Description
System Date	[dd/mm/yyyy]	Set the Date. Use Tab to switch between Data elements.
System Time	[hh:mm:ss]	Set the Time. Use Tab to switch between Time elements.

12.2.2. Advanced Setup Menu

The Advanced setup menu provides sub-screens and functions for advanced configurations. The following sub-screen functions are included in the menu:

- ▶ LAN & Audio Configuration
- ▶ Display Configuration
- ▶ Super IO Configuration
- ▶ CPU Chipset Configuration
- ▶ SATA Configuration
- ▶ USB Configuration
- ▶ H/W Monitor

NOTICE

Setting items on this screen to incorrect values may cause the system to malfunction.

Figure 17: BIOS Advanced Menu

BIOS SETUP UTILITY					
Main	Advanced	Power	Boot	Security	Save & Exit
Onboard LAN1 Controller		[Enabled]			
Onboard LAN1 Boot		[Disabled]			
Audio Controller		[Enabled]			
> Display Configuration					
> Super IO Configuration					
> CPU Chipset Configuration					
> SATA Configuration					
> USB Configuration					
> H/W Monitor					
				→ ←: Select Screen	
				↑ ↓: Select Item	
				Enter: Select	
				+/-: Change Opt.	
				F1: General Help	
				F2: Previous Values	
				F3: Optimized Defaults	
				F4: Save & Exit	
				ESC: Exit	
Version 2.18.1263. Copyright (C) 2016, American Megatrends, Inc.					

Feature	Option	Description
Onboard LAN1 Controller	[Disabled], [Enabled]	Select whether to enable or disable Onboard LAN1 Controller.
Onboard LAN1 Boot	[Disabled], [Enabled]	Select whether to enable or disable load onboard PXE (Preboot Execution Environment).
Audio Controller	[Disabled], [Enabled]	Select whether to enable or disable Audio Controller.

Figure 18: BIOS Advanced Menu - Display Configuration

BIOS SETUP UTILITY					
Main	Advanced	Power	Boot	Security	Save & Exit
Display Configuration					
Primary Display		[Auto]		→ ←: Select Screen	
UWA Frame Buffer Size		[256MB]		↑ ↓: Select Item	
DVMT Pre-Allocated		[32M]		Enter: Select	
DVMT Total Gfx Mem		[256M]		+/-: Change Opt.	
Primary IGFX Boot Display		[VBIOS Default]		F1: General Help	
				F2: Previous Values	
				F3: Optimized Defaults	
				F4: Save & Exit	
				ESC: Exit	
Version 2.18.1263. Copyright (C) 2016, American Megatrends, Inc.					

Feature	Option	Description
Primary Display	[Auto], [IGD], [PCIe]	Select which graphic controller to be used as the primary display device.
UWA Frame Buffer Size	[128MB], [256MB], [512MB], [1024MB], [2048MB]	Select the Aperture Size.
DVMT Pre-Allocated	[0M], [32M], [64M], [4M], [8M], [12M], [16M], [20M], [24M], [28M], [32M/F7], [36M], [40M], [44M], [48M], [52M], [56M], [60M]	Select DVMT Pre-Allocated (Fixed) Graphics Memory size used by the Internal Graphics Device.
DVMT Total Gfx Mem	[128M], [256M], [MAX]	Select DVMT Total Graphic Memory size used by the Internal Graphics Device.
Primary IGFX Boot Display	[VBIOS Default], [DP], [HDMI]	Select the Video Device which will be activated during POST. This has no effect if external graphics present. Secondary boot display selection will appear based on your selection. DOS modes will be supported only on primary display.

Figure 19: BIOS Advanced Menu - Super IO Configuration

BIOS SETUP UTILITY					
Main	Advanced	Power	Boot	Security	Save & Exit
Super IO Configuration					
> Serial Port 1 Configuration				→ ←: Select Screen ↑ ↓: Select Item Enter: Select +/-: Change Opt. F1: General Help F2: Previous Values F3: Optimized Defaults F4: Save & Exit ESC: Exit	
Version 2.18.1263. Copyright (C) 2016, American Megatrends, Inc.					

Figure 20: BIOS Advanced Menu - Super IO Configuration - Serial Port 1 Configuration

BIOS SETUP UTILITY					
Main	Advanced	Power	Boot	Security	Save & Exit
Serial Port 1 Configuration					
Serial Port		[Enabled]		→ ←: Select Screen ↑ ↓: Select Item Enter: Select +/-: Change Opt. F1: General Help F2: Previous Values F3: Optimized Defaults F4: Save & Exit ESC: Exit	
Device Settings		IO=3F8h; IRQ=4;			
Change Setting		[Auto]			
Serial Port 1 Type		[RS232]			
RS485 Deplx Mode*		[Half Duplex]			
RS485 Auto Flow Control*		[Disabled]			
Version 2.18.1263. Copyright (C) 2016, American Megatrends, Inc.					

* These items appear only when selecting RS485 for the Serial Port 1 Type.

Feature	Option	Description
Serial Port	[Disabled], [Enabled]	Select whether to enable or disable Serial Port (COM).
Change Settings	[Auto], [IO=3F8h; IRQ=4;], [IO=3F8h; IRQ=3, 4, 5, 6, 7, 9, 10, 11, 12;], [IO=2F8h; IRQ=3, 4, 5, 6, 7, 9, 10, 11, 12;], [IO=3E8h; IRQ=3, 4, 5, 6, 7, 9, 10, 11, 12;], [IO=2E8h; IRQ=3, 4, 5, 6, 7, 9, 10, 11, 12;]	Select an optional setting for Super IO device.

Feature	Option	Description
Serial Port 1 Type	[RS232], [RS422], [RS485]	Select an appropriate type for Serial Port 1.
RS485 Duplex Mode	[Half Duplex], [Full Duplex]	Select an appropriate RS485 Duplex Mode.
RS485 Auto Flow Control	[Disabled], [Enabled]	Select whether to enable or disable RS485 Auto Flow Control.

Figure 21: BIOS Advanced Menu - CPU Chipset Configuration

BIOS SETUP UTILITY					
Main	Advanced	Power	Boot	Security	Save & Exit
CPU Chipset Configuration					
EIST		[Enabled]		→ ←: Select Screen	
Turbo Mode		[Enabled]		↑ ↓: Select Item	
Hyper-Threading		[Enabled]		Enter: Select	
VT-d		[Enabled]		+/-: Change Opt.	
Active Processor Cores		[All]		F1: General Help	
Intel (VMX) Virtualization Technology		[Disabled]		F2: Previous Values	
				F3: Optimized Defaults	
				F4: Save & Exit	
				ESC: Exit	
Version 2.18.1263. Copyright (C) 2016, American Megatrends, Inc.					

Feature	Option	Description
EIST	[Disabled], [Enabled]	Select whether to enable or disable Enhanced Intel SpeedStep Technology.
Turbo Mode	[Disabled], [Enabled]	Select whether to enable or disable turbo mode.
Hyper-Threading	[Disabled], [Enabled]	Select whether to enable or disable Hyper-threading technology. [Enabled] for Windows XP and Linux (OS optimized for Hyper-Threading Technology). [Disabled] for other OS (OS not optimized for Hyper-Threading Technology).
VT-d	[Disabled], [Enabled]	Select whether to enable or disable VT-d capability.
Active Processor Cores	[All], [1]	Select the number of cores to enable in each processor package.
Intel Virtualization Technology	[Disabled], [Enabled]	Select whether to enable or disable Intel Virtualization Technology.

Figure 22: BIOS Advanced Menu - SATA Configuration

BIOS SETUP UTILITY					
Main	Advanced	Power	Boot	Security	Save & Exit
SATA Configuration					
SATA Controller(s)		[Enabled]	→ ←: Select Screen		
SATA Mode Selection		[AHCI]	↑ ↓: Select Item		
Serial ATA Port 1		Empty	Enter: Select		
Port 1		[Enabled]	+/-: Change Opt.		
mSATA Port 1		Empty	F1: General Help		
Port 1		[Enabled]	F2: Previous Values		
			F3: Optimized Defaults		
			F4: Save & Exit		
			ESC: Exit		
Version 2.18.1263. Copyright (C) 2016, American Megatrends, Inc.					

Feature	Option	Description
SATA Controller(s)	[Enabled], [Disabled]	Select whether to enable or disable SATA Controller(s).
SATA Mode Selection	[AHCI], [Intel RST Premium]	Determine how SATA controller(s) operate.
Port 1	[Disabled], [Enabled]	Select whether to enable or disable Serial Port 1 and mSATA Port 1.

Figure 23: BIOS Advanced Menu - USB Configuration

BIOS SETUP UTILITY					
Main	Advanced	Power	Boot	Security	Save & Exit
USB Configuration					
USB Devices: 1 Keyboard				→ ←: Select Screen ↑ ↓: Select Item Enter: Select +/-: Change Opt. F1: General Help F2: Previous Values F3: Optimized Defaults F4: Save & Exit ESC: Exit	
Legacy USB Support		[Enabled]			
XHCI Hand-off		[Enabled]			
USB Mass Storage Driver Support		[Enabled]			
Version 2.18.1263. Copyright (C) 2016, American Megatrends, Inc.					

Feature	Option	Description
Legacy USB Support	[Enabled], [Disabled]	Select whether to enable or disable Legacy USB support.
XHCI Hand-off	[Enabled], [Disabled]	Select whether to enable or disable XHCI Hand-off function. This is a workaround for OSes without XHCI hand-off support. The XHCI ownership change should be claimed by XHCI driver.
USB Mass Storage Driver Support	[Disabled], [Enabled]	Select whether to enable or disable USB Mass Storage Driver Support.

Figure 24: BIOS Advanced Menu - H/W Monitor

BIOS SETUP UTILITY					
Main	Advanced	Power	Boot	Security	Save & Exit
PC Health Status					
> Smart FAN Configuration					
CPU Temperature		: +51 C			
Memory Temperature		: +41 C			
System Temperature		: +41 C			
CPU Fan Speed		: 4255 RPM		→ ←: Select Screen	
+V CORE		: +0.856 V		↑ ↓: Select Item	
+VIN		: +18.432 V		Enter: Select	
+3VCC		: +3.344 V		+/-: Change Opt.	
+3VSB		: +3.360 V		F1: General Help	
+VBAT		: +3.120 V		F2: Previous Values	
+5VA		: +5.064 V		F3: Optimized Defaults	
+3VA		: +3.296 V		F4: Save & Exit	
				ESC: Exit	
Version 2.18.1263. Copyright (C) 2016, American Megatrends, Inc.					

Figure 25: BIOS Advanced Menu - H/W Monitor - Smart FAN Configuration

BIOS SETUP UTILITY					
Main	Advanced	Power	Boot	Security	Save & Exit
Smart FAN Configuration					
CPU Smart FAN		[Enabled]		→ ←: Select Screen	
1st Boundary Temperature		25		↑ ↓: Select Item	
1st FAN Speed		60		Enter: Select	
2nd Boundary Temperature				+/-: Change Opt.	
2nd FAN Speed				F1: General Help	
3rd Boundary Temperature				F2: Previous Values	
3rd FAN Speed				F3: Optimized Defaults	
4th Boundary Temperature				F4: Save & Exit	
4th FAN Speed				ESC: Exit	
Version 2.18.1263. Copyright (C) 2016, American Megatrends, Inc.					

Feature	Option	Description
CPU Smart FAN	[Disabled], [Enabled]	Select whether to enable or disable CPU Smart FAN.

12.2.3. Power Setup Menu

The Power setup menu provides functions and a sub-screen for power configurations. The following sub-screen function is included in the menu:

- ▶ WatchDog Timer Configuration

Figure 26: BIOS Power Setup Menu

BIOS SETUP UTILITY					
Main	Advanced	Power	Boot	Security	Save & Exit
Power Configuration					
ACPI Sleep State		[S3 (Suspend to RAM)]			
Restore AC Power Loss		[Power Off]		→ ←: Select Screen	
Power Saving Mode		[Disabled]		↑ ↓: Select Item	
Resume Event Control				Enter: Select	
Resume By LAN Device		[Disabled]		+/-: Change Opt.	
Resume By PCI-E Device		[Disabled]		F1: General Help	
Resume By Ring Device		[Disabled]		F2: Previous Values	
Resume By RTC Alarm		[Disabled]		F3: Optimized Defaults	
> WatchDog Timer Configuration				F4: Save & Exit	
				ESC: Exit	
Version 2.18.1263. Copyright (C) 2016, American Megatrends, Inc.					

Feature	Option	Description
ACPI Sleep State	[S3 (Suspend to RAM)]	Select whether to enable or disable suspend function and determine an appropriate suspend mode.
Restore AC Power Loss	[Power Off], [Power On], [Last State]	Control whether the system will stay on after AC power is removed and then restored. Select [Power Off] if you want the system to remain off after power restored. Select [Power On] if you use a power strip to turn the system on.
Power Saving Mode	[Disabled], [EUP Enabled], [DeepSx Enabled]	Select whether to enable Power Saving Mode.
Resume By LAN Device	[Disabled], [Enabled]	Select whether to enable or disable Wake from LAN Device.
Resume By PCI-E Device	[Disabled], [Enabled]	Select whether to enable or disable Wake from PCI-E Device.
Resume By Ring Device	[Disabled], [Enabled]	Select whether to enable or disable Wake from Ring Device.
Resume By RTC Alarm	[Disabled], [Enabled]	Select whether to enable or disable Wake Up on Alarm, to turn on your system on a special day of the month.

Figure 27: BIOS Power Setup Menu - WatchDog Timer Configuration

BIOS SETUP UTILITY					
Main	Advanced	Power	Boot	Security	Save & Exit
WatchDog Timer Configuration					
WDT Function		[Disabled]	→ ←: Select Screen		
WDT Count Mode*		[Second]	↑ ↓: Select Item		
WDT Timer*		30	Enter: Select		
			+/-: Change Opt.		
			F1: General Help		
			F2: Previous Values		
			F3: Optimized Defaults		
			F4: Save & Exit		
			ESC: Exit		
Version 2.18.1263. Copyright (C) 2016, American Megatrends, Inc.					

* These items appear only when enabling WDT Function.

Feature	Option	Description
WDT Function	[Disabled], [Enabled]	Select whether to enable or disable WatchDog Timer function.
WDT Count Mode	[Second], [Minute]	Select WatchDog count mode: second or minute.

12.2.4. Boot Setup Menu

The boot setup menu lists the for boot device priority order, that is generated dynamically.

Figure 28: BIOS Boot Setup Menu

BIOS SETUP UTILITY					
Main	Advanced	Power	Boot	Security	Save & Exit
Boot Configuration					
Full Screen LOGO Display		[Disabled]			
Setup Prompt Timeout		1		→ ←: Select Screen	
Bootup NumLock State		[On]		↑ ↓: Select Item	
CSM Support		[Enabled]		Enter: Select	
Boot Option Filter		[Legacy Only]		+/-: Change Opt.	
Boot Option Priorities				F1: General Help	
				F2: Previous Values	
				F3: Optimized Defaults	
				F4: Save & Exit	
				ESC: Exit	
Version 2.18.1263. Copyright (C) 2016, American Megatrends, Inc.					

Feature	Option	Description
Full Screen LOGO Display	[Disabled], [Enabled]	Select whether to enable or disable to display logo screen.
Bootup NumLock State	[On], [Off]	Select the state of the NumLock feature of the keyboard after Startup. [On]: The keys on the keypad will act as numeric keys. [Off]: The keys on the keypad will act as cursor keys.
CSM Support	[Enabled], [Disabled]	Select whether to enable or disable CSM support.
Boot Option Filter	[UEFI and Legacy], [Legacy only], [UEFI only]	Control Legacy / UEFI ROMs priority.

12.2.5. Security Setup Menu

The Security setup menu provides information about the passwords and functions for specifying the security settings. The passwords are case-sensitive. The KBox F-100/110 Series provides no factory-set passwords.

NOTICE	<p>If there is already a password installed, the system asks for this first. To clear a password, simply enter nothing and acknowledge by pressing <RETURN>. To set a password, enter it twice and acknowledge by pressing <RETURN>.</p>
---------------	--

Figure 29: BIOS Security Setup Menu

BIOS SETUP UTILITY					
Main	Advanced	Power	Boot	Security	Save & Exit
Password Description If ONLY the Administrator's password is set, then this only limits access to Setup and is only asked for when entering Setup If ONLY the User's password is set, then this is a power on password and must be entered to boot or enter Setup. In Setup the User will have Administrator rights The password length must be in the following range:					
Minimum Length		3		→ ←: Select Screen ↑ ↓: Select Item Enter: Select +/-: Change Opt. F1: General Help F2: Previous Values F3: Optimized Defaults F4: Save & Exit ESC: Exit	
Maximum length		20			
Administrator Password					
User Password					
> Secure Boot					
Version 2.18.1263. Copyright (C) 2016, American Megatrends, Inc.					

Feature	Description
Administrator Password	Set administrator password
User Password	Set user password



If only the administrator's password is set, then only access to setup is limited. The password is only entered when entering setup.

If only the user's password is set, then the password is a power on password and must be entered to boot or enter setup. Within the setup menu the user has administrator rights.

Password length requirements are maximum 20 characters and minimum 3 characters.

12.2.5.1. Remember the password

It is highly recommended to keep a record of all passwords in a safe place. Forgotten passwords results in being locked out of the system.

If the system cannot be booted because the User Password or the Supervisor Password are not know, contact Kontron Support for further assistance.



HDD security passwords cannot be cleared using the above method.

12.2.6. Save & Exit Setup Menu

The exit setup menu provides functions for handling changes made to the UEFI BIOS settings and the exiting of the setup program.

Figure 30: BIOS Save & Exit Setup Menu

BIOS SETUP UTILITY					
Main	Advanced	Power	Boot	Security	Save & Exit
Save Changes and Reset					
Discard Changes and Reset					
Save Options				→ ←: Select Screen	
Save Changes				↑ ↓: Select Item	
Discard Changes				Enter: Select	
Restore Defaults				+/-: Change Opt.	
				F1: General Help	
				F2: Previous Values	
				F3: Optimized Defaults	
				F4: Save & Exit	
				ESC: Exit	
Version 2.18.1263. Copyright (C) 2016, American Megatrends, Inc.					

Feature	Description
Save Changes and Exit	Exit system setup after saving the changes. Once you are finished making your selections, choose this option from the Exit menu to ensure the values you selected are saved to the CMOS RAM. The CMOS RAM is sustained by an onboard backup battery and stays on even when the PC is turned off. When you select this option, a confirmation window appears. Select [Yes] to save changes and exit.
Discard Changes and Exit	Exit system setup without saving any changes. Select this option only if you do not want to save the changes that you made to the Setup program. If you made changes to fields other than system date, system time, and password, the BIOS asks for a confirmation before exiting.
Save Changes	Save changes done so far to any of the setup values. This option allows you to save the selections you made. After selecting this option, a confirmation appears. Select [Yes] to save any changes.
Discard Changes	Discards changes done so far to any of the setup values. This option allows you to discard the selections you made and restore the previously saved values. After selecting this option, a confirmation appears. Select [Yes] to discard any changes and load the previously saved values.
Restore Defaults	Restore Default values for all the setup values. This option allows you to load optimal default values for each of the parameters on the Setup menus, which will provide the best performance settings for your system. The F9 key can be used for this operation.



About Kontron

Kontron is a global leader in Embedded Computing Technology (ECT). As a part of technology group S&T, Kontron offers a combined portfolio of secure hardware, middleware and services for Internet of Things (IoT) and Industry 4.0 applications. With its standard products and tailor-made solutions based on highly reliable state-of-the-art embedded technologies, Kontron provides secure and innovative applications for a variety of industries. As a result, customers benefit from accelerated time-to-market, reduced total cost of ownership, product longevity and the best fully integrated applications overall. For more information, please visit: www.kontron.com / www.kontron-asia.com



PRODUCT CONTACT POINT

KONTRON ASIA INC.

4F, No. 415, Ti-Ding Blvd.,
Sec. 2, Neihu District,
Taipei, Taiwan 11493
Tel.: + 886 2 2799 2789
Fax: + 886 2 2799 7399
SalesAsia@kontron.com