

ATX-SKL-S

Doc. User Guide, Rev. 1.5

Doc. ID: [To be Determined]

This page has been intentionally left blank

 ATX-SKL-S - USER GUIDE

Disclaimer

Kontron would like to point out that the information contained in this user guide may be subject to alteration, particularly as a result of the constant upgrading of Kontron products. This document does not entail any guarantee on the part of Kontron with respect to technical processes described in the user guide or any product characteristics set out in the user guide. Kontron assumes no responsibility or liability for the use of the described product(s), conveys no license or title under any patent, copyright or mask work rights to these products and makes no representations or warranties that these products are free from patent, copyright or mask work right infringement unless otherwise specified. Applications that are described in this user guide are for illustration purposes only. Kontron makes no representation or warranty that such application will be suitable for the specified use without further testing or modification. Kontron expressly informs the user that this user guide only contains a general description of processes and instructions which may not be applicable in every individual case. In cases of doubt, please contact Kontron.

This user guide is protected by copyright. All rights are reserved by Kontron. No part of this document may be reproduced, transmitted, transcribed, stored in a retrieval system, or translated into any language or computer language, in any form or by any means (electronic, mechanical, photocopying, recording, or otherwise), without the express written permission of Kontron. Kontron points out that the information contained in this user guide is constantly being updated in line with the technical alterations and improvements made by Kontron to the products and thus this user guide only reflects the technical status of the products by Kontron at the time of publishing.

Brand and product names are trademarks or registered trademarks of their respective owners.

©2021 by Kontron S&T AG

Kontron S&T AG

Lise-Meitner-Str. 3-5
86156 Augsburg
Germany
www.kontron.com

High Risk Applications Hazard Notice

THIS DEVICE AND ASSOCIATED SOFTWARE ARE NOT DESIGNED, MANUFACTURED OR INTENDED FOR USE OR RESALE FOR THE OPERATION OF NUCLEAR FACILITIES, THE NAVIGATION, CONTROL OR COMMUNICATION SYSTEMS FOR AIRCRAFT OR OTHER TRANSPORTATION, AIR TRAFFIC CONTROL, LIFE SUPPORT OR LIFE SUSTAINING APPLICATIONS, WEAPONS SYSTEMS, OR ANY OTHER APPLICATION IN A HAZARDOUS ENVIRONMENT, OR REQUIRING FAIL-SAFE PERFORMANCE, OR IN WHICH THE FAILURE OF PRODUCTS COULD LEAD DIRECTLY TO DEATH, PERSONAL INJURY, OR SEVERE PHYSICAL OR ENVIRONMENTAL DAMAGE (COLLECTIVELY, "HIGH RISK APPLICATIONS").

You understand and agree that your use of Kontron devices as a component in High Risk Applications is entirely at your risk. To minimize the risks associated with your products and applications, you should provide adequate design and operating safeguards. You are solely responsible for compliance with all legal, regulatory, safety, and security related requirements concerning your products. You are responsible to ensure that your systems (and any Kontron hardware or software components incorporated in your systems) meet all applicable requirements. Unless otherwise stated in the product documentation, the Kontron device is not provided with error-tolerance capabilities and cannot therefore be deemed as being engineered, manufactured or setup to be compliant for implementation or for resale as device in High Risk Applications. All application and safety related information in this document (including application descriptions, suggested safety measures, suggested Kontron products, and other materials) is provided for reference only.

Revision History

Revision	Brief Description of Changes	Date of Issue
1.0	Initial Issue	2018-July-06
1.1	Update multiple display	2018-Sep-18
1.2	Update PCIe x4 signal support	2019-Mar-22
1.3	Update UDIMM amount for different models, cover and top side photo	2019-May-15
1.4	Add a LPS power supply notice in Sec. 2.1	2020-May-07
1.5	Audio codec chip replacement	2021-Mar-30

Terms and Conditions

Kontron warrants products in accordance with defined regional warranty periods. For more information about warranty compliance and conformity, and the warranty period in your region, visit <http://www.kontron.com/terms-and-conditions>.

Kontron sells products worldwide and declares regional General Terms & Conditions of Sale, and Purchase Order Terms & Conditions. Visit <http://www.kontron.com/terms-and-conditions>.

For contact information, refer to the corporate offices contact information on the last page of this user guide or visit our website [CONTACT US](#).

Customer Support

Find Kontron contacts by visiting: <http://www.kontron.com/support>.

Customer Service

As a trusted technology innovator and global solutions provider, Kontron extends its embedded market strengths into a services portfolio allowing companies to break the barriers of traditional product lifecycles. Proven product expertise coupled with collaborative and highly-experienced support enables Kontron to provide exceptional peace of mind to build and maintain successful products.

For more details on Kontron's service offerings such as: enhanced repair services, extended warranty, Kontron training academy, and more visit <http://www.kontron.com/support-and-services/services>.

Customer Comments

If you have any difficulties using this user guide, discover an error, or just want to provide some feedback, contact [Kontron support](#). Detail any errors you find. We will correct the errors or problems as soon as possible and post the revised user guide on our website.

Symbols

The following symbols may be used in this user guide

⚠ DANGER

DANGER indicates a hazardous situation which, if not avoided, will result in death or serious injury.

⚠ WARNING

WARNING indicates a hazardous situation which, if not avoided, could result in death or serious injury.

NOTICE

NOTICE indicates a property damage message.

⚠ CAUTION

CAUTION indicates a hazardous situation which, if not avoided, may result in minor or moderate injury.



Electric Shock!

This symbol and title warn of hazards due to electrical shocks (> 60 V) when touching products or parts of products. Failure to observe the precautions indicated and/or prescribed by the law may endanger your life/health and/or result in damage to your material.



ESD Sensitive Device!

This symbol and title inform that the electronic boards and their components are sensitive to static electricity. Care must therefore be taken during all handling operations and inspections of this product in order to ensure product integrity at all times.



HOT Surface!

Do NOT touch! Allow to cool before servicing.



Laser!

This symbol inform of the risk of exposure to laser beam and light emitting devices (LEDs) from an electrical device. Eye protection per manufacturer notice shall review before servicing.



This symbol indicates general information about the product and the user guide.

This symbol also indicates detail information about the specific product configuration.



This symbol precedes helpful hints and tips for daily use.

For Your Safety

Your new Kontron product was developed and tested carefully to provide all features necessary to ensure its compliance with electrical safety requirements. It was also designed for a long fault-free life. However, the life expectancy of your product can be drastically reduced by improper treatment during unpacking and installation. Therefore, in the interest of your own safety and of the correct operation of your new Kontron product, you are requested to conform with the following guidelines.

High Voltage Safety Instructions

As a precaution and in case of danger, the power connector must be easily accessible. The power connector is the product's main disconnect device.

CAUTION

Warning

All operations on this product must be carried out by sufficiently skilled personnel only.

CAUTION



Electric Shock!

Before installing a non hot-swappable Kontron product into a system always ensure that your mains power is switched off. This also applies to the installation of piggybacks. Serious electrical shock hazards can exist during all installation, repair, and maintenance operations on this product. Therefore, always unplug the power cable and any other cables which provide external voltages before performing any work on this product.

Earth ground connection to vehicle's chassis or a central grounding point shall remain connected. The earth ground cable shall be the last cable to be disconnected or the first cable to be connected when performing installation or removal procedures on this product.

Special Handling and Unpacking Instruction

NOTICE



ESD Sensitive Device!

Electronic boards and their components are sensitive to static electricity. Therefore, care must be taken during all handling operations and inspections of this product, in order to ensure product integrity at all times.

Do not handle this product out of its protective enclosure while it is not used for operational purposes unless it is otherwise protected.

Whenever possible, unpack or pack this product only at EOS/ESD safe work stations. Where a safe work station is not guaranteed, it is important for the user to be electrically discharged before touching the product with his/her hands or tools. This is most easily done by touching a metal part of your system housing.

It is particularly important to observe standard anti-static precautions when changing piggybacks, ROM devices, jumper settings etc. If the product contains batteries for RTC or memory backup, ensure that the product is not placed on conductive surfaces, including anti-static plastics or sponges. They can cause short circuits and damage the batteries or conductive circuits on the product.

Lithium Battery Precautions

If your product is equipped with a lithium battery, take the following precautions when replacing the battery.

⚠ CAUTION

Danger of explosion if the battery is replaced incorrectly.

- ▶ Replace only with same or equivalent battery type recommended by the manufacturer.
- ▶ Dispose of used batteries according to the manufacturer's instructions.

General Instructions on Usage

In order to maintain Kontron's product warranty, this product must not be altered or modified in any way. Changes or modifications to the product, that are not explicitly approved by Kontron and described in this user guide or received from Kontron Support as a special handling instruction, will void your warranty.

This product should only be installed in or connected to systems that fulfill all necessary technical and specific environmental requirements. This also applies to the operational temperature range of the specific board version that must not be exceeded. If batteries are present, their temperature restrictions must be taken into account.

In performing all necessary installation and application operations, only follow the instructions supplied by the present user guide.

Keep all the original packaging material for future storage or warranty shipments. If it is necessary to store or ship the product then re-pack it in the same manner as it was delivered.

Special care is necessary when handling or unpacking the product. See Special Handling and Unpacking Instruction.

Quality and Environmental Management

Kontron aims to deliver reliable high-end products designed and built for quality, and aims to complying with environmental laws, regulations, and other environmentally oriented requirements. For more information regarding Kontron's quality and environmental responsibilities, visit <http://www.kontron.com/about-kontron/corporate-responsibility/quality-management>.

Disposal and Recycling

Kontron's products are manufactured to satisfy environmental protection requirements where possible. Many of the components used are capable of being recycled. Final disposal of this product after its service life must be accomplished in accordance with applicable country, state, or local laws or regulations.

WEEE Compliance

The Waste Electrical and Electronic Equipment (WEEE) Directive aims to:

- ▶ Reduce waste arising from electrical and electronic equipment (EEE)
- ▶ Make producers of EEE responsible for the environmental impact of their products, especially when the product become waste
- ▶ Encourage separate collection and subsequent treatment, reuse, recovery, recycling and sound environmental disposal of EEE
- ▶ Improve the environmental performance of all those involved during the lifecycle of EEE



Environmental protection is a high priority with Kontron.

Kontron follows the WEEE directive

You are encouraged to return our products for proper disposal.

Table of Contents

Symbols.....	6
For Your Safety	7
High Voltage Safety Instructions	7
Special Handling and Unpacking Instruction	7
Lithium Battery Precautions.....	8
General Instructions on Usage	8
Quality and Environmental Management	8
Disposal and Recycling.....	8
WEEE Compliance.....	8
Table of Contents	9
List of Tables	10
List of Figures	11
1/ Introduction	14
2/ Installation Procedures	15
2.1. Installing the Board	15
2.2. Chassis Safety Standards.....	16
2.3. Lithium Battery Replacement	16
3/ System Specifications	18
3.1. System Block Diagram.....	18
3.2. Component Main Data	19
3.3. Environmental Conditions	20
3.4. Processor Support	20
3.5. System Memory Support	21
3.5.1. Memory Operating Frequencies	21
3.6. On-board Graphics Subsystem.....	21
3.7. Power Supply	22
4/ Connector Locations	23
4.1. Top Side.....	23
4.2. Connector Panel Side.....	26
5/ Connector Definitions	27
6/ I/O-Area Connectors	28
6.1. HDMI Connector (CN22).....	28
6.2. DP Connector (CN20)	29
6.3. DVI-D Connector (CN17)	30
6.4. Ethernet Connectors (CN14 - LAN1 & CN15 - LAN2).....	31
6.5. USB Connectors (I/O Area).....	32
6.6. Serial COM1 Port (CN21).....	34
6.7. Audio Jack (CN18).....	36
6.8. PS/2 Keyboard & Mouse Mini-DIN Connector (CN19).....	37
7/ Internal Connectors	38
7.1. Power Connector	38
7.1.1. 2x12-pin ATX Power Supply Wafer (ATX1).....	38
7.1.2. 2x4-pin ATX Power Supply Wafer (ATX2).....	39
7.1.3. CR2032 Battery Holder (BAT1).....	39
7.2. Fan Wafers (FAN1, FAN2 & FAN3).....	41
7.3. SATA (Serial ATA) Disk Interfaces (SATA1, SATA2, SATA3, SATA4, CN1).....	42

7.4. USB Connectors (Internal) (CN2, CN7, CN8 & CN9).....	44
7.5. Front Panel Audio Connector (CN16).....	46
7.6. Front Panel Pin Header (FP1 & FP2).....	47
7.7. Serial COM2 - COM6 Ports (CN12, CN3, CN4, CN5 & CN6).....	49
7.8. VGA Connector (CN13).....	51
7.9. Digital Input / Output Pin Header (CN10).....	52
7.10. mPCIe Slot Connector (MPCIE1 & MPCIE2).....	53
7.11. SIM Card Socket for MPCIE1 (SIM1).....	57
7.12. PCI Slot (PCI1, PCI2, PCI3 & PCI4).....	58
7.13. PCI Express x4 Slot (PCIE1 & PCIE2).....	61
7.14. PCI Express x16 Slot (PEG1).....	63
7.15. Switches and Jumpers.....	66
7.15.1. Pin-9 Selection for COM3 & COM4 (JP1).....	66
7.15.2. Keyboard Lock Selection (JP2).....	67
7.15.3. mPCIe LED Indicator Jumper (JP3).....	67
7.15.4. Protected RTC Selection (JP4).....	67
7.15.5. mPCIe / mSATA Selection for MPCIE2 & MPCIE1 (JP5 & JP9).....	68
7.15.6. ME F/W Selection (JP6).....	68
7.15.7. AT / ATX Power Mode Selection (JP7).....	69
7.15.8. Clear ME Register (JP8).....	69
7.15.9. PCIe Configuration Setting for PEG1 (JP12).....	69
7.15.10. Terminator Selection for COM1 & COM2 (JP13 & JP14).....	70
7.15.11. Pin-9 Selection for COM1 & COM2 (JP15).....	70
8/ BIOS.....	72
8.1. Starting the uEFI BIOS.....	72
8.2. Setup Menus.....	73
8.2.1. Main Setup Menu.....	73
8.2.2. Advanced Setup Menu.....	75
8.2.3. Power Setup Menu.....	92
8.2.4. Security Setup Menu.....	95
8.2.4.1. Remember the password.....	96
8.2.5. Boot Setup Menu.....	97
8.2.6. Save & Exit Setup Menu.....	98
Appendix A: List of Acronyms.....	99
About Kontron.....	100

List of Tables

Table 1: Component Main Data.....	19
Table 2: Environmental Conditions.....	20
Table 3: Memory Operating Frequencies.....	21
Table 4: Three-displays Configurations.....	21
Table 5: Supply Voltages.....	22
Table 6: Jumper List.....	23
Table 7: Top Side Internal Connector Pin Assignment.....	24
Table 8: Connector Panel Side Connector List.....	26
Table 9: Pin Assignment HDMI Connector CN22.....	28
Table 10: Pin Assignment DP Connector CN20.....	29
Table 11: Pin Assignment DVI-D Connector CN17.....	30
Table 12: Pin Assignment Ethernet Connectors CN14 - LAN1, CN15 - LAN2.....	31

Table 13: Pin Assignment USB3.0 Connector CN14 - USB 3.0 Port 3, 4 & CN15 - USB 3.0 Port 1, 2.....	32
Table 14: Signal Description.....	32
Table 15: Pin Assignment Serial COM1 Port CN21.....	34
Table 16: Signal Description.....	34
Table 17: Pin Assignment Audio Jack CN18.....	36
Table 18: Pin Assignment PS/2 Keyboard & Mouse Mini-DIN Connector CN19.....	37
Table 19: Pin Assignment ATX1.....	38
Table 20: Pin Assignment ATX2.....	39
Table 21: Pin Assignment BAT1.....	39
Table 22: 4-pin Mode FAN1, FAN2, FAN3.....	41
Table 23: 3-pin Mode FAN1, FAN2, FAN3.....	41
Table 24: Signal description.....	41
Table 25: Pin Assignment SATA1, SATA2, SATA3, SATA4.....	42
Table 26: Signal Description.....	42
Table 27: Pin Assignment CN1.....	43
Table 28: Pin Assignment CN2.....	44
Table 29: Pin Assignment CN7, CN8, CN9.....	45
Table 30: Signal Description.....	45
Table 31: Pin Assignment CN16.....	46
Table 32: Pin Assignment FP1.....	47
Table 33: Signal Description.....	47
Table 34: Pin Assignment FP2.....	47
Table 35: Signal Description.....	48
Table 36: Pin Assignment COM2 (CN12).....	49
Table 37: Pin Assignment COM3, COM4 (CN3, CN4).....	49
Table 38: Pin Assignment COM5, COM6 (CN5, CN6).....	50
Table 39: Signal Description.....	50
Table 40: Pin Assignment CN13.....	51
Table 41: Pin Assignment CN10.....	52
Table 42: Pin Assignment MPCIE1.....	53
Table 43: Pin Assignment MPCIE2.....	54
Table 44: Pin Assignment SIM1.....	57
Table 45: Pin Assignment PCI1, PCI2, PCI3, PCI4.....	58
Table 46: Pin Assignment PCIE1, PCIE2.....	61
Table 47: Pin Assignment PEG1.....	63
Table 48: Pin Assignment JP1.....	66
Table 49: Pin Assignment JP2.....	67
Table 50: Pin Assignment JP3.....	67
Table 51: Pin Assignment JP4.....	67
Table 52: Pin Assignment JP5, JP9.....	68
Table 53: Pin Assignment JP6.....	68
Table 54: Pin Assignment JP7.....	69
Table 55: Pin Assignment JP8.....	69
Table 56: Pin Assignment JP12.....	70
Table 57: Pin Assignment JP13, JP14.....	70
Table 58: Pin Assignment JP15.....	71
Table 59: Font Size Table.....	72
Table 60: Main Setup Menu Sub-Screens and Functions.....	73
Table 61: List of Acronyms.....	99

List of Figures

Figure 1: System Block Diagram ATX-SKL-S.....	18
Figure 2: Top Side.....	23
Figure 3: Connector Panel Side.....	26
Figure 4: HDMI Connector CN22.....	28

Figure 5: DP Connector CN20.....	29
Figure 6: DVI-D Connector CN17.....	30
Figure 7: Ethernet Connectors CN14 - LAN1, CN15 - LAN2.....	31
Figure 8: USB 3.0 Connectors CN14 - USB 3.0 Port 3, 4 & CN15 - USB 3.0 Port 1, 2.....	32
Figure 9: USB 2.0 High Speed Cable.....	32
Figure 10: USB 3.0 High Speed Cable.....	33
Figure 11: Serial COM1 Port CN21.....	34
Figure 12: Audio Jack CN18.....	36
Figure 13: PS/2 Keyboard & Mouse Mini-DIN Connector CN19.....	37
Figure 14: 2x12-pin ATX Power Supply Wafer ATX1.....	38
Figure 15: 2x4-pin ATX Power Supply Wafer ATX2.....	39
Figure 16: CR2032 Battery Holder BAT1.....	39
Figure 17: Fan Wafer FAN1, FAN2, FAN3.....	41
Figure 18: SATA Connector SATA1, SATA2, SATA3, SATA4.....	42
Figure 19: SATA Express Connector CN1.....	42
Figure 20: USB 3.0 Port Wafer CN2.....	44
Figure 21: USB 2.0 Port Wafer CN7, CN8, CN9.....	44
Figure 22: Front Panel Audio Connector CN16.....	46
Figure 23: Front Panel Pin Header FP1.....	47
Figure 24: Front Panel Pin Header FP2.....	47
Figure 25: Serial COM COM2 - COM6.....	49
Figure 26: VGA Connector CN13.....	51
Figure 27: Digital Input / Output Pin Header CN10.....	52
Figure 28: mPCIe Slot Connector MPCIE1, MPCIE2.....	53
Figure 29: SIM Card Socket SIM1.....	57
Figure 30: PCI Slot PCI1, PCI2, PCI3, PCI4.....	58
Figure 31: PCI Express x4 Slot PCIE1, PCIE2.....	61
Figure 32: PCI Express x16 Slot PEG1.....	63
Figure 33: Jumper Connector.....	66
Figure 34: Pin-9 Selection JP1.....	66
Figure 35: Keyboard Lock Selection JP2.....	67
Figure 36: mPCIe LED Indicator Jumper JP3.....	67
Figure 37: Protected RTC Selection JP4.....	67
Figure 38: mPCIe / mSATA Selection JP5, JP9.....	68
Figure 39: ME F/W Selection JP6.....	68
Figure 40: AT / ATX Power Mode Selection JP7.....	69
Figure 41: Clear ME Register JP8.....	69
Figure 42: PCIe Configuration Setting JP12.....	69
Figure 43: COM Terminator Selection JP13, JP14.....	70
Figure 44: Pin-9 Selection JP15.....	70
Figure 45: BIOS Main Menu Screen System Data and Time.....	74
Figure 46: BIOS Advanced Menu.....	76
Figure 47: BIOS Advanced Menu - Display Configuration.....	77
Figure 48: BIOS Advanced Menu - Super IO Configuration.....	78
Figure 49: BIOS Advanced Menu - Super IO Configuration - Serial Port 1 Configuration.....	78
Figure 50: BIOS Advanced Menu - Super IO Configuration - Serial Port 2 Configuration.....	79
Figure 51: BIOS Advanced Menu - Super IO Configuration - Serial Port 3 Configuration.....	80
Figure 52: BIOS Advanced Menu - Super IO Configuration - Serial Port 4 Configuration.....	80
Figure 53: BIOS Advanced Menu - Super IO Configuration - Serial Port 5 Configuration.....	81
Figure 54: BIOS Advanced Menu - Super IO Configuration - Serial Port 6 Configuration.....	82
Figure 55: BIOS Advanced Menu - CPU Chipset Configuration.....	83
Figure 56: BIOS Advanced Menu - SATA Configuration.....	84
Figure 57: BIOS Advanced Menu - USB Configuration.....	85
Figure 58: BIOS Advanced Menu - AMT Configuration*.....	86
Figure 59: BIOS Advanced Menu - TPM Configuration*.....	87
Figure 60: BIOS Advanced Menu - DIO Configuration.....	88

Figure 61: BIOS Advanced Menu - H/W Monitor 90

Figure 62: BIOS Power Setup Menu 92

Figure 63: BIOS Power Setup Menu - WatchDog Timer Configuration..... 94

Figure 64: BIOS Boot Setup Menu 95

Figure 65: BIOS Boot Setup Menu..... 97

Figure 66: BIOS Boot Setup Menu 98

1/ Introduction

This user guide describe the ATX-SKL-S board made by Kontron. This board will also be denoted ATX-SKL-S within this user guide.

Use of this user guide implies a basic knowledge of PC-AT hardware and software. This user guide focuses on describing the ATX-SKL-S board's special features and is not intended to be a standard PC-AT textbook.

New users are recommended to study the short installation procedure stated in the following chapter before switching on the power.

All configuration and setup of the CPU board is either carried out automatically or manually by the user via the BIOS setup menus.

Latest revision of this user guide, datasheet, thermal simulations, BIOS, drivers, BSP's (Board Support Packages), mechanical drawings (2D and 3D) can be download from Kontron's Web Page.

2/ Installation Procedures

2.1. Installing the Board

NOTICE



ESD Sensitive Device

Electrostatic discharge (ESD) can damage equipment and impair electrical circuitry.

- ▶ Wear ESD-protective clothing and shoes
- ▶ Wear an ESD-preventive wrist strap attached to a good earth ground
- ▶ Check the resistance value of the wrist strap periodically (1 MΩ to 10 MΩ)
- ▶ Transport and store the board in its antistatic bag
- ▶ Handle the board at an approved ESD workstation
- ▶ Handle the board only by the edges

To get the board running follow these steps. If the board shipped from KONTRON already has components like RAM and CPU cooler mounted, then skip the relevant steps below.

1. Turn off the PSU (Power Supply Unit)

NOTICE

Turn off PSU (Power Supply Unit) completely (no mains power connected to the PSU) or leave the Power Connectors unconnected while configuring the board. Otherwise, components (RAM, LAN cards etc.) might get damaged. Make sure to use a standard ATX PSU and a standard ATX12V PSU with suitable cable kits and PS-ON# active.

NOTICE

The power supply unit shall comply with the requirements as defined in IEC 62368-1 according Clause 6.2.2 to power source category PS2 "Limited Power Source".

2. Insert the DDR4 UDIMM 288-pin module(s)

Be careful to push the memory module in the slot(s) before locking the tabs. For a list of approved UDIMMs contact your Distributor or FAE. See also chapter "System Memory Support". Use UDIMM with the same memory density in each socket!

3. Processor installation

Install the processor in the processor socket. Follow the steps in the delivered manual from the processor manufacturer.

4. Cooler installation

You can connect the cooler fan electrically to the CPU FAN connector.

5. Connecting interfaces

Insert all external cables for hard disk, keyboard etc. A monitor must be connected in order to change BIOS settings.

6. Connect and turn on PSU

Connect PSU to the board by the 2x12-pin ATX wafer connector and 2x4-pin ATX wafer connector.

7. BIOS setup

Enter the BIOS setup by pressing the key during boot up.

Enter "Exit Menu" and Load Setup Defaults.

Refer to the "BIOS Configuration / Setup" section of this manual for details on BIOS setup.



To clear all BIOS setting, including Password protection, activate "Clear CMOS Jumper" for 10 sec (without power connected).

8. Mounting the board in chassis

NOTICE

When mounting the board to chassis etc. please note that the board contains components on both sides of the PCB that can easily be damaged if board is handled without reasonable care. A damaged component can result in malfunction or no function at all.

When fixing the board on a chassis, it is recommended to use screws with an integrated washer and a diameter of > 7 mm. Do not use washers with teeth, as they can damage the PCB and cause short circuits.

2.2. Chassis Safety Standards

Before installing the ATX-SKL-5 in the chassis, users must evaluate the end product to ensure compliance with the requirements of the IEC60950-1 safety standard:

- ▶ The board must be installed in a suitable mechanical, electrical and fire enclosure.
- ▶ The system, in its enclosure, must be evaluated for temperature and airflow considerations.
- ▶ The board must be powered by a CSA or UL approved power supply that limits the maximum input current.
- ▶ For interfaces having a power pin such as external power or fan, ensure that the connectors and wires are suitably rated. All connections from and to the product shall be with SELV circuits only.
- ▶ Wires have suitable rating to withstand the maximum available power.
- ▶ The peripheral device enclosure fulfils the IEC60950-1 fire protecting requirements.

2.3. Lithium Battery Replacement

If replacing the lithium battery follow the replacement precautions stated in the notification below:

⚠ CAUTION

Danger of explosion if the lithium battery is incorrectly replaced.

- ▶ Replace only with the same or equivalent type recommended by the manufacturer
- ▶ Dispose of used batteries according to the manufacturer's instructions

VORSICHT! Explosionsgefahr bei unsachgemäßem Austausch der Batterie.

- ▶ Ersatz nur durch denselben oder einen vom Hersteller empfohlenen gleichwertigen Typ
- ▶ Entsorgung gebrauchter Batterien nach Angaben des Herstellers

ATTENTION! Risque d'explosion avec l'échange inadéquat de la batterie.

- ▶ Remplacement seulement par le même ou un type équivalent recommandé par le producteur
- ▶ L'évacuation des batteries usagées conformément à des indications du fabricant

PRECAUCION! Peligro de explosión si la batería se sustituye incorrectamente.

- ▶ Sustituya solamente por el mismo o tipo equivalente recomendado por el fabricante
- ▶ Disponga las baterías usadas según las instrucciones del fabricante

ADVARSEL! Lithiumbatteri – Eksplosionsfare ved fejlagtig håndtering.

- ▶ Udskiftning må kun ske med batteri af samme fabrikat og type

-
- ▶ Levér det brugte batteri tilbage til leverandøren

ADVARSEL! Eksplosjonsfare ved feilaktig skifte av batteri.

- ▶ Benytt samme batteritype eller en tilsvarende type anbefalt av apparatfabrikanten
- ▶ Brukte batterier kasseres i henhold til fabrikantens instruksjoner

VARNING! Explosionsfara vid felaktigt batteribyte.

- ▶ Använd samma batterityp eller en ekvivalent typ som rekommenderas av apparattillverkaren
- ▶ Kassera använt batteri enligt fabrikantens instruktion

VAROITUS! Paristo voi räjähtää, jos se on virheellisesti asennettu.

- ▶ Vaihda paristo ainoastaan lalteval- mistajan suosittelemaan tyyppiln
 - ▶ Hävitä käytetty paristo valmistajan ohjeiden mukaisesti
-

3/ System Specifications

3.1. System Block Diagram

Figure 1: System Block Diagram ATX-SKL-S

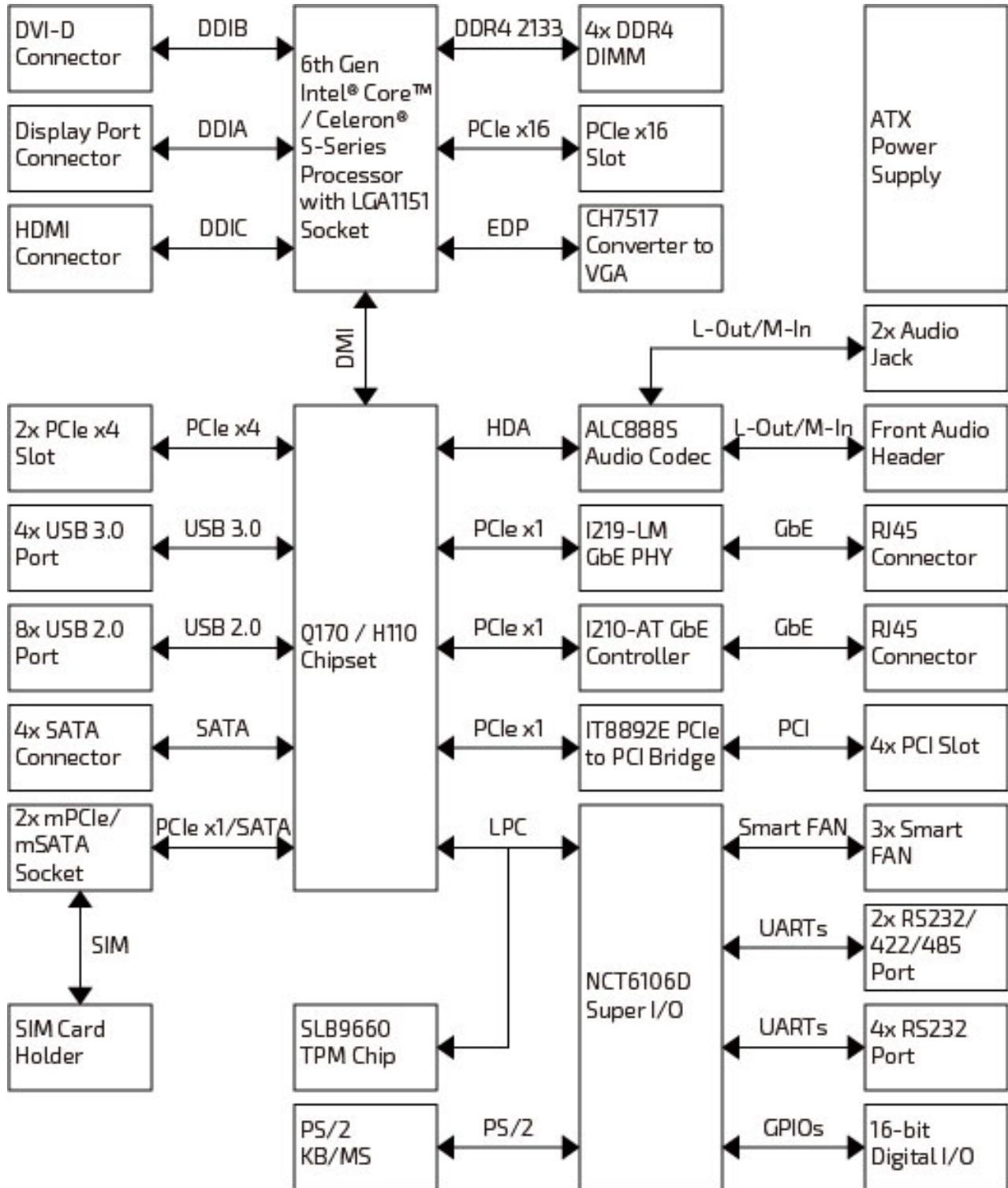

3.2. Component Main Data

The table below summarizes the features of the ATX-SKL-S motherboard.

Table 1: Component Main Data

System	
Processor	6th Gen Intel® Core™ / Celeron® S-Series Processors (FCLGA1151 Socket)
Chipset	<ul style="list-style-type: none"> ▶ Intel® Q170 ▶ Intel® H110
Memory	<ul style="list-style-type: none"> ▶ 4x DDR4 UDIMM memory socket (Q170 model) ▶ 2x DDR4 UDIMM memory socket (H110 model)
Video	
Display Interface	<ul style="list-style-type: none"> ▶ 1x DP (on rear) ▶ 1x HDMI (on rear) ▶ 1x DVI-D (on rear) ▶ 1x VGA (by header)
Multiple Display	<ul style="list-style-type: none"> ▶ Triple (model w/ Q170 chipset) ▶ Dual (model w/ H110 chipset)
Audio	
Audio Codec	Realtek ALC888S
Audio Interface	<ul style="list-style-type: none"> ▶ 2x Line-out (1x on rear, 1x by header) ▶ 2x Mic-in (1x on rear, 1x by header)
Network Connection	
Ethernet	2x GbE LAN (RJ45 on rear, 1x Intel® I219-LM, 1x Intel® I210-AT)
Peripheral Connection	
USB	<ul style="list-style-type: none"> ▶ 6x USB 3.0 (4x Type A on rear, 2x by header, for Q170 model) ▶ 4x USB 3.0 (Type A on rear, for H110 model) ▶ 6x USB 2.0 (by header, for Q170 model) ▶ 4x USB 2.0 (by header, for H110 model)
Serial Port	<ul style="list-style-type: none"> ▶ 2x RS232/422/485 (1x DB9 on rear, 1x by header, w/ power selection) ▶ 4x RS232 (by header, 2x w/ power selection)
Other I/Os	<ul style="list-style-type: none"> ▶ 1x PS/2 Keyboard (Mini-DIN on rear) ▶ 1x PS/2 Mouse (Mini-DIN on rear) ▶ 1x 16-bit DIO (by header)
Storage & Expansion	
Storage & Expansion	<ul style="list-style-type: none"> ▶ 4x SATA (RAID support for Q170 model) ▶ 2x mSATA / mPCIe (1x full size, 1x half size, for Q170 model) ▶ 1x mPCIe (full size, for H110 model) ▶ 4x PCI (32-bit / 33 MHz) ▶ 2x PCIe x4 (H110 models support x1 signal only) ▶ 1x PCIe x16 ▶ 1x SIM Card Cage

Power	
Connector & Input Voltage	<ul style="list-style-type: none"> ▶ 2x12-pin ATX connector (DC +5 V / -5 V / +12 V / -12 V / +3.3 V / 5 VSB) ▶ 2x4-pin ATX connector (DC 12 V)
Firmware	
BIOS	AMI uEFI BIOS w/ 128 Mb SPI Flash
Watchdog	Programmable WDT to generate system reset event
H/W Monitor	Input & Core Voltages, CPU & System Temperatures
Real Time Clock	Chipset integrated RTC
TPM	Supported for Q170 model (Infineon SLB 9660 TPM 1.2)
System Control & Monitoring	
FP Header	<ul style="list-style-type: none"> ▶ 1x Header for Reset button, HDD LED & External Speaker ▶ 1x Header for Power button, Power LED & SM bus
Cooling	
FAN	<ul style="list-style-type: none"> ▶ 1x Wafer for CPU Smart Fan ▶ 1x Wafer for System Smart Fan ▶ 1x Wafer for AUX Smart Fan
Software	
OS Support	Windows 7, Windows 8, Windows 10, Linux
Mechanical	
Dimension (L x W)	ATX (304.8 mm x 244 mm / 12" x 9.6")

3.3. Environmental Conditions

The ATX-SKL-S is compliant with the following environmental conditions. It is the customer's responsibility to provide sufficient airflow around each of the components to keep them within the allowed temperature range.

Table 2: Environmental Conditions

Operating Temperature	0 °C ~ 60 °C / 32 °F ~ 140 °F (Standard) -20 °C ~ 70 °C / -4 °F ~ 158 °F (Extended)
Storage Temperature	-20 °C ~ 80 °C / -4 °F ~ 176 °F (Standard) -40 °C ~ 85 °C / -40 °F ~ 185 °F (Extended)
Humidity	0 % ~ 95 %

3.4. Processor Support

The ATX-SKL-S is designed to support the following processors which are connected to a discrete Intel® H110 or Q170 Chipset Platform Controller Hub on the motherboard.

- ▶ Intel® Core i7, i5, i3 & Celeron® processors (FCLGA1151 Socket, TDP up to 95 W)

Sufficient cooling must be applied to the CPU in order to remove the effect defined as TDP (Thermal Design Power). The sufficient cooling is also depending on the worst case maximum ambient operating temperature and the actual worst case load of processor.

3.5. System Memory Support

The ATX-SKL-S has up to four DDR4 UDIMM sockets. The sockets support the following memory features:

- ▶ 4x DDR4 UDIMM, 1.2 V for Q170 model
- ▶ 2x DDR4 UDIMM, 1.2 V for H110 model
- ▶ Up to 64 GB
- ▶ Dual channel, 288-pin, 1866 / 2133 MT/s
- ▶ SPD timing supported
- ▶ ECC supported

The installed DDR4 UDIMM should support the Serial Presence Detect (SPD) data structure. This allows the BIOS to read and configure the memory controller for optimal performance. If non-SPD memory is used, the BIOS will attempt to configure the memory settings, but performance and reliability may be impacted, or the board may not be able to boot totally.

3.5.1. Memory Operating Frequencies

In all modes, the frequency of system memory is the lowest frequency of all the memory modules placed in the system. Each memory module's frequency can be determined through the SPD registers on the memory modules.

The table below lists the resulting operating memory frequencies based on the combination of UDIMMs and processor.

Table 3: Memory Operating Frequencies

UDIMM Type	Module Name	Memory Data Transfer (MT/s)	Processor System Bus Frequency (MHz)	Resulting Memory Clock Frequency (MHz)	Peak Transfer Rate (MB/s)
DDR4 1866	PC4-1866	1867	933	233	14933
DDR4 2133	PC4-2133	2133	1067	267	17067

Memory modules have in general a much lower longevity than embedded motherboards, and therefore EOL of modules can be expected several times during lifetime of the motherboard.

As a minimum it is recommend using Kontron memory modules for prototype system(s) in order to prove stability of the system and as for reference.

For volume production you might request to test and qualify other types of RAM. In order to qualify RAM it is recommend configuring 3 systems running RAM Stress Test program in heat chamber at 60° C for a minimum of 24 hours.

3.6. On-board Graphics Subsystem

The ATX-SKL-S supports Intel® HD Graphics technology for high quality graphics capabilities. The model with Intel® H110 chipset supports two displays pipes while that with Intel® Q170 chipset supports three displays pipes.

Up to three displays can be used simultaneously and be used to implement independent or cloned display configuration.

Table 4: Three-displays Configurations

Display 1	Display 2	Display 3	Max. Resolution (Px) at 60 Hz		
			Display 1	Display 2	Display 3
DP	HDMI	DVI-D	4096 x 2304	2560 x 1600	1920 x 1200
DP	HDMI	VGA	4096 x 2304	2560 x 1600	1920 x 1200
DP	DVI-D	VGA	4096 x 2304	1920 x 1200	1920 x 1200
HDMI	DVI-D	VGA	2560 x 1600	1920 x 1200	1920 x 1200

3.7. Power Supply

In order to ensure safe operation of the board, the input power supply must monitor the supply voltage and shut down if the supply is out of range – refer to the actual power supply specification. Please note, in order to keep the power consumption to a minimal level, boards do not implement a guaranteed minimum load. In some cases, this can lead to compatibility problems with ATX power supplies that require a minimum load to stay in regulation. The ATX-SKL-S board must be powered through the ATX+12V-8p (8-pole) connector using standard ATX12V power supply and through the ATX-24p (24-pole) connector using standard ATX power supply.

ATX12V supply: ATX+12V-8p connector must be used in according to the ATX12V PSU standard.

ATX supply: ATX-24p connector must be used in according to the ATX PSU standard.

NOTICE

Hot Plugging power supply is not supported. Hot plugging might damage the board.

The requirements to the voltages of ATX power supply are as follows:

Table 5: Supply Voltages

Supply	Min.	Max.	Note
VCC3.3	3.135 V	3.265 V	Should be $\pm 5\%$ for compliance with the ATX specification
Vcc	4.75 V	5.25 V	Should be $\pm 5\%$ for compliance with the ATX specification. Should be minimum 5.00 V measured at USB connectors in order to meet the requirements of USB standard.
+12 V	11.4 V	12.6 V	Should be $\pm 5\%$ for compliance with the ATX specification
-12 V	-13.2 V	-10.8 V	Should be $\pm 10\%$ for compliance with the ATX specification
-5 V	-5.50 V	-4.5 V	Should be $\pm 10\%$ for compliance with the ATX specification
5VSB	4.75 V	5.25 V	Should be $\pm 5\%$ for compliance with the ATX specification

4/ Connector Locations

4.1. Top Side

Figure 2: Top Side

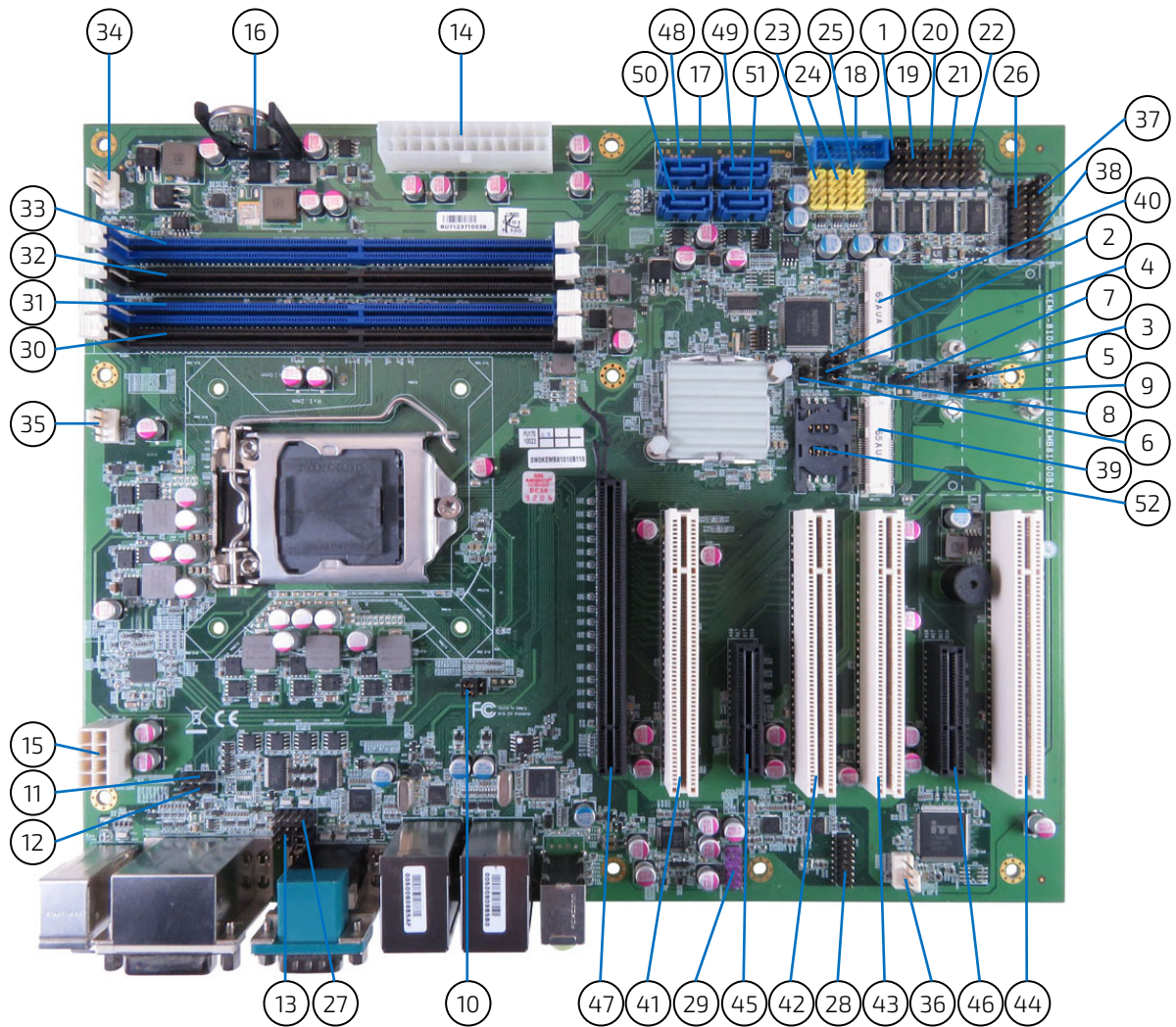

Table 6: Jumper List

Item	Designation	Description	See Chapter
1	JP1	Pin-9 Selection for COM3 & COM4	7.15.1
2	JP2	Keyboard Lock Selection	7.15.2
3	JP3	mPCIe LED Indicator Pin Header	7.15.3
4	JP4	Protected RTC Selection	7.15.4
5	JP5	mPCIe / mSATA Selection for MPCIE2 (Q170 models only)	7.15.5
6	JP6	Flash Descriptor Security Override Selection	7.15.6
7	JP7	AT / ATX Power Mode Selection	7.15.7
8	JP8	ME F/W Selection	7.15.8
9	JP9	mPCIe / mSATA Selection for MPCIE1 (Q170 models only)	7.15.5
10	JP12	PCIe Configuration Setting for PEG1 (Q170 models only)	7.15.9

Item	Designation	Description	See Chapter
11	JP13	Terminator Selection for COM1	7.15.10
12	JP14	Terminator Selection for COM2	7.15.10
13	JP15	Pin-9 Selection for COM1 & COM2	7.15.11

Table 7: Top Side Internal Connector Pin Assignment

Item	Designation	Description	See Chapter
14	ATX1	2x12-pin ATX Power Supply Wafer	7.1.1
15	ATX2	2x4-pin ATX Power Supply Wafer	7.1.2
16	BAT1	CR2032 Battery Holder	7.1.3
17	CN1	SATA Express Connector (Q170 models only)	7.3
18	CN2	USB3.0 Ports-5, 6 Box Header (Q170 models only)	7.4
19	CN3	RS-232 COM3 Pin Header	7.7
20	CN4	RS-232 COM4 Pin Header	7.7
21	CN5	RS-232 COM5 Pin Header	7.7
22	CN6	RS-232 COM6 Pin Header	7.7
23	CN7	USB2.0 Port-7, 8 Pin Header	7.4
24	CN8	USB2.0 Port-11, 12 Pin Header (Q170 models only)	7.4
25	CN9	USB2.0 Port-9, 10 Pin Header	7.4
26	CN10	16-bit Digital Input / Output Pin Header	7.9
27	CN12	RS-232/422/485 COM2 Pin Header	7.7
28	CN13	VGA Header	7.8
29	CN16	Front Panel Audio Pin Header	7.5
30	DIMM1	Channel-A, DIMM-0 DDR4 DIMM Slot	3.5
31	DIMM2	Channel-A, DIMM-1 DDR4 DIMM Slot (Q170 models only)	3.5
32	DIMM3	Channel-B, DIMM-0 DDR4 DIMM Slot	3.5
33	DIMM4	Channel-B, DIMM-1 DDR4 DIMM Slot (Q170 models only)	3.5
34	FAN1	System FAN Wafer	7.2
35	FAN2	CPU FAN Wafer	7.2
36	FAN3	AUX FAN Wafer	7.2
37	FP1	Front Panel Pin Header 1	7.6
38	FP2	Front Panel Pin Header 2	7.6
39	MPCIE1	Full Size mPCIe / mSATA Socket	7.10
40	MPCIE2	Half Size mPCIe / mSATA Socket (Q170 models only)	7.10
41	PCI1	32-bit, 33MHz PCI Slot 1	7.12
42	PCI2	32-bit, 33MHz PCI Slot 2	7.12
43	PCI3	32-bit, 33MHz PCI Slot 3	7.12
44	PCI4	32-bit, 33MHz PCI Slot 4	7.12
45	PCIE1	PCIEx4 Slot 1	7.13
46	PCIE2	PCIEx4 Slot 2	7.13
47	PEG1	PCIEx16 Slot	7.14
48	SATA1	Serial ATA Port-1 Connector (H110 models only)	7.3
49	SATA2	Serial ATA Port-2 Connector (H110 models only)	7.3

Item	Designation	Description	See Chapter
50	SATA3	Serial ATA Port-3 Connector	7.3
51	SATA4	Serial ATA Port-4 Connector	7.3
52	SIM1	SIM Card Holder for MPCIE1	7.11

4.2. Connector Panel Side

Figure 3: Connector Panel Side

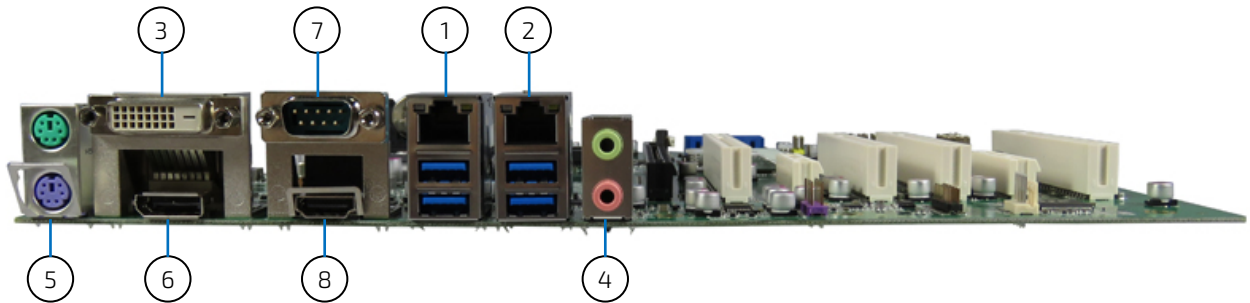

Table 8: Connector Panel Side Connector List

Item	Designation	Description	See Chapter
1	CN14	GbE LAN1 & USB3.0 Port-3, 4	6.4 & 6.5
2	CN15	GbE LAN2 & USB3.0 Port-1, 2	6.4 & 6.5
3	CN17	DVI-D Connector	6.3
4	CN18	Line-Out & Mic-In Audio Jacks	6.7
5	CN19	PS/2 Keyboard & Mouse Mini-DIN Connector	6.8
6	CN20	DisplayPort Connector	6.2
7	CN21	RS-232/422/485 COM1 Connector	6.6
8	CN22	HDMI Connector	6.1

5/ Connector Definitions

The following defined terms are used within this user guide to give more information concerning the pin assignment and to describe the connector's signals.

Defined Term	Description
Pin	Shows the pin numbers in the connector
Signal	The abbreviated name of the signal at the current pin The notation "XX#" states that the signal "XX" is active low
Note	Special remarks concerning the signal
Designation	Type and number of item described
See Chapter	Number of the chapter within this user guide containing a detailed description

The abbreviation TBD is used for specifications that are not available yet or which are not sufficiently specified by the component vendors.

6/ I/O-Area Connectors

6.1. HDMI Connector (CN22)

The HDMI connector is based on standard HDMI type A.

Figure 4: HDMI Connector CN22

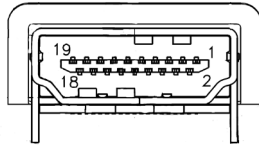

Table 9: Pin Assignment HDMI Connector CN22

Pin	Signal	Description	Note
1	TMD_Data2+		
2	GNG		
3	TMD_Data2-		
4	TMD Data1+		
5	GND		
6	TMD_Data1-		
7	TMD_Data0+		
8	GND		
9	TMD_Data0-		
10	TMD_CLK+		
11	GND		
12	TMD_CLK-		
13	CEC		
14	Reserved		
15	DDC_CLK		
16	DDC_DATA		
17	GND		
18	5 V		
19	HPET		

6.2. DP Connector (CN20)

The DP (DisplayPort) connector is based on standard DP female port.

Figure 5: DP Connector CN20

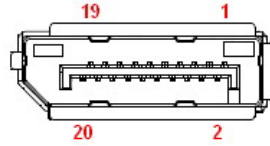

Table 10: Pin Assignment DP Connector CN20

Pin	Signal	Description	Note
1	TX0+		
2	GND		
3	TX0-		
4	TX1+		
5	GND		
6	TX1-		
7	TX2+		
8	GND		
9	TX2-		
10	TX3+		
11	GND		
12	TX3-		
13	GND		
14	GND		
15	AUX+		
16	GND		
17	AUX-		
18	HPD		
19	GND		
20	PWR		

6.3. DVI-D Connector (CN17)

The external I/O connector panel supports one DVI-D female port.

Figure 6: DVI-D Connector CN17

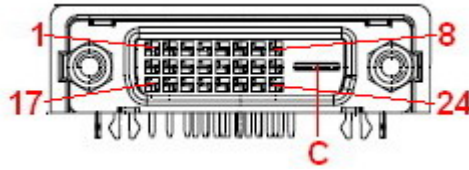

Table 11: Pin Assignment DVI-D Connector CN17

Pin	Signal	Description	Note
1	TX2-		
2	TX2+		
3	GND		
4	NC		
5	NC		
6	DDC_CLK		
7	DDC_DATA		
8	NC		
9	TX1-		
10	TX1+		
11	GND		
12	NC		
13	NC		
14	+5V		
15	GND		
16	HTPLG		
17	TX0-		
18	TX0+		
19	GND		
20	NC		
21	NC		
22	GND		
23	TXC+		
24	TXC-		
C	GND		

6.4. Ethernet Connectors (CN14 - LAN1 & CN15 - LAN2)

The ATX-SKL-S supports two channels of 10/100/1000 Mbit Ethernet, which are based Intel® I219-LM and Intel® I210-AT controllers.

In order to achieve the specified performance of the Ethernet port, Category 5 twisted pair cables must be used with 10/100 MByte and Category 5E, 6 or 6E with 1 Gbit LAN networks.

The signals for the Ethernet ports are as follows:

Figure 7: Ethernet Connectors CN14 - LAN1, CN15 - LAN2

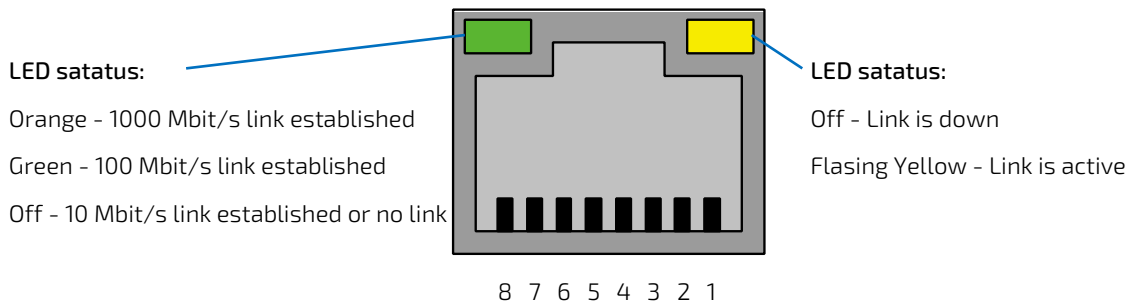

Table 12: Pin Assignment Ethernet Connectors CN14 - LAN1, CN15 - LAN2

Pin	Signal	Note
1	MDI[0]+	
2	MDI[0]-	
3	MDI[1]+	
4	MDI[1]-	
5	MDI[2]+	
6	MDI[2]-	
7	MDI[3]+	
8	MDI[3]-	

Signal Description

Signal	Description
MDI[0]+ / MDI[0]-	In MDI mode, this is the first pair in 1000Base-T, i.e. the BI_DA+/- pair, and is the transmit pair in 10Base-T and 100Base-TX. In MDI crossover mode, this pair acts as the BI_DB+/- pair, and is the receive pair in 10Base-T and 100Base-TX.
MDI[1]+ / MDI[1]-	In MDI mode, this is the second pair in 1000Base-T, i.e. the BI_DB+/- pair, and is the receive pair in 10Base-T and 100Base-TX. In MDI crossover mode, this pair acts as the BI_DA+/- pair, and is the transmit pair in 10Base-T and 100Base-TX.
MDI[2]+ / MDI[2]-	In MDI mode, this is the third pair in 1000Base-T, i.e. the BI_DC+/- pair. In MDI crossover mode, this pair acts as the BI_DD+/- pair.
MDI[3]+ / MDI[3]-	In MDI mode, this is the fourth pair in 1000Base-T, i.e. the BI_DD+/- pair. In MDI crossover mode, this pair acts as the BI_DC+/- pair.

'MDI' - media dependent Interface

6.5. USB Connectors (I/O Area)

The external I/O connector panel supports two dual USB 3.0 connectors.



USB3.0 ports are backward compatible with USB2.0.

Figure 8: USB 3.0 Connectors CN14 - USB 3.0 Port 3, 4 & CN15 - USB 3.0 Port 1, 2

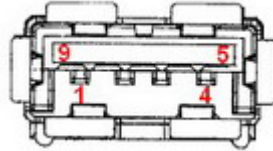

Table 13: Pin Assignment USB3.0 Connector CN14 - USB 3.0 Port 3, 4 & CN15 - USB 3.0 Port 1, 2

Pin	Signal	Note
1	+USBVCC	+5 V Supply for USB device
2	USB_A-	USB 2.0 Differential Pair (-)
3	USB_A+	USB 2.0 Differential Pair (+)
4	GND	
5	USB3_SSRX-	USB 3.0 Rx. Differential Pair (-)
6	USB3_SSRX+	USB 3.0 Rx. Differential Pair (+)
7	GND	
8	USB3_SSTX-	USB 3.0 Tx. Differential Pair (-)
9	USB3_SSTX+	USB 3.0 Tx. Differential Pair (+)

Table 14: Signal Description

Signal	Description
USB3_SSTX+, USB3_SSTX-, USB3_SSRX+, USB3_SSRX-, USB_A-, USB_A+	Differential pair works as serial differential receive/transmit data lines.
+USBVCC	5 V supply for external devices. VCC is supplied during power-down to allow wakeup on USB device activity. Protected by a 1A current limiting IC covering each of the USB port.

For HiSpeed rates it is required to use a USB cable, which is specified in USB 2.0 standard:

Figure 9: USB 2.0 High Speed Cable

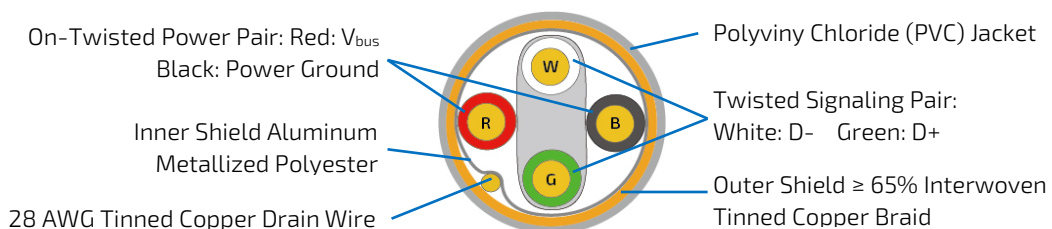

For USB 3.0 cabling it is required to use only HiSpeed USB cable, specified in USB 3.0 standard:

Figure 10: USB 3.0 High Speed Cable

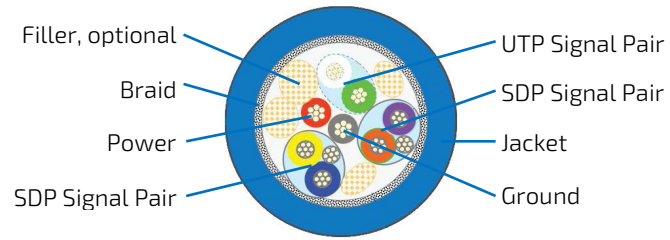

6.6. Serial COM1 Port (CN21)

The external I/O connector panel supports one DB-9 RS-232/422/485 COM male port.

Figure 11: Serial COM1 Port CN21

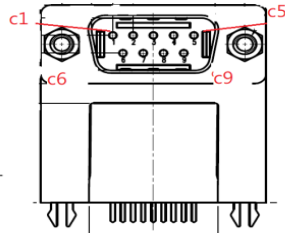

Table 15: Pin Assignment Serial COM1 Port CN21

Pin	RS232 Signal	RS422 Signal	Half Duplex RS485 Signal	Full Duplex RS485 Signal	Note
B1	DCD	TX-	DATA-	TX-	
B2	RXD	TX+	DATA+	RX+	
B3	TXD	RX+	N/A	TX+	
B4	DTR	RX-	N/A	RX-	
B5	GND	GND	GND	GND	
B6	DSR	N/A	N/A	N/A	
B7	RTS	N/A	N/A	N/A	
B8	CTS	N/A	N/A	N/A	
B9	RI*	N/A	N/A	N/A	



*: Pin configuration can be selected by Jumper JP15.



RS232 / 422 / 485 can be selected in BIOS setup.

Table 16: Signal Description

Signal	Description
TXD	Transmitted Data, sends data to the communications link. The signal is set to the marking state (-12 V) on hardware reset when the transmitter is empty or when loop mode operation is initiated.
RXD	Received Data, receives data from the communications link.
DTR	Data Terminal Ready, indicates to the modem etc. that the on-board UART is ready to establish communication link.
DSR	Data Set Ready, indicates that the modem etc. is ready to establish a communications link.
RTS	Request To Send, indicates to the modem etc. that the on-board UART is ready to exchange data.
CTS	Clear To Send, indicates that the modem or data set is ready to exchange data.

Signal	Description
DCD	Data Carrier Detect, indicates that the modem or data set has detected the data carrier.
RI	Ring Indicator, indicates that the modem has received a ringing signal from the telephone line.
TX+/-	Transmitted Data differential pair sends data to the communications link.
RX+/-	Received Data differential pair receives data from the communications link.
GND	Power Supply GND signal

6.7. Audio Jack (CN18)

The external I/O connector panel supports one 3.5 mm dual-port Azalia audio phone jack for headset and microphone.

Figure 12: Audio Jack CN18

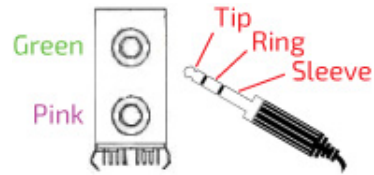

Table 17: Pin Assignment Audio Jack CN18

Pin	Signal	Note
Top		
Tip	Line-Out_L	
Ring	Line-Out_R	
Sleeve	GND	
Bottom		
Tip	Mic-In_L	
Ring	Mic-In_R	
Sleeve	GND	

6.8. PS/2 Keyboard & Mouse Mini-DIN Connector (CN19)

The external I/O connector panel supports one dual-port PS/2 keyboard & mouse Mini-DIN connector.

Figure 13: PS/2 Keyboard & Mouse Mini-DIN Connector CN19

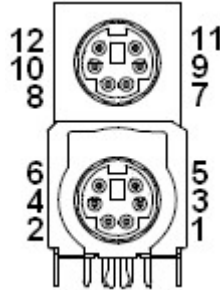

Table 18: Pin Assignment PS/2 Keyboard & Mouse Mini-DIN Connector CN19

Pin	Signal	Description
Top		
7	MSDAT	Mouse Data
8	NC	No Connect
9	GND	Ground
10	MS5V	+5VSB Power Source
11	MSCLK	Mouse Clock
12	NC	No Connect
Bottom		
1	KBDAT	Keyboard Data
2	NC	No Connect
3	GND	Ground
4	KB5V	+5VSB Power Source
5	KBCLK	Keyboard Clock
6	NC	No Connect

7/ Internal Connectors

7.1. Power Connector

Power connector must be used to supply the board with ATX power supply.

NOTICE

Hot plugging any of the power connector is not allowed.

Hot plugging might damage the board. In other words, turn off main supply etc. to make sure all the power lines are turned off when connecting to the motherboard.

7.1.1. 2x12-pin ATX Power Supply Wafer (ATX1)

Figure 14: 2x12-pin ATX Power Supply Wafer ATX1

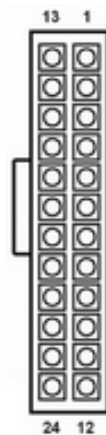

Table 19: Pin Assignment ATX1

Pin	Signal	Description
1	+3.3V	Power +3.3 V
2	+3.3V	Power +3.3 V
3	GND	Ground
4	+5V	Power +5 V
5	GND	Ground
6	+5V	Power +5 V
7	GND	Ground
8	POWER OK	Power Good
9	+5VSB	+5 V Standby
10	+12V	Power +12 V
11	+12V	Power +12 V
12	+3.3V	Power +3.3 V
13	+3.3V	Power +3.3 V
14	-12V	Power -12 V
15	GND	Ground
16	PS_ON	Power On
17	GND	Ground
18	GND	Ground

Pin	Signal	Description
19	GND	Ground
20	-5V	Power -5 V
21	+5V	Power +5 V
22	+5V	Power +5 V
23	+5V	Power +5 V
24	GND	Ground

7.1.2. 2x4-pin ATX Power Supply Wafer (ATX2)

Figure 15: 2x4-pin ATX Power Supply Wafer ATX2

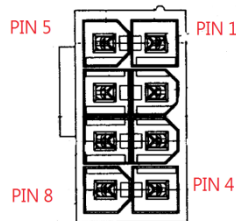

Table 20: Pin Assignment ATX2

Pin	Signal	Description
1	GND	Ground
2	GND	Ground
3	GND	Ground
4	GND	Ground
5	+12V	Power +12 V
6	+12V	Power +12 V
7	+12V	Power +12 V
8	+12V	Power +12 V

7.1.3. CR2032 Battery Holder (BAT1)

Figure 16: CR2032 Battery Holder BAT1

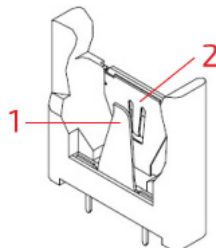

Table 21: Pin Assignment BAT1

Pin	Signal	Description
1	Battery+	

Pin	Signal	Description
2	Battery-	

7.2. Fan Wafers (FAN1, FAN2 & FAN3)

The CPU FAN Wafer (FAN2) is used for the connection of the FAN for the CPU while the System FAN Wafer (FAN1) and AUX FAN Wafer (FAN3) for the connection of the FAN for the system.

The 4-pin wafer is recommended to be used for driving 4-wire type FAN in order to implement FAN speed control. 3-wire Fan support is also possible, but no fan speed control is integrated.

Figure 17: Fan Wafer FAN1, FAN2, FAN3

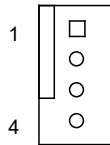

Table 22: 4-pin Mode FAN1, FAN2, FAN3

Pin	Signal	Description
1	GND	Ground
2	+12V	Power +12 V
3	SENSE	Sense signal
4	PWM	PWM output

Table 23: 3-pin Mode FAN1, FAN2, FAN3

Pin	Signal	Description
1	GND	Ground
2	+12V	Power +12 V
3	SENSE	Sense signal
4	-	Not used

Table 24: Signal description

Signal	Description
GND	Power Supply GND signal
12 V	+12 V supply for fan. A maximum of 2000 mA can be supplied from this pin.
SENSE	Sense input signal from the fan, for rotation speed supervision RPM (Rotations Per Minute). The signal shall be generated by an open collector transistor or similar.
PWM	PWM output signal for FAN speed control.

7.3. SATA (Serial ATA) Disk Interfaces (SATA1, SATA2, SATA3, SATA4, CN1)

The SATA Port 1, Port 2, Port 3 & Port 4 connectors (SATA1, SATA2, SATA3 & SATA4) supply the data connection for the SATA hard disks and are SATA 2.0 compatible. SATA Port 1 (SATA1) & Port 2 (SATA2) are only for models with Intel® H110 chipset.

The SATA Express connector (CN1) supplies the data connection for both SATA and PCIe storage devices. The SATA Express connector is available only for models with Intel® Q170 chipset.

Figure 18: SATA Connector SATA1, SATA2, SATA3, SATA4

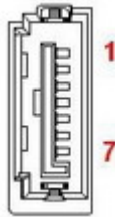

Table 25: Pin Assignment SATA1, SATA2, SATA3, SATA4

Pin	Signal	Note
1	GND	
2	TX+	
3	TX-	
4	GND	
5	RX-	
6	RX+	
7	GND	

Table 26: Signal Description

Signal	Description
RX+ / RX-	Host transmitter differential signal pair
TX+ / TX-	Host receiver differential signal pair

Figure 19: SATA Express Connector CN1

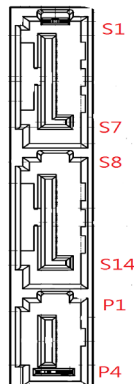

Table 27: Pin Assignment CN1

Pin	Signal	Note
S1	GND	
S2	PETP0	
S3	PETN0	
S4	GND	
S5	PERN0	
S6	PERP0	
S7	GND	
S8	GND	
S9	PETP1	
S10	PETN1	
S11	GND	
S12	PERN1	
S13	PERP1	
S14	GND	
P1	RESERVED	
P2	PERST#	
P3	DEVSLP / CLKREQ#	
P4	IFDET	

7.4. USB Connectors (Internal) (CN2, CN7, CN8 & CN9)

USB 3.0 Port 5 and Port 6 are supplied via the internal pin header CN2 (only for models with Intel® Q170 chipset).

USB 2.0 Port 7 and Port 8 are supplied via the internal pin header CN7.

USB 2.0 Port 9 and Port 10 are supplied via the internal pin header CN9.

USB 2.0 Port 11 and Port 12 are supplied via the internal pin header CN8 (only for models with Intel® Q170 chipset).

Figure 20: USB 3.0 Port Wafer CN2

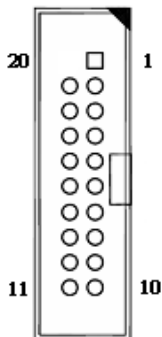

Table 28: Pin Assignment CN2

Pin	Signal	Note
1	USBA_VBUS	+5 V Supply for USB device
2	USBA_RX-	USB 3.0 Rx Differential Pair (-)
3	USBA_RX+	USB 3.0 Rx Differential Pair (+)
4	GND	
5	USBA_TX-	USB 3.0 Tx Differential Pair (-)
6	USBA_TX+	USB 3.0 Tx Differential Pair (+)
7	GND	
8	USBA_D-	USB 2.0 Differential Pair (-)
9	USBA_D+	USB 2.0 Differential Pair (+)
10	NC	
11	USBB_D+	USB 2.0 Differential Pair (+)
12	USBB_D-	USB 2.0 Differential Pair (-)
13	GND	
14	USBB_TX+	USB 3.0 Tx Differential Pair (+)
15	USBB_TX-	USB 3.0 Tx Differential Pair (-)
16	GND	
17	USBB_RX+	USB 3.0 Rx Differential Pair (+)
18	USBB_RX-	USB 3.0 Rx Differential Pair (-)
19	USBB_VBUS	+5 V Supply for USB device
20	KEY	

Figure 21: USB 2.0 Port Wafer CN7, CN8, CN9

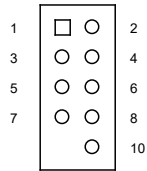

Table 29: Pin Assignment CN7, CN8, CN9

Pin	Signal	Note
1	+VBUS_A	+5 V Supply for USB device
2	+VBUS_B	+5 V Supply for USB device
3	USB_A-	USB 2.0 Differential Pair (-)
4	USB_B-	USB 2.0 Differential Pair (-)
5	USB_A+	USB 2.0 Differential Pair (+)
6	USB_B+	USB 2.0 Differential Pair (+)
7	GND_A	
8	GND_B	
9	KEY	
10	GND	

Table 30: Signal Description

Signal	Description
USBn_VBUS, +VBUS_n	5 V supply for external devices. SB5V is supplied during power down to allow wakeup on USB device activity. Protected by active power switch 1 A fuse for each USB port. (n=A, B)
USBn_Rx-/+, USBn_Tx-/+, USBn_D-/+, USB_n-/+	Differential pair works as serial differential receive/transmit data lines. (n= A, B)

7.5. Front Panel Audio Connector (CN16)

The front panel audio connector provides audio output (Line-Out) and microphone (Mic-In) signals through the wafer CN16.

Figure 22: Front Panel Audio Connector CN16

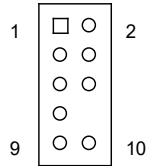

Table 31: Pin Assignment CN16

Pin	Signal	Note
1	MIC2-L	
2	Audio GND	
3	MIC2-R	
4	Audio GND	
5	Line2-R	
6	KIC2_JD	
7	Audio GND	
8	Key	
9	Line2-L	
10	Line2_JD	

7.6. Front Panel Pin Header (FP1 & FP2)

Figure 23: Front Panel Pin Header FP1

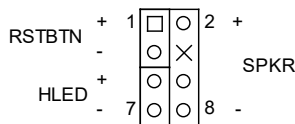

Table 32: Pin Assignment FP1

Pin	Signal	Note
1	Reset Button +	
2	Speaker +	
3	Reset Button -	
4	NC	
5	HDD LED +	
6	Internal Speaker -	
7	HDD LED -	
8	Speaker -	



Internal Buzzer is enabled when Pin6-8 is shorted.

Table 33: Signal Description

Signal	Description
Reset Button -/+	Reset Button. This 2-pin connector is for chassis mounted reset button for system reboot without turning off the system power.
HDD LED -/+	Hard Disk Drive Activity LED. This 2-pin connector is for HDD Activity LED. Connect the HDD Activity LED cable to this connector. The HDD LED lights up or flashes when data is read from or written to the HDD.
Internal Speaker - Speaker -/+	System warning speaker. The speaker allows user to hear beeps and warnings.

Figure 24: Front Panel Pin Header FP2

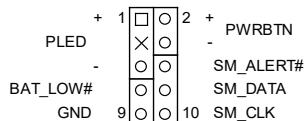

Table 34: Pin Assignment FP2

Pin	Signal	Note
1	Power LED +	

Pin	Signal	Note
2	Power Button +	
3	NC	
4	Power Button -	
5	Power LED -	
6	SM ALERT#	
7	BAT_LOW#	
8	SMBus Data	
9	GND	
10	SMBus Clock	

Table 35: Signal Description

Signal	Description
Power LED -/+	System Power LED. The power LED lights up when users turn on the system power, and blinks when the system is in sleep mode.
Power Button -/+	The 2-pin connector is for the system power button. Pressing the power button turns the system on or puts the system in sleep or soft-off mode depending on the operating system settings. Pressing the power switch for more than four seconds while the system turns from ON to OFF.
SM ALERT#	System Management Bus interrupt signal
BAT_LOW#	This connector indicates when the battery is at low state of charge.
SMBus Data	System Management Bus bidirectional data line
SMBus Clock	System Management Bus bidirectional clock line

7.7. Serial COM2 - COM6 Ports (CN12, CN3, CN4, CN5 & CN6)

One RS232/422/485 COM port is supplied via the internal pin header CN12.

Four RS232 COM ports are supplied via the internal pin header CN3, CN4, CN5 & CN6.

Figure 25: Serial COM COM2 - COM6

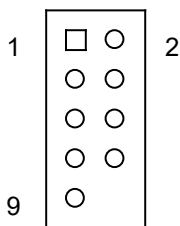

Table 36: Pin Assignment COM2 (CN12)

Pin	RS232 Signal	RS422 Signal	Half Duplex RS485 Signal	Full Duplex RS485 Signal	Note
1	DCD	TX-	DATA-	TX-	
2	RXD	TX+	DATA+	TX+	
3	TDX	RX+	N/A	RX+	
4	DTR	RX-	N/A	RX-	
5	GND	GND	GND	GND	
6	DSR	N/A	N/A	N/A	
7	RTS	N/A	N/A	N/A	
8	CTS	N/A	N/A	N/A	
9	RI / +5V / +12V*	RI / +5V / +12V*	RI / +5V / +12V*	RI / +5V / +12V*	
10	Key	Key	Key	Key	



*: Pin configuration can be selected by Jumper JP14.

Table 37: Pin Assignment COM3, COM4 (CN3, CN4)

Pin	RS232 Signal	Note
1	DCD	
2	RXD	
3	TXD	
4	DTR	
5	GND	
6	DSR	
7	RTS	
8	CTS	
9	RI / +12V / +5V*	

Pin	RS232 Signal	Note
10	NC, Key	



*: Pin configuration can be selected by Jumper JP1.

Table 38: Pin Assignment COM5, COM6 (CN5, CN6)

Pin	RS232 Signal	Note
1	DCD	
2	RXD	
3	TXD	
4	DTR	
5	GND	
6	DSR	
7	RTS	
8	CTS	
9	RI	
10	NC, Key	



The COM ports need to install an OS patch from ITE. The patch is only available for Windows and is not available Linux.

Table 39: Signal Description

Signal	Description
TXD	Transmitted Data, sends data to the communications link. The signal is set to the marking state (-12 V) on hardware reset when the transmitter is empty or when loop mode operation is initiated.
RXD	Received Data, receives data from the communications link.
DTR	Data Terminal Ready, indicates to the modem etc. that the on-board UART is ready to establish communication link.
DSR	Data Set Ready, indicates that the modem etc. is ready to establish a communications link.
RTS	Request To Send, indicates to the modem etc. that the on-board UART is ready to exchange data.
CTS	Clear To Send, indicates that the modem or data set is ready to exchange data.
DCD	Data Carrier Detect, indicates that the modem or data set has detected the data carrier.
RI	Ring Indicator, indicates that the modem has received a ringing signal from the telephone line.
GND	Power Supply GND signal

7.8. VGA Connector (CN13)

One VGA connector is supplied via the internal pin header CN13.

Figure 26: VGA Connector CN13

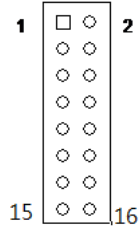

Table 40: Pin Assignment CN13

Pin	Signal	Description
1	Red	Analogue output carrying the red colour values. (75 Ohm cable impedance).
2	Green	Analogue output carrying the green colour values. (75 Ohm cable impedance).
3	Blue	Analogue output carrying the blue colour values. (75 Ohm cable impedance).
4	NC	No Connection
5	GND	Ground
6	GND	Ground
7	GND	Ground
8	GND	Ground
9	5V	5V supply input
10	GND	Ground
11	NC	No Connection
12	DDC_DATA	Display Data Channel Data. Used as data signal to/from monitors with DDC interface.
13	HSYNC	CRT horizontal synchronization output.
14	VSYNC	CRT vertical synchronization output.
15	DDC_CLK	Display Data Channel Clock. Used as clock signal to/from monitors with DDC interface.
16	KEY	

7.9. Digital Input / Output Pin Header (CN10)

Figure 27: Digital Input / Output Pin Header CN10

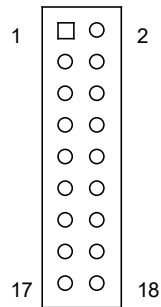

Table 41: Pin Assignment CN10

Pin	Signal	Note
1	DIO_0	
2	DIO_8	
3	DIO_1	
4	DIO_9	
5	DIO_2	
6	DIO_10	
7	DIO_3	
8	DIO_11	
9	DIO_4	
10	DIO_12	
11	DIO_5	
12	DIO_13	
13	DIO_6	
14	DIO_14	
15	DIO_7	
16	DIO_15	
17	+5V	
18	GND	

7.10. mPCIe Slot Connector (MPCIE1 & MPCIE2)

Full-sized Mini-PCI Express V1.2 socket (MPCIE1). Socket MPCIE1 supports mPCIe, mSATA (only models with Intel® Q170 chipset support SATA), USB2.0 and SIM-card socket. The SIM-card socket makes it possible to use a 3G/4G-wireless modem in this mPCIe slot. The USB does support WAKE function.

Half-sized Mini-PCI Express V1.2 socket (MPCIE2) (only models with Intel® Q170 chipset have this socket). Socket MPCIE2 supports mPCIe, mSATA and USB2.0. The USB does support WAKE function.

Figure 28: mPCIe Slot Connector MPCIE1, MPCIE2

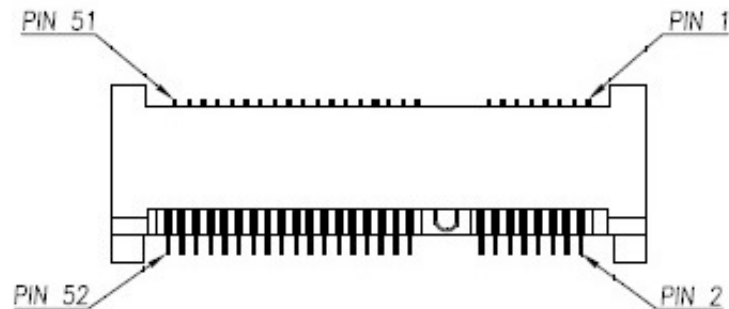

Table 42: Pin Assignment MPCIE1

Pin	Signal	Note
1	WAKE#	
2	+3.3VSB	
3	Reserved	
4	Ground	
5	Reserved	
6	+1.5V	
7	CLKREQ#	
8	UIM_PWR**	
9	Ground	
10	UIM_DATA**	
11	REFCLK-	
12	UIM_CLK**	
13	REFCLK+	
14	UIM_RESET**	
15	Ground	
16	UIM_VPP**	
17	Reserved	
18	Ground	
19	Reserved	
20	W_Disable#	
21	Ground	
22	PERST#	
23	PERn0 / SATA_RX+*	

Pin	Signal	Note
24	+3.3VSB	
25	PERp0 / SATA_RX-*	
26	Ground	
27	Ground	
28	+1.5V	
29	Ground	
30	SMB_CLK	
31	PETn0 / SATA_TX-*	
32	SMB_DATA	
33	PETp0 / SATA_TX+*	
34	Ground	
35	Ground	
36	USB_D-	
37	Ground	
38	USB_D+	
39	+3.3VSB	
40	Ground	
41	+3.3VSB	
42	LED_WWAN#	
43	Ground / NC*	
44	LED_WLAN#	
45	Reserved	
46	LED_WPAN#	
47	Reserved	
48	+1.5V	
49	Reserved	
50	Ground	
51	Reserved	
52	+3.3VSB	



*: Pin configuration can be selected by Jumper JP9.



** : These pins are connected to SIM1 directly.

Table 43: Pin Assignment MPCIE2

Pin	Signal	Note
1	WAKE#	
2	+3.3VSB	

Pin	Signal	Note
3	Reserved	
4	Ground	
5	Reserved	
6	+1.5V	
7	CLKREQ#	
8	Reserved	
9	Ground	
10	Reserved	
11	REFCLK-	
12	Reserved	
13	REFCLK+	
14	Reserved	
15	Ground	
16	Reserved	
17	Reserved	
18	Ground	
19	Reserved	
20	W_Disable#	
21	Ground	
22	PERST#	
23	PERn0 / SATA_RX+*	
24	+3.3VSB	
25	PERp0 / SATA_RX-*	
26	Ground	
27	Ground	
28	+1.5V	
29	Ground	
30	SMB_CLK	
31	PETn0 / SATA_TX-*	
32	SMB_DATA	
33	PETp0 / SATA_TX+*	
34	Ground	
35	Ground	
36	USB_D-	
37	Ground	
38	USB_D+	
39	+3.3VSB	
40	Ground	
41	+3.3VSB	
42	LED_WWAN#	
43	Ground / NC*	
44	LED_WLAN#	

Pin	Signal	Note
45	Reserved	
46	LED_WPAN#	
47	Reserved	
48	+1.5V	
49	Reserved	
50	Ground	
51	Reserved	
52	+3.3VSB	



*: Pin configuration can be selected by Jumper JP5.

7.11. SIM Card Socket for MPCIE1 (SIM1)

Figure 29: SIM Card Socket SIM1



Table 44: Pin Assignment SIM1

Pin	Signal	Description	Note
1	UIM_PWR	Power +5V or +3.3V	
2	UIM_RST	Reset signal	
3	UIM_CLK	Clock signal	
4	GND	Ground	
5	UIM_VPP	Programming voltage input	
6	UIM_DATA	Input or Output for serial data	

7.12. PCI Slot (PCI1, PCI2, PCI3 & PCI4)

The ATX-SKL-S supports four 32-bit 33 MHz PCI cards via Slot PCI1, PCI2, PCI3 & PCI4.

Figure 30: PCI Slot PCI1, PCI2, PCI3, PCI4

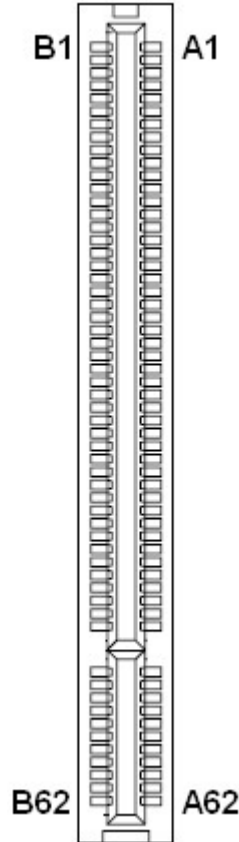

Table 45: Pin Assignment PCI1, PCI2, PCI3, PCI4

Pin	Side B		Side A	
	Signal	Description	Signal	Description
1	-12V	-12 V power	Reserved	
2	Reserved		+12V	+12 V power
3	Ground		Reserved	
4	Reserved		Reserved	
5	+5V	+5 V power	+5V	+5 V power
6	+5V	+5 V power	INTA#	Interrupt A
7	INTB#	Interrupt B	INTC#	Interrupt C
8	INTD#	Interrupt D	+5V	+5 V power
9	Reserved		Reserved	
10	Reserved		+5V	+5 V power
11	Reserved		Reserved	
12	Ground		Ground	
13	Ground		Ground	

Pin	Side B		Side A	
	Signal	Description	Signal	Description
14	Reserved		+3.3VAUX	+3.3 V auxiliary power
15	Ground		RST#	Reset
16	CLK	Clock	+5V	+5 V power
17	Ground		GNT#	Grant PCI use
18	REQ#	Request	Ground	
19	+5V	+5 V power	PME#	Power Management Event
20	AD[31]	Address / Data 31	AD[30]	Address / Data 30
21	AD[29]	Address / Data 29	+3.3V	+3.3 V power
22	Ground		AD[28]	Address / Data 28
23	AD[27]	Address / Data 27	AD[26]	Address / Data 26
24	AD[25]	Address / Data 25	Ground	
25	+3.3V	+3.3 V power	AD[24]	Address / Data 24
26	C/BE[3]#	Command, Byte Enable 3	IDSEL0	Initialization Device Select
27	AD[23]	Address / Data 23	+3.3V	+3.3 V power
28	Ground		AD[22]	Address / Data 22
29	AD[21]	Address / Data 21	AD[20]	Address / Data 20
30	AD[19]	Address / Data 19	Ground	
31	+3.3V	+3.3 V power	AD[18]	Address / Data 18
32	AD[17]	Address / Data 17	AD[16]	Address / Data 16
33	C/BE[2]#	Command, Byte Enable 2	+3.3V	+3.3 V power
34	Ground		FRAME#	Address or Data phase
35	IRDY#	Initiator Ready	Ground	
36	+3.3V	+3.3 V power	TRDY#	Target Ready
37	DEVSEL#	Device Select	Ground	
38	Ground		STOP#	Stop Transfer Cycle
39	LOCK#	Lock bus	+3.3V	+3.3 V power
40	PERR#	Parity Error	SMB_CLK	System Management Bus Clock
41	+3.3V	+3.3 V power	SMB_DAT	System Management Bus Data
42	SERR#	System Error	Ground	
43	+3.3V	+3.3 V power	PAR	Parity
44	C/BE[1]#	Command, Byte Enable 1	AD[15]	Address / Data 15
45	AD[14]	Address / Data 14	+3.3V	+3.3 V power
46	Ground		AD[13]	Address / Data 13
47	AD[12]	Address / Data 12	AD[11]	Address / Data 11
48	AD[10]	Address / Data 10	Ground	
49	Ground		AD[09]	Address / Data 09
50	Key			
51				
52	AD[08]	Address / Data 08	C/BE[0]#	Command, Byte Enable 0
53	AD[07]	Address / Data 07	+3.3V	+3.3 V power
54	+3.3V	+3.3 V power	AD[06]	Address / Data 06

Pin	Side B		Side A	
	Signal	Description	Signal	Description
55	AD[05]	Address / Data 05	AD[04]	Address / Data 04
56	AD[03]	Address / Data 03	Ground	
57	Ground		AD[02]	Address / Data 02
58	AD[01]	Address / Data 01	AD[00]	Address / Data 00
59	+5V	+5 V power	+5V	+5 V power
60	Reserved		Reserved	
61	+5V	+5 V power	+5V	+5 V power
62	+5V	+5 V power	+5V	+5 V power

7.13. PCI Express x4 Slot (PCIE1 & PCIE2)

The ATX-SKL-S supports two PCI Express x4 via slot PCIE1 and PCIE2. Models with Q170 chipset support x4, x2 and x1 signal while models with H110 chipset support x1 signal only.

The 4-lane (x4) PCI Express (PCIE1 & PCIE2) port can be used for external PCI Express cards inclusive graphics card.

Figure 31: PCI Express x4 Slot PCIE1, PCIE2

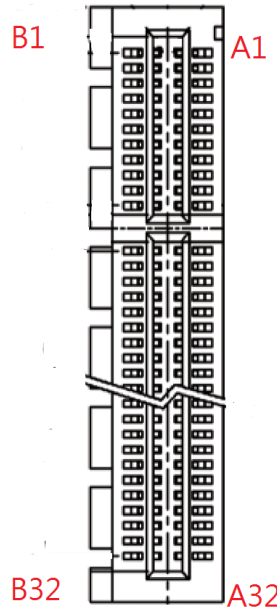

Table 46: Pin Assignment PCIE1, PCIE2

Pin	Side B		Side A	
	Signal	Description	Signal	Description
1	+12V	+12 V power	PRSNT1#	Hot plug presence detect
2	+12V	+12 V power	+12V	+12 V power
3	NC		+12V	+12 V power
4	Ground		Ground	
5	SMB_CLK	SMBus clock	NC	
6	SMB_DAT	SMBus data	NC	
7	Ground		NC	
8	+3.3V	+3.3 V power	NC	
9	NC		+3.3V	+3.3 V power
10	+3.3VSB	+3.3 V standby power	+3.3V	+3.3 V power
11	WAKE#	Link reactivation	RST#	PCI Express reset
12	NC		Ground	
13	Ground		REFCLK+	Reference Clock differential pair
14	PETX0+	Transmitter Lane 0 differential pair	REFCLK-	
15	PETX0-		Ground	
16	Ground		PERX0+	Receiver Lane 0 differential pair

Pin	Side B		Side A	
	Signal	Description	Signal	Description
17	PRSNT2#	Hot plug presence detect	PERX0-	
18	Ground		Ground	
19	PETX1+	Transmitter Lane 1 differential pair	NC	
20	PETX1-		Ground	
21	Ground		PERX1+	Receiver Lane 1 differential pair
22	Ground		PERX1-	
23	PETX2+	Transmitter Lane 2 differential pair	Ground	
24	PETX2-		Ground	
25	Ground		PERX2+	Receiver Lane 2 differential pair
26	Ground		PERX2-	
27	PETX3+	Transmitter Lane 3 differential pair	Ground	
28	PETX3-		Ground	
29	Ground		PERX3+	Receiver Lane 3 differential pair
30	NC		PERX3-	
31	NC		Ground	
32	Ground		NC	

7.14. PCI Express x16 Slot (PEG1)

The ATX-SKL-S supports one PCI Express x16 via slot PEG1.

The 16-lane (x16) PCI Express (PEG1) port can be used for external PCI Express cards inclusive graphics card.

Figure 32: PCI Express x16 Slot PEG1

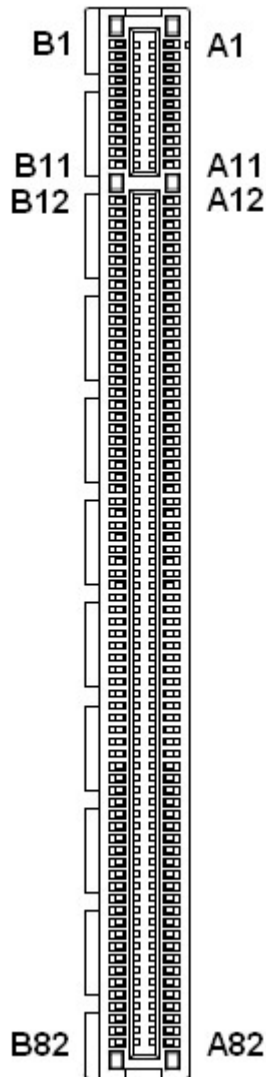

Table 47: Pin Assignment PEG1

Pin	Side B		Side A	
	Signal	Description	Signal	Description
1	+12V	+12 V power	PRSNT1#	Hot plug presence detect
2	+12V	+12 V power	+12V	+12 V power
3	Reserved		+12V	+12 V power
4	Ground		Ground	
5	SMCLK	SMBus clock	Reserved	

Pin	Side B		Side A	
	Signal	Description	Signal	Description
6	SMDAT	SMBus data	Reserved	
7	Ground		Reserved	
8	+3.3V	+3.3 V power	Reserved	
9	Reserved		+3.3V	+3.3 V power
10	+3.3VSB	+3.3 V standby power	+3.3V	+3.3 V power
11	WAKE#	Link reactivation	PERST#	PCI Express reset
12	Reserved		Ground	
13	Ground		REFCLK+	Reference Clock differential pair
14	HSOP0	Transmitter Lane 0 differential pair	REFCLK-	
15	HSO0		Ground	
16	Ground		HSIP0	Receiver Lane 0 differential pair
17	PRSNT2#	Hot plug presence detect	HSIN0	
18	Ground		Ground	
19	HSOP1	Transmitter Lane 1 differential pair	Reserved	
20	HSO1		Ground	
21	Ground		HSIP1	Receiver Lane 1 differential pair
22	Ground		HSIN1	
23	HSOP2	Transmitter Lane 2 differential pair	Ground	
24	HSO2		Ground	
25	Ground		HSIP2	Receiver Lane 2 differential pair
26	Ground		HSIN2	
27	HSOP3	Transmitter Lane 3 differential pair	Ground	
28	HSO3		Ground	
29	Ground		HSIP3	Receiver Lane 3 differential pair
30	Reserved		HSIN3	
31	PRSNT2#	Hot plug presence detect	Ground	
32	Ground		Reserved	
33	HSOP4	Transmitter Lane 4 differential pair	Reserved	
34	HSO4		Ground	
35	Ground		HSIP4	Receiver Lane 4 differential pair
36	Ground		HSIN4	
37	HSOP5	Transmitter Lane 5 differential pair	Ground	
38	HSO5		Ground	
39	Ground		HSIP5	Receiver Lane 5 differential pair
40	Ground		HSIN5	
41	HSOP6	Transmitter Lane 6 differential pair	Ground	
42	HSO6		Ground	
43	Ground		HSIP6	Receiver Lane 6 differential pair
44	Ground		HSIN6	
45	HSOP7	Transmitter Lane 7 differential pair	Ground	
46	HSO7		Ground	

Pin	Side B		Side A	
	Signal	Description	Signal	Description
47	Ground		HSIP7	Receiver Lane 7 differential pair
48	PRSNT2#	Hot plug presence detect	HSIN7	
49	Ground		Ground	
50	HSOP8	Transmitter Lane 8 differential pair	Reserved	
51	HSOP8		Ground	
52	Ground		HSIP8	Receiver Lane 8 differential pair
53	Ground		HSIN8	
54	HSOP9	Transmitter Lane 9 differential pair	Ground	
55	HSOP9		Ground	
56	Ground		HSIP9	Receiver Lane 9 differential pair
57	Ground		HSIN9	
58	HSOP10	Transmitter Lane 10 differential pair	Ground	
59	HSOP10		Ground	
60	Ground		HSIP10	Receiver Lane 10 differential pair
61	Ground		HSIN10	
62	HSOP11	Transmitter Lane 11 differential pair	Ground	
63	HSOP11		Ground	
64	Ground		HSIP11	Receiver Lane 11 differential pair
65	Ground		HSIN11	
66	HSOP12	Transmitter Lane 12 differential pair	Ground	
67	HSOP12		Ground	
68	Ground		HSIP12	Receiver Lane 12 differential pair
69	Ground		HSIN12	
70	HSOP13	Transmitter Lane 13 differential pair	Ground	
71	HSOP13		Ground	
72	Ground		HSIP13	Receiver Lane 13 differential pair
73	Ground		HSIN13	
74	HSOP14	Transmitter Lane 14 differential pair	Ground	
75	HSOP14		Ground	
76	Ground		HSIP14	Receiver Lane 14 differential pair
77	Ground		HSIN14	
78	HSOP15	Transmitter Lane 15 differential pair	Ground	
79	HSOP15		Ground	
80	Ground		HSIP15	Receiver Lane 15 differential pair
81	PRSNT2#	Hot plug presence detect	HSIN15	
82	Reserved		Ground	

7.15. Switches and Jumpers

The product has several jumpers which must be properly configured to ensure correct operation.

Figure 33: Jumper Connector

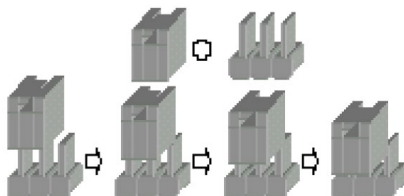

For a three-pin jumper (see Figure 35), the jumper setting is designated "1-2" when the jumper connects pins 1 and 2. The jumper setting is designated "2-3" when pins 2 and 3 are connected and so on. You will see that one of the lines surrounding a jumper pin is thick, which indicates pin No.1.

To move a jumper from one position to another, use needle-nose pliers or tweezers to pull the pin cap off the pins and move it to the desired position.

7.15.1. Pin-9 Selection for COM3 & COM4 (JP1)

Figure 34: Pin-9 Selection JP1

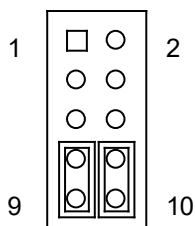

Table 48: Pin Assignment JP1

Jumper 1 Position				Description
Pin 1-3	Pin 3-5	Pin 5-7	Pin 7-9	
X	-	-	-	COM3, Pin 9 = +12V
-	X	-	-	COM3, Pin 9 = +5V
-	-	X	-	COM3, Pin 9 = +5V
-	-	-	X	COM3, Pin 9 = RI
Jumper 2 Position				Description
Pin 2-4	Pin 4-6	Pin 6-8	Pin 8-10	
X	-	-	-	COM4, Pin 9 = +12V
-	X	-	-	COM4, Pin 9 = +5V
-	-	X	-	COM4, Pin 9 = +5V
-	-	-	X	COM4, Pin 9 = RI

"X" = Jumper set (short) and "-" = jumper not set (open)

7.15.2. Keyboard Lock Selection (JP2)

Figure 35: Keyboard Lock Selection JP2

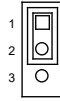

Table 49: Pin Assignment JP2

Jumper 1 Position		Description
Pin 1-2	Pin 2-3	
X	-	Normal
-	X	Keyboard Locked

"X" = Jumper set (short) and "-" = jumper not set (open)

7.15.3. mPCIE LED Indicator Jumper (JP3)

Figure 36: mPCIE LED Indicator Jumper JP3

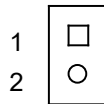

Table 50: Pin Assignment JP3

Pin	Signal	Note
1	LED+	
2	LED-	

7.15.4. Protected RTC Selection (JP4)

Figure 37: Protected RTC Selection JP4

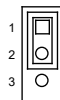

Table 51: Pin Assignment JP4

Jumper 1 Position		Description
Pin 1-2	Pin 2-3	

Jumper 1 Position		Description
Pin 1-2	Pin 2-3	
X	-	Normal (default position)
-	X	Clear RTC_RST Register (board does not boot with the jumper in this position)

"X" = Jumper set (short) and "-" = jumper not set (open)



Do not leave the jumper in position 2-3, otherwise if the power is disconnected, the battery will fully deplete within a few weeks.

7.15.5. mPCIe / mSATA Selection for MPCIE2 & MPCIE1 (JP5 & JP9)

JP5 & JP9 are available only for models with Intel® Q170 chipset.

Figure 38: mPCIe / mSATA Selection JP5, JP9

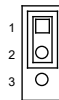

Table 52: Pin Assignment JP5, JP9

Jumper 1 Position		Description
Pin 1-2	Pin 2-3	
X	-	mSATA
-	X	mPCIe

"X" = Jumper set (short) and "-" = jumper not set (open)

7.15.6. ME F/W Selection (JP6)

Figure 39: ME F/W Selection JP6

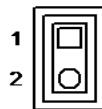

Table 53: Pin Assignment JP6

Jumper Position	Description
Pin 1-2	
X	ME F/W Disabled
-	Normal Operation

"X" = Jumper set (short) and "-" = jumper not set (open)

7.15.7. AT / ATX Power Mode Selection (JP7)

Figure 40: AT / ATX Power Mode Selection JP7



Table 54: Pin Assignment JP7

Jumper 1 Position		Description
Pin 1-2	Pin 2-3	
X	-	ATX Mode
-	X	AT Mode

"X" = Jumper set (short) and "-" = jumper not set (open)

7.15.8. Clear ME Register (JP8)

Figure 41: Clear ME Register JP8



Table 55: Pin Assignment JP8

Jumper 1 Position		Description
Pin 1-2	Pin 2-3	
X	-	Normal
-	X	Clear ME Register

"X" = Jumper set (short) and "-" = jumper not set (open)

7.15.9. PCIe Configuration Setting for PEG1 (JP12)

JP12 is available only for models with Intel® Q170 chipset.

Figure 42: PCIe Configuration Setting JP12

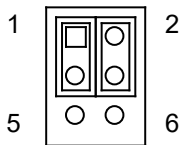

Table 56: Pin Assignment JP12

Jumper 1 Position		Jumper 2 Position		Description
Pin 1-3	Pin 3-5	Pin 2-4	Pin 4-6	
X	-	X	-	X16
X	-	-	X	X8 x8
-	X	X	-	X8 x4
-	X	-	X	X8 x4 x4

"X" = Jumper set (short) and "-" = jumper not set (open)

7.15.10. Terminator Selection for COM1 & COM2 (JP13 & JP14)

Figure 43: COM Terminator Selection JP13, JP14

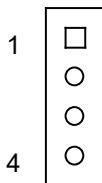

Table 57: Pin Assignment JP13, JP14

Jumper 1 Position	Description
Pin 1-2	
X	Terminator is enabled between RX+ & RX-
-	Terminator is disabled
Jumper 2 Position	Description
Pin 3-4	
X	Terminator is enabled between TX+ & TX-
-	Terminator is disabled

"X" = Jumper set (short) and "-" = jumper not set (open)

7.15.11. Pin-9 Selection for COM1 & COM2 (JP15)

Figure 44: Pin-9 Selection JP15

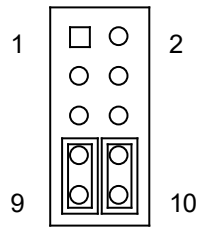

Table 58: Pin Assignment JP15

Jumper 1 Position				Description
Pin 1-3	Pin 3-5	Pin 5-7	Pin 7-9	
X	-	-	-	COM1, Pin 9 = +12V
-	X	-	-	COM1, Pin 9 = +5V
-	-	X	-	COM1, Pin 9 = +5V
-	-	-	X	COM1, Pin 9 = RI
Jumper 2 Position				Description
Pin 2-4	Pin 4-6	Pin 6-8	Pin 8-10	
X	-	-	-	COM2, Pin 9 = +12V
-	X	-	-	COM2, Pin 9 = +5V
-	-	X	-	COM2, Pin 9 = +5V
-	-	-	X	COM2, Pin 9 = RI

"X" = Jumper set (short) and "-" = jumper not set (open)

8/ BIOS

8.1. Starting the uEFI BIOS

The ATX-SKL-S is provided with a Kontron-customized, pre-installed and configured version of AMI Aptio® V uEFI BIOS. AMI BIOS firmware is based on the Unified Extensible Firmware Interface (UEFI) specification and the Intel® Platform Innovation Framework for EFI. This uEFI BIOS provides a variety of new and enhanced functions specifically tailored to the hardware features of the ATX-SKL-S.

The uEFI BIOS comes with a setup program that provides quick and easy access to the individual function settings for control or modification of the uEFI BIOS configuration. The setup program allows the accessing of various menus that provide functions or access to sub-menus with more specific functions of their own.

To start the uEFI BIOS setup program, follow the steps below:

1. Power on the board.
2. Wait until the first characters appear on the screen (POST messages or splash screen).
3. Press the key.
4. If the uEFI BIOS is password-protected, a request for password will appear. Enter either the User Password or the Supervisor Password (see Security menu), press <RETURN>, and proceed with step 5.
5. A setup menu will appear.

The ATX-SKL-S uEFI BIOS setup program uses a hot key-based navigation system. A hot key legend bar is located on the bottom of the setup screens.

The following table provides information concerning the usage of these hot keys.

Table 59: Font Size Table

Hotkeys	Description
<F1>	The <F1> key invokes the General Help window.
<->	The <Minus> key selects the next lower value within a field.
<+>	The <Plus> key selects the next higher value within a field.
<F2>	The <F2> key loads the previous values.
<F3>	The <F3> key loads the standard default values.
<F4>	The <F4> key saves the current settings and exit the uEFI BIOS setup.
<→> or <←>	The <Left/Right> arrows selects major setup menus on the menu bar. For example: Main, Advanced, Security, etc.
<↑> or <↓>	The <Up/Down> arrows selects fields in the current menu. For example: A setup function or a sub-screen.
<ESC>	The <ESC> key exits a major setup menu and enter the Exit setup menu. Pressing the <ESC> key in a sub-menu displays the next higher menu level.
<RERURN>	The <RETURN> key executes a command or select a submenu.

8.2. Setup Menus

The Setup utility features shows six menus in the selection bar at the top of the screen:

- ▶ Main
- ▶ Advanced
- ▶ Power
- ▶ Security
- ▶ Boot
- ▶ Save & Exit

The Setup menus are selected via the left and right arrow keys. The currently active menu and the currently active uEFI BIOS Setup item are highlighted in white. Each Setup menu provides two main frames. The left frame displays all available functions. Functions that can be configured are displayed in blue. Functions displayed in gray provide information about the status or the operational configuration. The right frame displays an Item Specific Help window providing an explanation of the respective function.

8.2.1. Main Setup Menu

Upon entering the uEFI BIOS Setup program, the Main Setup menu is displayed. This screen lists the Main Setup menu sub-screens and provides basic system information. Additionally functions for setting the system time and date are offered.

Table 60: Main Setup Menu Sub-Screens and Functions

Function	Description
BIOS Information	Read only field. Displays information about the system BIOS
Memory Information	Read only field. Displays information about total memory
ME Information	Read only field. Displays information about Intel Management Engine (ME) version
TXE Information	Read only field. Displays information about TXE information
Firmware Information	Code version and firmware information
System Date	Set System Date
System Time	Set System Time

Figure 45: BIOS Main Menu Screen System Data and Time

BIOS SETUP UTILITY					
Main	Advanced	Power	Security	Boot	Save & Exit
Product Information					
Product Name		ATX-SKL-S-Q170			
BIOS Version		R1.06 (x64)			
BIOS Build Date		01/15/2016			
ME FW Version		11.0.0.1178			
CPU Information					
Intel® Core™ i7-6700TE CPU@ 2.40GHz					
Microcode Revision		39			
Processor Cores		4		→ ←: Select Screen	
Memory Information					
Total Size		4096 MB		↑ ↓: Select Item	
Frequency		2133 MHz		Enter: Select	
System Date		[Mon 01/25/2016]		+/-: Change Opt.	
System Time		[13:48:23]		F1: General Help	
Access Level		Administrator		F2: Previous Values	
				F3: Optimized Defaults	
				F4: Save & Exit	
				ESC: Exit	
Version 2.17.1254. Copyright (C) 2016, American Megatrends, Inc.					

Feature	Option	Description
System Date	[dd/mm/yyyy]	Set the Date. Use Tab to switch between Data elements.
System Time	[hh:mm:ss]	Set the Time. Use Tab to switch between Time elements.

8.2.2. Advanced Setup Menu

The Advanced setup menu provides sub-screens and functions for advanced configurations. The following sub-screen functions are included in the menu:

- ▶ LAN & Audio Configuration
- ▶ Display Configuration
- ▶ Super IO Configuration
- ▶ CPU Chipset Configuration
- ▶ SATA Configuration
- ▶ USB Configuration
- ▶ AMT Configuration
- ▶ TPM Configuration
- ▶ DIO Configuration
- ▶ H/W Monitor

NOTICE

Setting items on this screen to incorrect values may cause the system to malfunction.

Figure 46: BIOS Advanced Menu

BIOS SETUP UTILITY					
Main	Advanced	Power	Security	Boot	Save & Exit
Onboard LAN1 Controller		[Enabled]			
Onboard LAN1 Boot		[Disabled]			
Onboard LAN2 Controller		[Enabled]			
Onboard LAN2 Boot		[Disabled]			
Audio Controller		[Enabled]			
> Display Configuration				→ ←: Select Screen	
> Super IO Configuration				↑ ↓: Select Item	
> CPU Chipset Configuration				Enter: Select	
> SATA Configuration				+/-: Change Opt.	
> USB Configuration				F1: General Help	
> AMT Configuration				F2: Previous Values	
> TPM Configuration				F3: Optimized Defaults	
> DIO Configuration				F4: Save & Exit	
> H/W Monitor				ESC: Exit	
Version 2.17.1254. Copyright (C) 2016, American Megatrends, Inc.					

Feature	Option	Description
Onboard LAN1 Controller	[Disabled], [Enabled]	Select whether to enable or disable Onboard LAN1 Controller.
Onboard LAN1 Boot	[Disabled], [Enabled]	Select whether to enable or disable load onboard PXE (Preboot Execution Environment).
Onboard LAN2 Controller	[Disabled], [Enabled]	Select whether to enable or disable Onboard LAN2 Controller.
Onboard LAN2 Boot	[Disabled], [Enabled]	Select whether to enable or disable load onboard PXE (Preboot Execution Environment).
Audio Controller	[Disabled], [Enabled]	Select whether to enable or disable Audio Controller.

Figure 47: BIOS Advanced Menu - Display Configuration

BIOS SETUP UTILITY					
Main	Advanced	Power	Security	Boot	Save & Exit
Display Configuration					
Primary Display		[Auto]		→ ←: Select Screen	
UWA Frame Buffer Size		[256MB]		↑ ↓: Select Item	
DVMT Pre-Allocated		[64M]		Enter: Select	
DVMT Total Gfx Mem		[256M]		+/-: Change Opt.	
Primary IGFX Boot Display		[VBIOS Default]		F1: General Help	
				F2: Previous Values	
				F3: Optimized Defaults	
				F4: Save & Exit	
				ESC: Exit	
Version 2.17.1254. Copyright (C) 2016, American Megatrends, Inc.					

Feature	Option	Description
Primary Display	[Auto], [IGFX], [PEG], [PCIE]	Select which graphic controller to be used as the primary display device.
UWA Frame Buffer Size	[128MB], [256MB], [512MB]	Select the Aperture Size.
DVMT Pre-Allocated	[32M], [64M], [96M], [128M], [160M], [192M], [224M], [256M], [288M], [320M], [352M], [384M], [416M], [448M], [480M], [512M], [1024M]	Select DVMT Pre-Allocated (Fixed) Graphics Memory size used by the Internal Graphics Device.
DVMT Total Gfx Mem	[128M], [256M], [MAX]	Select DVMT Total Graphic Memory size used by the Internal Graphics Device.
Primary IGFX Boot Display	[VBIOS Default], [CRT], [DP], [DVI], [HDMI]	Select the Video Device which will be activated during POST. This has no effect if external graphics present. Secondary boot display selection will appear based on your selection. DOS modes will be supported only on primary display.

Figure 48: BIOS Advanced Menu - Super IO Configuration

BIOS SETUP UTILITY					
Main	Advanced	Power	Security	Boot	Save & Exit
Super IO Chip Configuration					
> Serial Port 1 Configuration > Serial Port 2 Configuration > Serial Port 3 Configuration > Serial Port 4 Configuration > Serial Port 5 Configuration > Serial Port 6 Configuration				→ ←: Select Screen ↑ ↓: Select Item Enter: Select +/-: Change Opt. F1: General Help F2: Previous Values F3: Optimized Defaults F4: Save & Exit ESC: Exit	
Version 2.17.1254. Copyright (C) 2016, American Megatrends, Inc.					

Figure 49: BIOS Advanced Menu - Super IO Configuration - Serial Port 1 Configuration

BIOS SETUP UTILITY					
Main	Advanced	Power	Security	Boot	Save & Exit
Serial Port 1 Configuration					
Serial Port		[Enabled]		→ ←: Select Screen ↑ ↓: Select Item Enter: Select +/-: Change Opt. F1: General Help F2: Previous Values F3: Optimized Defaults F4: Save & Exit ESC: Exit	
Device Settings		IO=3F8h; IRQ=4;			
Change Setting		[Auto]			
Serial Port 1 Type		[RS232]			
RS485 Deplx Mode*		[Half Duplex]			
RS485 Auto Flow Control*		[Disabled]			
Version 2.17.1254. Copyright (C) 2016, American Megatrends, Inc.					

* These items appear only when selecting RS485 for the Serial Port 1 Type.

Feature	Option	Description
Serial Port	[Disabled], [Enabled]	Select whether to enable or disable Serial Port (COM).
Change Settings	[Auto], [IO=3F8h; IRQ=4;], [IO=3F8h; IRQ=3, 4, 5, 6, 7, 9, 10, 11, 12;], [IO=2F8h; IRQ=3, 4, 5, 6, 7, 9, 10, 11, 12;], [IO=3E8h; IRQ=3, 4, 5, 6, 7, 9, 10, 11, 12;], [IO=2E8h; IRQ=3, 4, 5, 6, 7, 9, 10, 11, 12;]	Select an optional setting for Super IO device.

Feature	Option	Description
Serial Port 1 Type	[RS232], [RS422], [RS485]	Select an appropriate type for Serial Port 1.
RS485 Duplex Mode	[Half Duplex], [Full Duplex]	Select an appropriate RS485 Duplex Mode.
RS485 Auto Flow Control	[Disabled], [Enabled]	Select whether to enable or disable RS485 Auto Flow Control.

Figure 50: BIOS Advanced Menu - Super IO Configuration - Serial Port 2 Configuration

BIOS SETUP UTILITY					
Main	Advanced	Power	Security	Boot	Save & Exit
Serial Port 2 Configuration					
Serial Port		[Enabled]		→ ←: Select Screen	
Device Settings		IO=2F8h; IRQ=3;		↑ ↓: Select Item	
Change Setting		[Auto]		Enter: Select	
Serial Port 2 Type		[RS232]		+/-: Change Opt.	
RS485 Deplx Mode*		[Half Duplex]		F1: General Help	
RS485 Auto Flow Control*		[Disabled]		F2: Previous Values	
				F3: Optimized Defaults	
				F4: Save & Exit	
				ESC: Exit	
Version 2.17.1254. Copyright (C) 2016, American Megatrends, Inc.					

* These items appear only when selecting RS485 for the Serial Port 2 Type.

Feature	Option	Description
Serial Port	[Disabled], [Enabled]	Select whether to enable or disable Serial Port (COM).
Change Settings	[Auto], [IO=2F8h; IRQ=3;], [IO=3F8h; IRQ=3, 4, 5, 6, 7, 9, 10, 11, 12;], [IO=2F8h; IRQ=3, 4, 5, 6, 7, 9, 10, 11, 12;], [IO=3E8h; IRQ=3, 4, 5, 6, 7, 9, 10, 11, 12;], [IO=2E8h; IRQ=3, 4, 5, 6, 7, 9, 10, 11, 12;]	Select an optional setting for Super IO device.
Serial Port 2 Type	[RS232], [RS422], [RS485]	Select an appropriate type for Serial Port 2.
RS485 Duplex Mode	[Half Duplex], [Full Duplex]	Select an appropriate RS485 Duplex Mode.
RS485 Auto Flow Control	[Disabled], [Enabled]	Select whether to enable or disable RS485 Auto Flow Control.

Figure 51: BIOS Advanced Menu - Super IO Configuration - Serial Port 3 Configuration

BIOS SETUP UTILITY					
Main	Advanced	Power	Security	Boot	Save & Exit
Serial Port 3 Configuration					
Serial Port		[Enabled]		→ ←: Select Screen ↑ ↓: Select Item Enter: Select +/-: Change Opt. F1: General Help F2: Previous Values F3: Optimized Defaults F4: Save & Exit ESC: Exit	
Device Settings		IO=3E8h; IRQ=7;			
Change Setting		[Auto]			
Version 2.17.1254. Copyright (C) 2016, American Megatrends, Inc.					

Feature	Option	Description
Serial Port	[Disabled], [Enabled]	Select whether to enable or disable Serial Port (COM).
Change Settings	[Auto], [IO=3E8h; IRQ=7;], [IO=3E8h; IRQ=3, 4, 5, 6, 7, 9, 10, 11, 12;], [IO=2E8h; IRQ=3, 4, 5, 6, 7, 9, 10, 11, 12;], [IO=2F0h; IRQ=3, 4, 5, 6, 7, 9, 10, 11, 12;], [IO=2E0h; IRQ=3, 4, 5, 6, 7, 9, 10, 11, 12;]	Select an optional setting for Super IO device.

Figure 52: BIOS Advanced Menu - Super IO Configuration - Serial Port 4 Configuration

BIOS SETUP UTILITY					
Main	Advanced	Power	Security	Boot	Save & Exit
Serial Port 4 Configuration					
Serial Port		[Enabled]		→ ←: Select Screen ↑ ↓: Select Item Enter: Select +/-: Change Opt. F1: General Help F2: Previous Values F3: Optimized Defaults F4: Save & Exit ESC: Exit	
Device Settings		IO=2E8h; IRQ=7;			
Change Setting		[Auto]			
Version 2.17.1254. Copyright (C) 2016, American Megatrends, Inc.					

Feature	Option	Description
Serial Port	[Disabled], [Enabled]	Select whether to enable or disable Serial Port (COM).
Change Settings	[Auto], [IO=2E8h; IRQ=7;], [IO=3E8h; IRQ=3, 4, 5, 6, 7, 9, 10, 11, 12;], [IO=2E8h; IRQ=3, 4, 5, 6, 7, 9, 10, 11, 12;], [IO=2F0h; IRQ=3, 4, 5, 6, 7, 9, 10, 11, 12;], [IO=2E0h; IRQ=3, 4, 5, 6, 7, 9, 10, 11, 12;]	Select an optional setting for Super IO device.

Figure 53: BIOS Advanced Menu - Super IO Configuration - Serial Port 5 Configuration

BIOS SETUP UTILITY					
Main	Advanced	Power	Security	Boot	Save & Exit
Serial Port 5 Configuration					
Serial Port		[Enabled]		→ ←: Select Screen	
Device Settings		IO=2F0h; IRQ=7;		↑ ↓: Select Item	
Change Setting		[Auto]		Enter: Select	
				+/-: Change Opt.	
				F1: General Help	
				F2: Previous Values	
				F3: Optimized Defaults	
				F4: Save & Exit	
				ESC: Exit	
Version 2.17.1254. Copyright (C) 2016, American Megatrends, Inc.					

Feature	Option	Description
Serial Port	[Disabled], [Enabled]	Select whether to enable or disable Serial Port (COM).
Change Settings	[Auto], [IO=2F0h; IRQ=7;], [IO=3E8h; IRQ=3, 4, 5, 6, 7, 9, 10, 11, 12;], [IO=2E8h; IRQ=3, 4, 5, 6, 7, 9, 10, 11, 12;], [IO=2F0h; IRQ=3, 4, 5, 6, 7, 9, 10, 11, 12;], [IO=2E0h; IRQ=3, 4, 5, 6, 7, 9, 10, 11, 12;]	Select an optional setting for Super IO device.

Figure 54: BIOS Advanced Menu - Super IO Configuration - Serial Port 6 Configuration

BIOS SETUP UTILITY					
Main	Advanced	Power	Security	Boot	Save & Exit
Serial Port 6 Configuration					
Serial Port		[Enabled]		→ ←: Select Screen ↑ ↓: Select Item Enter: Select +/-: Change Opt. F1: General Help F2: Previous Values F3: Optimized Defaults F4: Save & Exit ESC: Exit	
Device Settings		IO=2E0h; IRQ=7;			
Change Setting		[Auto]			
Version 2.17.1254. Copyright (C) 2016, American Megatrends, Inc.					

Feature	Option	Description
Serial Port	[Disabled], [Enabled]	Select whether to enable or disable Serial Port (COM).
Change Settings	[Auto], [IO=2E0h; IRQ=7;], [IO=3E8h; IRQ=3, 4, 5, 6, 7, 9, 10, 11, 12;], [IO=2E8h; IRQ=3, 4, 5, 6, 7, 9, 10, 11, 12;], [IO=2F0h; IRQ=3, 4, 5, 6, 7, 9, 10, 11, 12;], [IO=2E0h; IRQ=3, 4, 5, 6, 7, 9, 10, 11, 12;]	Select an optional setting for Super IO device.

Figure 55: BIOS Advanced Menu - CPU Chipset Configuration

BIOS SETUP UTILITY					
Main	Advanced	Power	Security	Boot	Save & Exit
CPU Chipset Configuration					
EIST		[Enabled]		→ ←: Select Screen	
Turbo Mode		[Enabled]		↑ ↓: Select Item	
Hyper-threading		[Enabled]		Enter: Select	
VT-d		[Enabled]		+/-: Change Opt.	
Active Processor Cores		[All]		F1: General Help	
Limit CPUID Maximum		[Disabled]		F2: Previous Values	
Execute Disable Bit		[Enabled]		F3: Optimized Defaults	
Intel® Virtualization Technology		[Disabled]		F4: Save & Exit	
Intel® TXT(LT) Support		[Disabled]		ESC: Exit	
Version 2.17.1254. Copyright (C) 2016, American Megatrends, Inc.					

Feature	Option	Description
EIST	[Disabled], [Enabled]	Select whether to enable or disable Enhanced Intel SpeedStep Technology.
Turbo Mode	[Disabled], [Enabled]	Select whether to enable or disable turbo mode.
Hyper-threading	[Disabled], [Enabled]	Select whether to enable or disable Hyper-threading technology. [Enabled] for Windows XP and Linux (OS optimized for Hyper-Threading Technology). [Disabled] for other OS (OS not optimized for Hyper-Threading Technology).
VT-d	[Disabled], [Enabled]	Select whether to enable or disable VT-d capability.
Active Processor Cores	[All], [1], [2], [3]	Select the number of cores to enable in each processor package.
Limit CPUID Maximum	[Disabled], [Enabled]	Select whether to limit CPUID maximum value.
Execute Disable Bit	[Disabled], [Enabled]	Select whether to enable or disable Execute Disable Bit functionality, which prevents malicious buffer overflow attacks..
Intel® Virtualization Technology	[Disabled], [Enabled]	Select whether to enable or disable Intel Virtualization Technology.
Intel® TXT(LT) Support	[Disabled], [Enabled]	Select whether to enable or disable Intel TXT(LT) support.

Figure 56: BIOS Advanced Menu - SATA Configuration

BIOS SETUP UTILITY					
Main	Advanced	Power	Security	Boot	Save & Exit
SATA Controller(s)					
SATA Controller(s)		[Enabled]			
SATA Mode Selection		[AHCI Mode]			
Serial ATA Port 1		Empty			
Port 1		[Enabled]			
Serial ATA Port 2		Empty			
Port 2		[Enabled]		→ ←: Select Screen ↑ ↓: Select Item Enter: Select +/-: Change Opt. F1: General Help F2: Previous Values F3: Optimized Defaults F4: Save & Exit ESC: Exit	
Serial ATA Port 3		Empty			
Port 3		[Enabled]			
Serial ATA Port 4		Empty			
Port 4		[Enabled]			
mS ATA Port 1		Empty			
Port 1		[Enabled]			
mSATA Port 2		Empty			
Port 2		[Enabled]			
Version 2.17.1254. Copyright (C) 2016, American Megatrends, Inc.					

Feature	Option	Description
SATA Controller(s)	[Enabled], [Disabled]	Select whether to enable or disable SATA Device.
SATA Mode Selection	[AHCI], [RAID]	Determine how SATA controller(s) operate.
Port 1 / 2 / 3 / 4	[Disabled], [Enabled]	Select whether to enable or disable SATA Port 1 / 2 / 3 / 4 or mSATA Port 1 / 2.

Figure 57: BIOS Advanced Menu - USB Configuration

BIOS SETUP UTILITY					
Main	Advanced	Power	Security	Boot	Save & Exit
USB Configuration					
USB Devices: None				→ ←: Select Screen ↑ ↓: Select Item Enter: Select	
Legacy USB Support		[Enabled]		+/-: Change Opt.	
XHCI Hand-off		[Disabled]		F1: General Help	
USB Mass Storage Driver Support		[Enabled]		F2: Previous Values	
				F3: Optimized Defaults	
				F4: Save & Exit	
				ESC: Exit	
Version 2.17.1254. Copyright (C) 2016, American Megatrends, Inc.					

Feature	Option	Description
Legacy USB Support	[Enabled], [Disabled]	Select whether to enable or disable Legacy USB support. AUTO option disables legacy support if no USB devices are connected.
XHCI Hand-off	[Enabled], [Disabled]	Select whether to enable or disable XHCI Hand-off function. This is a workaround for OSeS without XHCI hand-off support. The XHCI ownership change should be claimed by XHCI driver.
USB Mass Storage Driver Support	[Disabled], [Enabled]	Select whether to enable or disable USB Mass Storage Driver Support.

Figure 58: BIOS Advanced Menu - AMT Configuration*

BIOS SETUP UTILITY					
Main	Advanced	Power	Security	Boot	Save & Exit
AMT Configuration					
Intel AMT		[Enabled]		→ ←: Select Screen	
Un-Configure ME		[Disabled]		↑ ↓: Select Item	
				Enter: Select	
				+/-: Change Opt.	
				F1: General Help	
				F2: Previous Values	
				F3: Optimized Defaults	
				F4: Save & Exit	
				ESC: Exit	
Version 2.17.1254. Copyright (C) 2016, American Megatrends, Inc.					

* This configuration is available only for models with Intel® Q170 chipset.

Feature	Option	Description
Intel AMT	[Disabled], [Enabled]	Select whether to enable or disable Intel AMT (Active Management Technology).
Un-Configure ME	[Disabled], [Enabled]	Select whether to enable or disable Un-Configure ME without password.

Figure 59: BIOS Advanced Menu - TPM Configuration*

BIOS SETUP UTILITY					
Main	Advanced	Power	Security	Boot	Save & Exit
TPM Configuration					
Security Device Support		[Disabled]			
Current Status Information				→ ←: Select Screen ↑ ↓: Select Item Enter: Select +/-: Change Opt. F1: General Help F2: Previous Values F3: Optimized Defaults F4: Save & Exit ESC: Exit	
Version 2.17.1254. Copyright (C) 2016, American Megatrends, Inc.					

* This configuration is available only for models with Intel® Q170 chipset.

Feature	Option	Description
Security Device Support	[Disabled], [Enabled]	Select whether to enable or disable security device support.

Figure 60: BIOS Advanced Menu - DIO Configuration

BIOS SETUP UTILITY					
Main	Advanced	Power	Security	Boot	Save & Exit
DIO Configuration					
User Configuration		[Disabled]			
DIO_0*		[Output High]			
DIO_1*		[Output High]			
DIO_2*		[Output High]			
DIO_3*		[Output High]			
DIO_4*		[Output High]			
DIO_5*		[Output High]			
DIO_6*		[Output High]			
DIO_7*		[Output High]			
DIO_8*		[Output High]			
DIO_9*		[Output High]			
DIO_10*		[Output High]			
DIO_11*		[Output High]			
DIO_12*		[Output High]			
DIO_13*		[Output High]			
DIO_14*		[Output High]			
DIO_15*		[Output High]			
DIO_0 Value		1			
DIO_1 Value		1			
DIO_2 Value		1			
DIO_3 Value		1			
DIO_4 Value		1			
DIO_5 Value		1			
DIO_6 Value		1			
DIO_7 Value		1			
DIO_8 Value		1			
DIO_9 Value		1			
DIO_10 Value		1			
DIO_11 Value		1			
DIO_12 Value		1			
DIO_13 Value		1			
DIO_14 Value		1			
DIO_15 Value		1			
				→ ←: Select Screen ↑ ↓: Select Item Enter: Select +/-: Change Opt. F1: General Help F2: Previous Values F3: Optimized Defaults F4: Save & Exit ESC: Exit	
Version 2.17.1254. Copyright (C) 2016, American Megatrends, Inc.					

* These items appear only when enabling "User Configuration".

Feature	Option	Description
User Configuration	[Enabled], [Disabled]	Select whether or not to allow user to set the DO pin output value.
DIO_0..15	[Output Low], [Output High], [Input]	Set up the DIO pin input / output value.

Figure 61: BIOS Advanced Menu - H/W Monitor

BIOS SETUP UTILITY					
Main	Advanced	Power	Security	Boot	Save & Exit
PC Health Status					
CPU Warning Temperature		[Disabled]			
> Smart FAN Configuration					
CPU Temperature		: +19 C			
System Temperature		: +22 C			
CPU Fan Speed		: 4326 RPM			
SYS Fan Speed		: N/A			
AUX Fan Speed		: N/A			
+V CORE		: +0.997 V		→ ←: Select Screen ↑ ↓: Select Item Enter: Select +/-: Change Opt. F1: General Help F2: Previous Values F3: Optimized Defaults F4: Save & Exit ESC: Exit	
+12V		: +12.164 V			
+5V		: +4.986 V			
+VMEN		: +1.221 V			
+3.3VSB		: +3.296 V			
+3.3V		: +3.376 V			
+VRTC		: +3.280 V			
+1.05V		: +1.080 V			
Version 2.17.1254. Copyright (C) 2016, American Megatrends, Inc.					

Feature	Option	Description
CPU Warning Temperature	[Disabled], [80], [85], [90], [95]	Determine whether to enable or disable CPU Warning Temperature function and select a temperature that will sound an alarm.

BIOS SETUP UTILITY					
Main	Advanced	Power	Security	Boot	Save & Exit
Smart FAN Configuration					
CPU FAN Setting		[Manual]		→ ←: Select Screen ↑ ↓: Select Item Enter: Select +/-: Change Opt. F1: General Help F2: Previous Values F3: Optimized Defaults F4: Save & Exit ESC: Exit	
Manual Duty		255			
SYS FAN Setting		[Manual]			
Manual Duty		255			
AUX FAN Setting		[Manual]			
Manual Duty		255			

BIOS SETUP UTILITY					
Main	Advanced	Power	Security	Boot	Save & Exit
Version 2.17.1254. Copyright (C) 2016, American Megatrends, Inc.					

Feature	Option	Description
CPU FAN Setting	[Manual], [Smart]	Switch the CPU FAN control mode.
SYS FAN Setting	[Manual], [Smart]	Switch the SYS FAN control mode.
AUX FAN Setting	[Manual], [Smart]	Switch the AUX FAN control mode.

8.2.3. Power Setup Menu

The Power setup menu provides functions and a sub-screen for power configurations. The following sub-screen function is included in the menu:

- ▶ WatchDog Timer Configuration

Figure 62: BIOS Power Setup Menu

BIOS SETUP UTILITY					
Main	Advanced	Power	Security	Boot	Save & Exit
Power Management Configuration					
ACPI Sleep State		[S3 (Suspend to RAM)]			
Restore AC Power Loss		[Power Off]			
Power Saving Mode		[Disabled]			
Resume Event Control				→ ←: Select Screen	
Resume From S3 By PS/2 Keyboard		[Disabled]		↑ ↓: Select Item	
Resume From S3 By PS/2 Mouse		[Disabled]		Enter: Select	
Resume By LAN Device		[Disabled]		+/-: Change Opt.	
Resume By PCI Device (PME#)		[Disabled]		F1: General Help	
Resume By PCI-E Device		[Disabled]		F2: Previous Values	
Resume By Ring Device		[Disabled]		F3: Optimized Defaults	
Resume By RTC Alarm		[Disabled]		F4: Save & Exit	
> WatchDog Timer Configuration				ESC: Exit	
Version 2.17.1254. Copyright (C) 2016, American Megatrends, Inc.					

Feature	Option	Description
ACPI Sleep State	[Suspend Disabled], [S3 (Suspend to RAM)]	Select whether to enable or disable suspend function and determine an appropriate suspend mode.
Restore AC Power Loss	[Power Off], [Power On], [Last State]	Control whether the system will stay on after AC power is removed and then restored. Select [Power Off] if you want the system to remain off after power restored. Select [Power On] if you use a power strip to turn the system on.
Power Saving Mode	[Disabled], [EUP Enabled], [DeepSx Enabled]	Select whether to enable Power Saving Mode.
Resume From S3 By PS/2 Keyboard	[Disabled], [Enabled]	Select whether to allow waking the system up from the S3 sleep state by PS/2 keyboard.
Resume From S3 By PS/2 Mouse	[Disabled], [Enabled]	Select whether to allow waking the system up from the S3 sleep state by PS/2 mouse.
Resume By LAN Device	[Disabled], [Enabled]	Select whether to enable or disable Wake from LAN Device.
Resume By PCI Device (PME#)	[Disabled], [Enabled]	Select whether to enable or disable Wake from PCI Device (PME#).
Resume By PCI-E	[Disabled], [Enabled]	Select whether to enable or disable Wake from PCI-E Device.

Feature	Option	Description
Device		
Resume By Ring Device	[Disabled], [Enabled]	Select whether to enable or disable Wake from Ring Device.
Resume By RTC Alarm	[Disabled], [Enabled]	Select whether to enable or disable Wake Up on Alarm, to turn on your system on a special day of the month.

Figure 63: BIOS Power Setup Menu - WatchDog Timer Configuration

BIOS SETUP UTILITY					
Main	Advanced	Power	Security	Boot	Save & Exit
WatchDog Timer Configuration					
WDT Function		[Disabled]		→ ←: Select Screen ↑ ↓: Select Item Enter: Select +/-: Change Opt. F1: General Help F2: Previous Values F3: Optimized Defaults F4: Save & Exit ESC: Exit	
Version 2.17.1254. Copyright (C) 2016, American Megatrends, Inc.					

Feature	Option	Description
WDT Function	[Disabled], [Enabled]	Select whether to enable or disable WatchDog Timer function.

8.2.4. Security Setup Menu

The Security setup menu provides information about the passwords and functions for specifying the security settings. The passwords are case-sensitive. The ATX-SKL-S provides no factory-set passwords.

NOTICE

If there is already a password installed, the system asks for this first. To clear a password, simply enter nothing and acknowledge by pressing <RETURN>. To set a password, enter it twice and acknowledge by pressing <RETURN>.

Figure 64: BIOS Boot Setup Menu

BIOS SETUP UTILITY					
Main	Advanced	Power	Security	Boot	Save & Exit
Password Description If ONLY the Administrator's password is set, then this only limits access to Setup and is only asked for when entering Setup If ONLY the User's password is set, then this is a power on password and must be entered to boot or enter Setup. In Setup the User will have Administrator rights The password length must be in the following range:					
Minimum Length		3		→ ←: Select Screen	
Maximum length		20		↑ ↓: Select Item	
Administrator Password				Enter: Select	
User Password				+/-: Change Opt.	
				F1: General Help	
				F2: Previous Values	
				F3: Optimized Defaults	
				F4: Save & Exit	
				ESC: Exit	
Version 2.17.1254. Copyright (C) 2016, American Megatrends, Inc.					

Feature	Description
Administrator Password	Set administrator password
User Password	Set user password



If only the administrator's password is set, then only access to setup is limited. The password is only entered when entering setup.

If only the user's password is set, then the password is a power on password and must be entered to boot or enter setup. Within the setup menu the user has administrator rights.

Password length requirements are maximum 20 characters and minimum 3 characters.

8.2.4.1. Remember the password

It is highly recommended to keep a record of all passwords in a safe place. Forgotten passwords results in being locked out of the system.

If the system cannot be booted because the User Password or the Supervisor Password are not know, contact Kontron Support for further assistance.



HDD security passwords cannot be cleared using the above method.

8.2.5. Boot Setup Menu

The boot setup menu lists the for boot device priority order, that is generated dynamically.

Figure 65: BIOS Boot Setup Menu

BIOS SETUP UTILITY					
Main	Advanced	Power	Security	Boot	Save & Exit
Boot Configuration					
Full Screen LOGO Display		[Disabled]			
Setup Prompt Timeout		1		→ ←: Select Screen	
Bootup NumLock State		[On]		↑ ↓: Select Item	
CSM Support		[Enabled]		Enter: Select	
Boot Option Filter		[Legacy Only]		+/-: Change Opt.	
Boot Option Priorities				F1: General Help	
				F2: Previous Values	
				F3: Optimized Defaults	
				F4: Save & Exit	
				ESC: Exit	
Version 2.17.1254. Copyright (C) 2016, American Megatrends, Inc.					

Feature	Option	Description
Full Screen LOGO Display	[Disabled], [Enabled]	Select whether to enable or disable to display logo screen.
Bootup NumLock State	[On], [Off]	Select the state of the NumLock feature of the keyboard after Startup. [On]: The keys on the keypad will act as numeric keys. [Off]: The keys on the keypad will act as cursor keys.
CSM Support	[Enabled], [Disabled]	Select whether to enable or disable CSM support.
Boot Option Filter	[UEFI and Legacy], [Legacy only], [UEFI only]	Control Legacy / UEFI ROMs priority.

8.2.6. Save & Exit Setup Menu

The exit setup menu provides functions for handling changes made to the UEFI BIOS settings and the exiting of the setup program.

Figure 66: BIOS Boot Setup Menu

BIOS SETUP UTILITY					
Main	Advanced	Power	Security	Boot	Save & Exit
Save Changes and Reset					
Discard Changes and Reset					
Save Options				→ ←: Select Screen	
Save Changes				↑ ↓: Select Item	
Discard Changes				Enter: Select	
Restore Defaults				+/-: Change Opt.	
				F1: General Help	
				F2: Previous Values	
				F3: Optimized Defaults	
				F4: Save & Exit	
				ESC: Exit	
Version 2.17.1254. Copyright (C) 2016, American Megatrends, Inc.					

Feature	Description
Save Changes and Exit	Exit system setup after saving the changes. Once you are finished making your selections, choose this option from the Exit menu to ensure the values you selected are saved to the CMOS RAM. The CMOS RAM is sustained by an onboard backup battery and stays on even when the PC is turned off. When you select this option, a confirmation window appears. Select [Yes] to save changes and exit.
Discard Changes and Exit	Exit system setup without saving any changes. Select this option only if you do not want to save the changes that you made to the Setup program. If you made changes to fields other than system date, system time, and password, the BIOS asks for a confirmation before exiting.
Save Changes	Save changes done so far to any of the setup values. This option allows you to save the selections you made. After selecting this option, a confirmation appears. Select [Yes] to save any changes.
Discard Changes	Discards changes done so far to any of the setup values. This option allows you to discard the selections you made and restore the previously saved values. After selecting this option, a confirmation appears. Select [Yes] to discard any changes and load the previously saved values.
Restore Defaults	Restore Default values for all the setup values. This option allows you to load optimal default values for each of the parameters on the Setup menus, which will provide the best performance settings for your system. The F9 key can be used for this operation.



About Kontron

Kontron is a global leader in embedded computing technology (ECT). As a part of technology group S&T, Kontron offers a combined portfolio of secure hardware, middleware and services for Internet of Things (IoT) and Industry 4.0 applications. With its standard products and tailor-made solutions based on highly reliable state-of-the-art embedded technologies, Kontron provides secure and innovative applications for a variety of industries. As a result, customers benefit from accelerated time-to-market, reduced total cost of ownership, product longevity and the best fully integrated applications overall. Kontron is a listed company. Its shares are traded in the Prime Standard segment of the Frankfurt Stock Exchange and on other exchanges under the symbol "KBC". For more information, please visit: www.kontron.com / www.kontron-asia.com

▼

PRODUCT CONTACT
POINT

KONTRON ASIA INC.

4F, No. 415, Ti-Ding Blvd.,
Sec. 2, Neihu District,
Taipei, Taiwan 114741
Tel.: + 886 2 2799 2789
Fax: + 886 2 2799 7399
SalesAsia@kontron.com