

Front Panel External I/O Mechanical Layout/Drawing

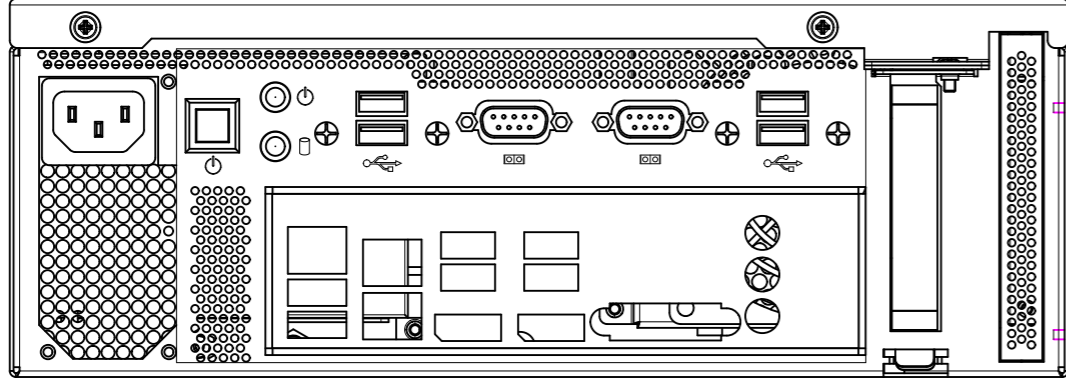

MASSTAB 1:2

Rear Panel Mechanical Layout/Drawing

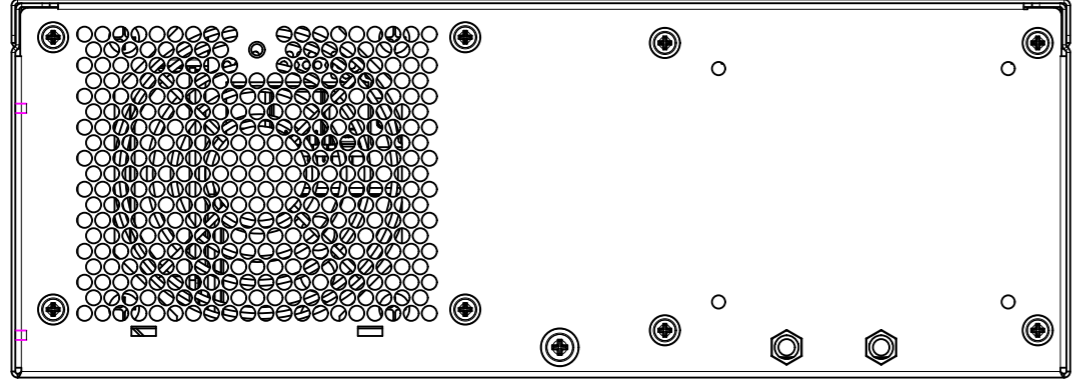

MASSTAB 1:2

MASSTAB 1:2

Schutzvermerk nach ISO 16016 beachten ! Regard proprietary right according to ISO 16016 !				Masse ohne Toleranzangabe Dim. without tolerance descrpt. ISO 2768-mK		ISO 128 Teil 1 / Part 1		Masstab/Scale: 1:5 Art./Part No.: ----	
Datum/Date: 09.07.2014 Name: Lauckner								Benennung/Title Outline KBox B101	
Zeichng./Drawing Nr.: 10100-099-00 A								Blatt/Pg. 1/3 A3	
CAD No.: 10100-000-00				Masse/Weight [Kg]: 347756491.291					

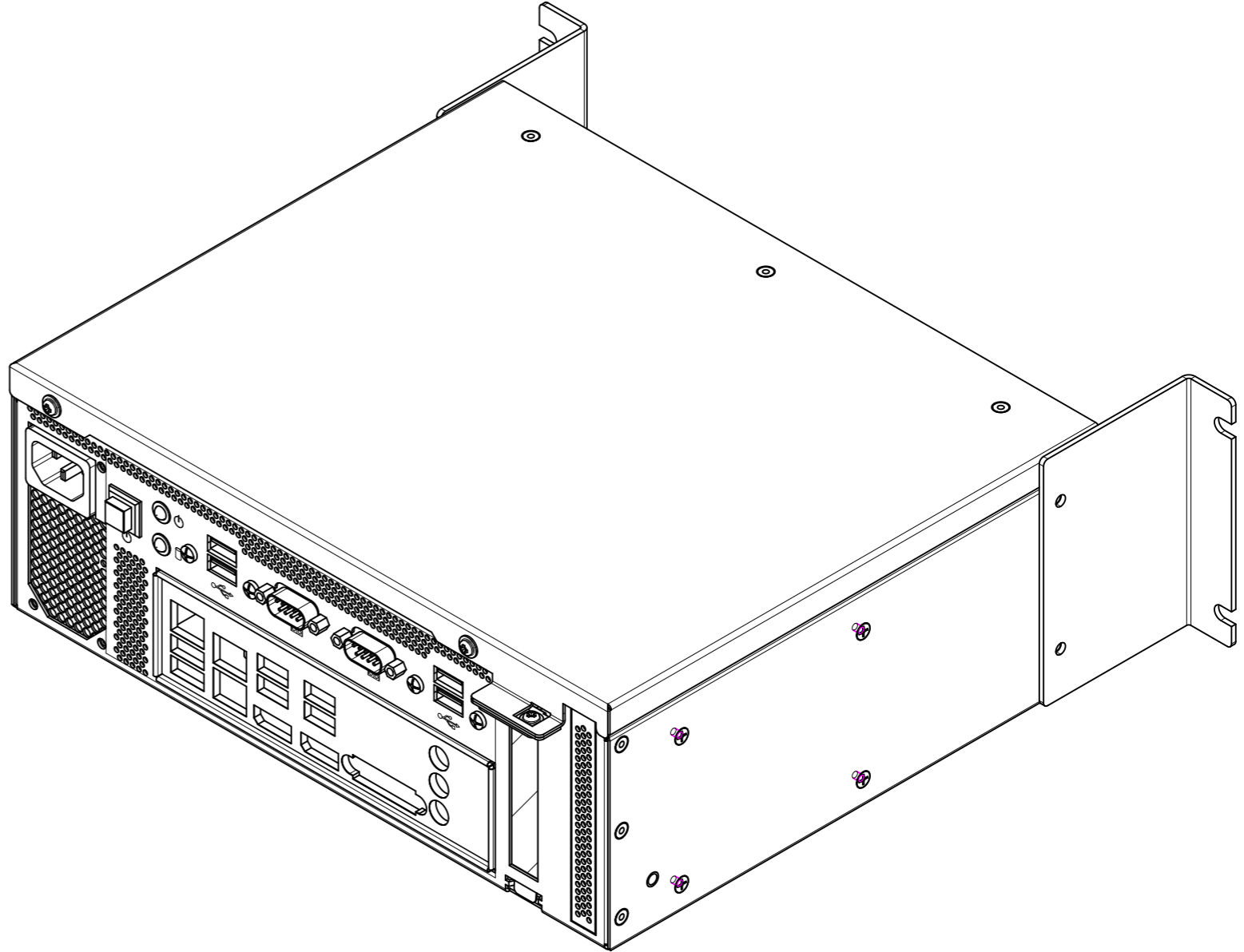
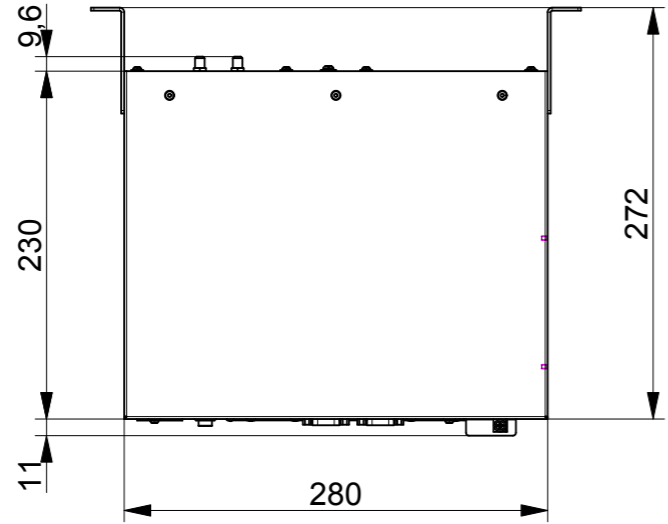
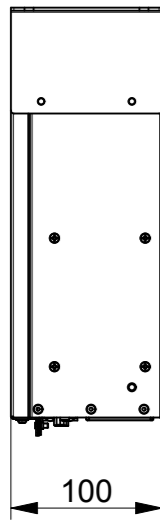
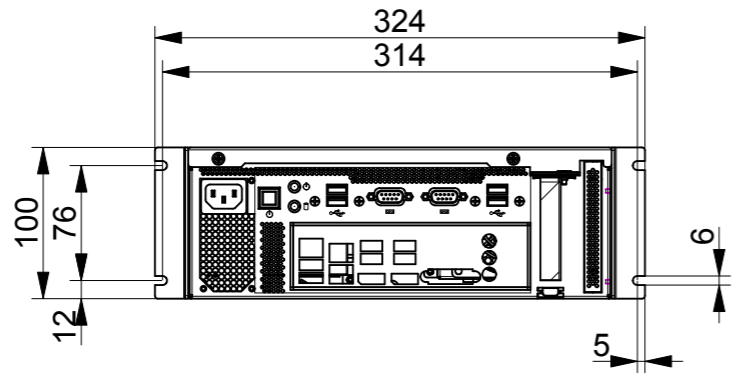

MASSTAB 1:2

Schutzvermerk nach ISO 16016 beachten ! Regard proprietary right according to ISO 16016 !					Masse ohne Toleranzangabe Dim. without tolerance descrpt. ISO 2768-mK		ISO 128 Teil 1 / Part 1		Masstab/Scale: 1:5 Art./Part No.: ----	
					Datum/Date		Name		Halbzug, Werkstoff, Oberfläche/Semifinished product, Material, Surface finish ----	
					Bearb./Draw. 09.07.2014		Lauckner		Benennung/Title <h3 style="text-align: center;">KBox B-101</h3> Variante 1	
					Gepr./Chkd.					
					Ges./Notice					
					Order 09.07.2014				Zeichng./Drawing Nr.: <h2 style="text-align: center;">10100-099-00 A</h2>	
Index Änderung/Change Datum/Date Name Order CAD No.: 10100-000-00									Masse/Weight [Kg] 347756491.291	

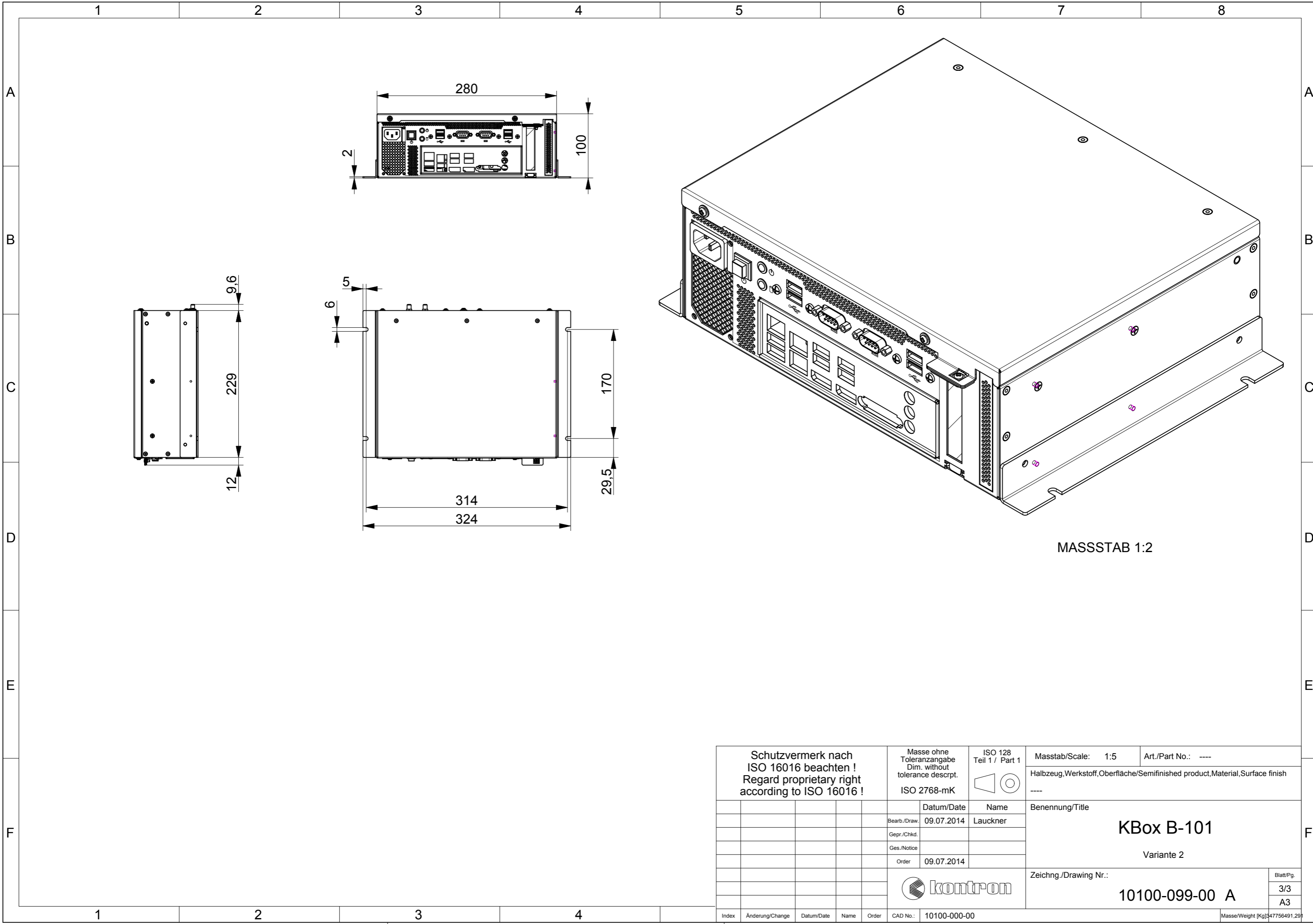

MASSTAB 1:2

Schutzvermerk nach ISO 16016 beachten ! Regard proprietary right according to ISO 16016 !					Masse ohne Toleranzangabe Dim. without tolerance descrpt. ISO 2768-mK		ISO 128 Teil 1 / Part 1		Masstab/Scale: 1:5 Art./Part No.: ----	
					Datum/Date		Name		Halbzug, Werkstoff, Oberfläche/Semifinished product, Material, Surface finish ----	
					Bearb./Draw. 09.07.2014		Lauckner		Benennung/Title <h3 style="text-align: center;">KBox B-101</h3> Variante 2	
					Gepr./Chkd.					
					Ges./Notice					
					Order 09.07.2014					
							Zeichng./Drawing Nr.:		Blatt/Pg.	
							<h3 style="text-align: center;">10100-099-00 A</h3>		3/3 A3	
Index Änderung/Change Datum/Date Name Order CAD No.: 10100-000-00									Masse/Weight [Kg] 347756491,291	